



# Section 5

## Permanent Stormwater Treatment Controls (PTPs)

---



## Section 5 – Permanent Stormwater Treatment Controls (PTP)

### 5.1 Introduction

This section presents the BMP fact sheets for Permanent Stormwater Treatment Controls (PTP). PTPs are intended to treat stormwater runoff in the long-term. Unlike many of the other BMP types, these can be designed to achieve both stormwater quantity and quality management objectives.

### 5.2 Management Practice Fact Sheets

This section contains the following BMP fact sheets.

Green Infrastructure Permanent Treatment Practice Fact Sheets			
Fact Sheet ID	Description	Fact Sheet ID	Description
GIP – 01	Bioretention	GIP – 07	Downspout Disconnection
GIP – 02	Urban Bioretention	GIP – 08	Grass Channel
GIP – 03	Permeable Pavement	GIP – 09	Sheet Flow
GIP – 04	Infiltration Trenches	GIP – 10	Reforestation
GIP – 05	Water Quality Swale	GIP – 11	Cistern
GIP – 06	Extended Detention Pond	GIP – 12	Green Roof

TSS Permanent Treatment Practice Fact Sheets			
Fact Sheet ID	Description	Fact Sheet ID	Description
TSS – 01	Stormwater Wet Ponds	TSS – 07	Grass Channels
TSS – 02	Constructed Wetlands	TSS – 08	Underground Sand Filters
TSS – 03	Surface Sand Filters	TSS – 09	Perimeter Sand Filters
TSS – 04	Water Quality Swales	TSS – 10	Organic Filters
TSS – 05	Dry Ponds	TSS – 11	Gravity (Oil-Grit) Separators
TSS – 06	Filter Strips		

Each fact sheet has a quick reference guide indicating what pollutant constituents the BMP is targeting and implementation requirements. The BMPs presented in this section are intended to serve as permanent treatment measures. Additional details are provided in sections covering Temporary Construction Site Runoff Management Practices (TCPs) for practices that are intended to function on a short-term basis (lasting only as long as construction activities) and Permanent Erosion Prevent and Sediment Control (PESC) for practices that are intended to function on a long-term basis.



## Bioretention



## GIP - 01

### Hamilton County



### Water Quality Program

**Description:** Bioretention cells are vegetated, shallow depressions. Captured runoff is treated by filtration through an engineered soil medium, and is then either infiltrated into the subsoil or exfiltrated through an underdrain. Bioretention cells may be constructed without underdrain in soils with measured infiltration rates greater than 0.5 inch per hour, and with an underdrain in less permeable soils.

#### Advantages/Benefits:

- Reduced runoff volume
- Reduced peak discharge rate
- Reduced Total Suspended Solids (TSS)
- Reduced pollutant loading
- Reduced runoff temperature
- Groundwater recharge (if soils are sufficiently permeable)
- Habitat creation
- Enhanced site aesthetics
- Reduced heat island effect

#### Disadvantages/Limitations:

- Problems with installation can lead to failure
- Minimum 2 foot separation from groundwater is required
- Suitable for pollution hotspots only with underdrain and liner

#### Design Considerations:

- Maximum contributing impervious drainage area of 2.5 acres
- Slope of drainage area = 1 – 5% or terraced to slow flow
- Building Setbacks
  - For 0 to 0.5 acre drainage area: 10 feet if down-gradient from building or level; 50 feet if up-gradient.
  - 0.5 to 2.5 acre drainage area: 25 feet if down-gradient from building or level; 100 feet if up-gradient.

#### Right of Way Applications

- Used in medians and right of way
- Stormwater can be conveyed by sheet flow or grass channels
- Pretreatment is especially important in roadway applications where sediment loads may be high
- Design as a series of cells running parallel to roadway
- See GIP-02 Urban Bioretention for additional information

#### Selection Criteria:

**Level 1 – 60% Runoff Reduction Credit**

**Level 2 – 80% Runoff Reduction Credit**

#### Land Use Considerations:

- Residential
- Commercial
- Industrial

#### Maintenance:

- Regular maintenance of landscaping to maintain healthy vegetative cover
- Irrigation when necessary during first growing season
- Periodic trash removal

M **Maintenance Burden**  
 L = Low M = Moderate H = High



## GIP - 01 SECTION 1: DESCRIPTION

Individual bioretention areas can serve impervious drainage areas of 2.5 acres or less; though several cells may be designed adjacent to each other to accommodate larger areas. Surface runoff is directed into a shallow landscaped depression that incorporates many of the pollutant removal mechanisms that operate in forested ecosystems. The primary component of a bioretention practice is the filter bed, which has a mixture of sand, soil and organic material as the filtering media typically with a surface mulch layer. During storms, runoff temporarily ponds 6 inches above the mulch layer and then rapidly filters through the bed. If the subsoil infiltration rate is 0.5 inches per hour or less, the filtered runoff is collected in an underdrain and returned to the storm drain system. The underdrain consists of a perforated pipe in a gravel layer installed along the bottom of the filter bed. Underdrains can also be installed beneath a portion of the filter bed, above a stone “sump” layer, or eliminated altogether, thereby increasing stormwater infiltration.

Bioretention can also be designed to infiltrate runoff into native soils. This can be done if the soil infiltration rate is greater than 0.5 inches per hour, the groundwater table is low, and the risk of groundwater contamination is low.

## GIP – 01 SECTION 2: PERFORMANCE

The overall runoff reduction capabilities of bioretention in terms of the Runoff Reduction Method are summarized in **Table 1.1**. Bioretention creates a good environment for runoff reduction, filtration, biological uptake, and microbial activity, and provides high pollutant removal. Bioretention can become an attractive landscaping feature with high amenity value and community acceptance.

Table 1.1. Runoff Volume Reduction Provided by Bioretention Basins		
Stormwater Function	Level 1 Design	Level 2 Design
Runoff Volume Reduction (RR)	60%	80%

Sources: CSN (2008) and CWP (2007)





## GIP – 01 SECTION 3: DESIGN TABLE

Table 1.2. Bioretention Design Criteria	
Level 1 Design (RR 60)	Level 2 Design (RR: 80)
<b>Sizing (Section 6.1)</b>	<b>Sizing (Section 6.1)</b>
<b>Surface Area (sq. ft.)</b> = (Tv – the volume reduced by an upstream BMP) / Storage Depth <sup>1</sup>	<b>Surface Area (sq. ft.)</b> = [(1.25)(Tv) – the volume reduced by an upstream BMP] /Storage Depth <sup>1</sup>
<b>Recommended maximum contributing impervious drainage area</b> = 2.5 acres	
<b>Maximum Ponding Depth</b> = 6 inches	
<b>Filter Media Depth minimum</b> = 24 inches; <b>recommended maximum</b> = 6 feet	<b>Filter Media Depth minimum</b> = 36 inches; <b>recommended maximum</b> = 6 feet
<b>Media &amp; Surface Cover (Section 6.6)</b> = mixed onsite or supplied by vendor; the final composition should be: Max 60% sand; less than 40% silt; 5% to 10% organic matter; and less than 20% clay by volume	
<b>Sub-soil Testing (Section 6.2):</b> not needed if an underdrain is used; Min infiltration rate > 0.5 inch/hour in order to remove the underdrain requirement.	<b>Sub-soil Testing (Section 6.2):</b> not needed if an underdrain is used; Min infiltration rate > 0.5 inch/hour in order to remove the underdrain requirement.
<b>Underdrain (Section 6.7)</b> = PVC or Corrugated HDPE with clean-outs <b>OR</b> , none, if soil infiltration requirements are met ( <b>Section 6.2</b> )	<b>Underdrain &amp; Underground Storage Layer (Section 6.7)</b> = PVC or Corrugated HDPE with clean outs, and a minimum 12-inch stone sump below the invert; <b>OR</b> , none, if soil infiltration requirements are met ( <b>Section 6.2</b> )
<b>Inflow:</b> sheet flow, curb cuts, trench drains, concentrated flow, or the equivalent	
<b>Geometry (Section 6.3):</b> <b>Length of shortest flow path/Overall length</b> = 0.3; <b>OR</b> , other design methods used to prevent short-circuiting; a one-cell design (not including the pre-treatment cell).	<b>Geometry (Section 6.3):</b> <b>Length of shortest flow path/Overall length</b> = 0.8; <b>OR</b> , other design methods used to prevent short-circuiting; a two-cell design (not including the pretreatment cell).
<b>Pre-treatment (Section 6.4):</b> a pretreatment cell, grass filter strip, gravel diaphragm, gravel flow spreader, or another approved (manufactured) pre-treatment structure.	<b>Pre-treatment (Section 6.4):</b> a pretreatment cell plus one of the following: a grass filter strip, gravel diaphragm, gravel flow spreader, or another approved (manufactured) pre-treatment structure.
<b>Conveyance &amp; Overflow (Section 6.5)</b>	
<b>Planting Plan (Section 6.8):</b> a planting template to include perennials, grasses, sedges or shrubs to achieve a surface area coverage <sup>3</sup> of at least 75% within 2 years by using the recommended spacing in <b>Tables 1.3 – 1.8</b>	<b>Planting Plan (Section 6.8):</b> a planting template to include perennials, grasses, sedges, and shrubs to achieve surface area coverage of at least 75% within 2 years by using the recommended spacing in <b>Tables 1.3 – 1.8. MUST</b> also include trees planted at 1 tree/400 s.f.
<b>Suggested Building Setbacks<sup>2</sup> (Section 5):</b>	
0 to 0.5 acre CDA = 10 feet if down-gradient from building or level; 50 feet if up-gradient. 0.5 to 2.5 acre CDA = 25 feet if down-gradient from building or level; 100 feet if up-gradient. (Refer to additional setback criteria in <b>Section 5</b> )	
<b>Long Term Maintenance Requirements (Section 10)</b>	

<sup>1</sup> Storage depth is the sum of the porosity (n) of the soil media and gravel layers multiplied by their respective depths, plus the surface ponding depth. Refer to GIP – 01 **Section 6.1**.

<sup>2</sup>These are recommendations for simple building foundations. If an in-ground basement or other special conditions exist, the design should be reviewed by a licensed engineer.

<sup>3</sup>Surface area coverage in reference to planting is the percentage of vegetative cover in a planting area.



The most important design factor to consider when applying bioretention to development sites is the **scale** at which it will be applied, as follows:

**Rain Gardens.** These are small, distributed practices designed to treat runoff from small areas, such as individual rooftops, driveways and other on-lot features in single-family detached residential developments. Inflow is typically sheet flow, or can be concentrated flow with energy dissipation, when located at downspouts. Rain gardens do not currently count toward a runoff reduction credit. Please see [www.raingardensfornashville.com](http://www.raingardensfornashville.com) for more information on residential rain garden construction.

**Bioretention Basins.** These are structures treating parking lots and/or commercial rooftops, usually in commercial or institutional areas. Throughout this GIP bioretention basins are simply referred to as Bioretention. Inflow can be either sheet flow or concentrated flow. Bioretention basins may also be distributed throughout a residential subdivision, but they should be located in common areas and within drainage easements, to treat a combination of roadway and lot runoff.

The major design goal for bioretention is to maximize runoff volume reduction and pollutant removal. To this end, designers may choose to go with the baseline design (Level 1) or choose an enhanced design (Level 2) that maximizes pollutant and runoff reduction. If soil conditions require an underdrain, bioretention areas can still qualify for the Level 2 design if they contain a stone storage layer beneath the invert of the underdrain.

**Table 1.2** outlines the Level 1 and 2 bioretention design guidelines. Local simulation modeling supports these runoff reduction credits for the mentioned contributing drainage area (CDA) to surface area ratios.

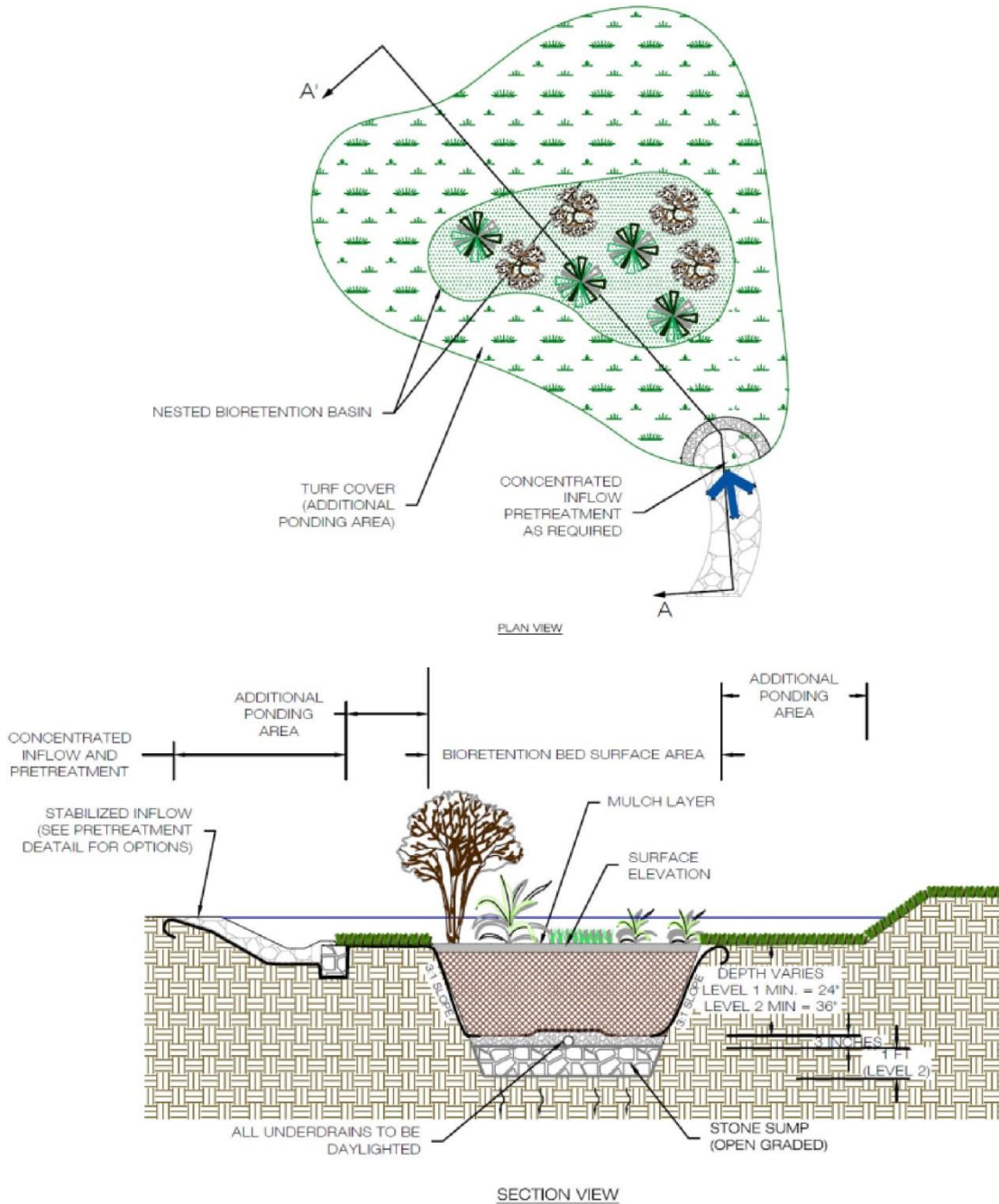


**Figure GIP-01-01. A typical Bioretention Basin treating a commercial rooftop**



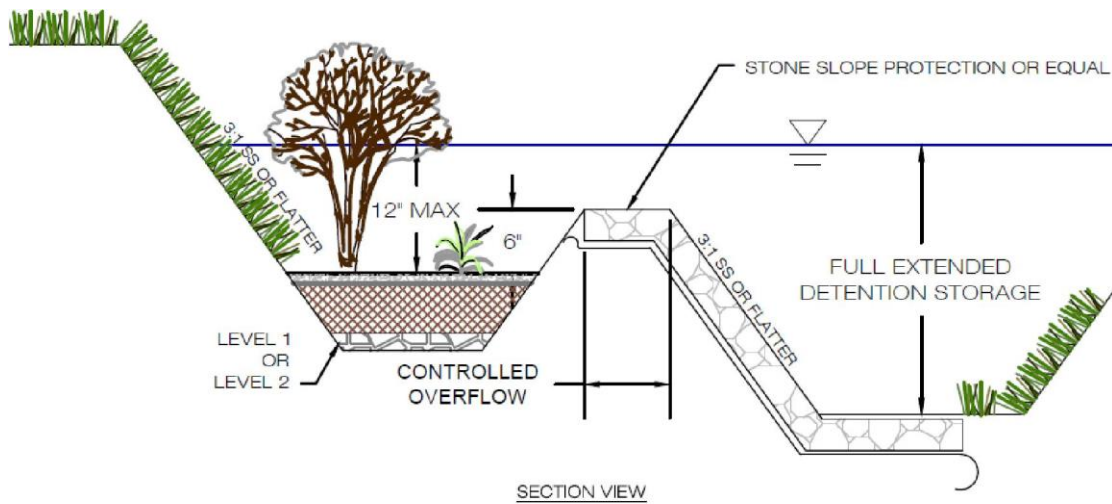
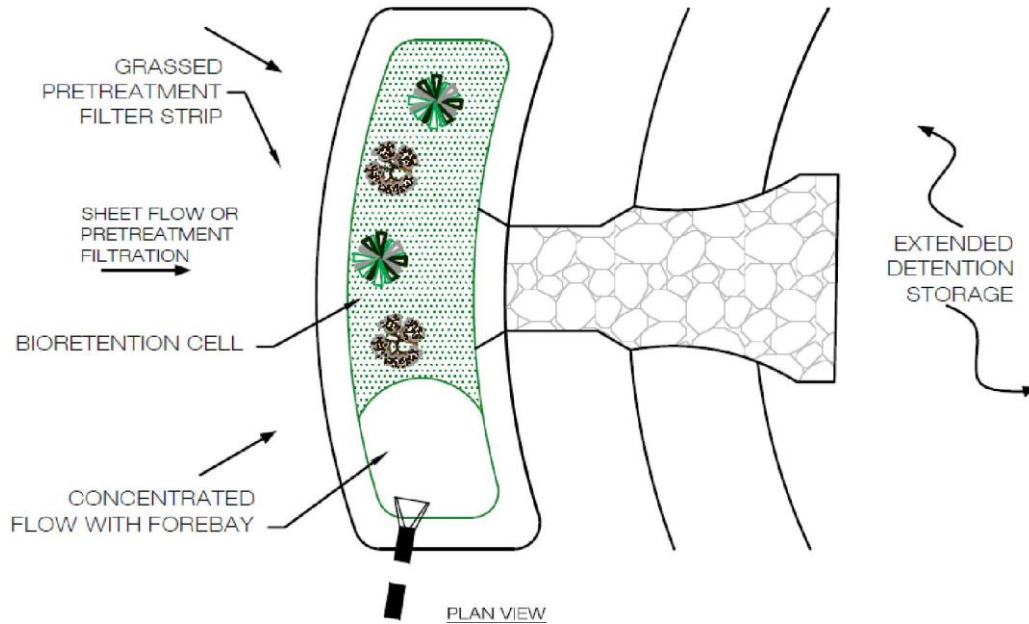
**GIP – 01 SECTION 4: TYPICAL DETAILS**

Figures GIP-01-02 through GIP-01-06 provide some typical details for several bioretention configurations. Additional details are provided in Appendix 1-B of this design specification.



**Figure GIP-01-02. Typical Detail of Bioretention with Additional Surface Ponding (source: VADCR, 2010)**





**BIORETENTION IN SHELF OF EXTENDED DETENTION POND**

NTS

**Figure GIP-01-03. Typical Detail of a Bioretention Basin within the Upper Shelf of an ED Pond (source: VADCR, 2010)**



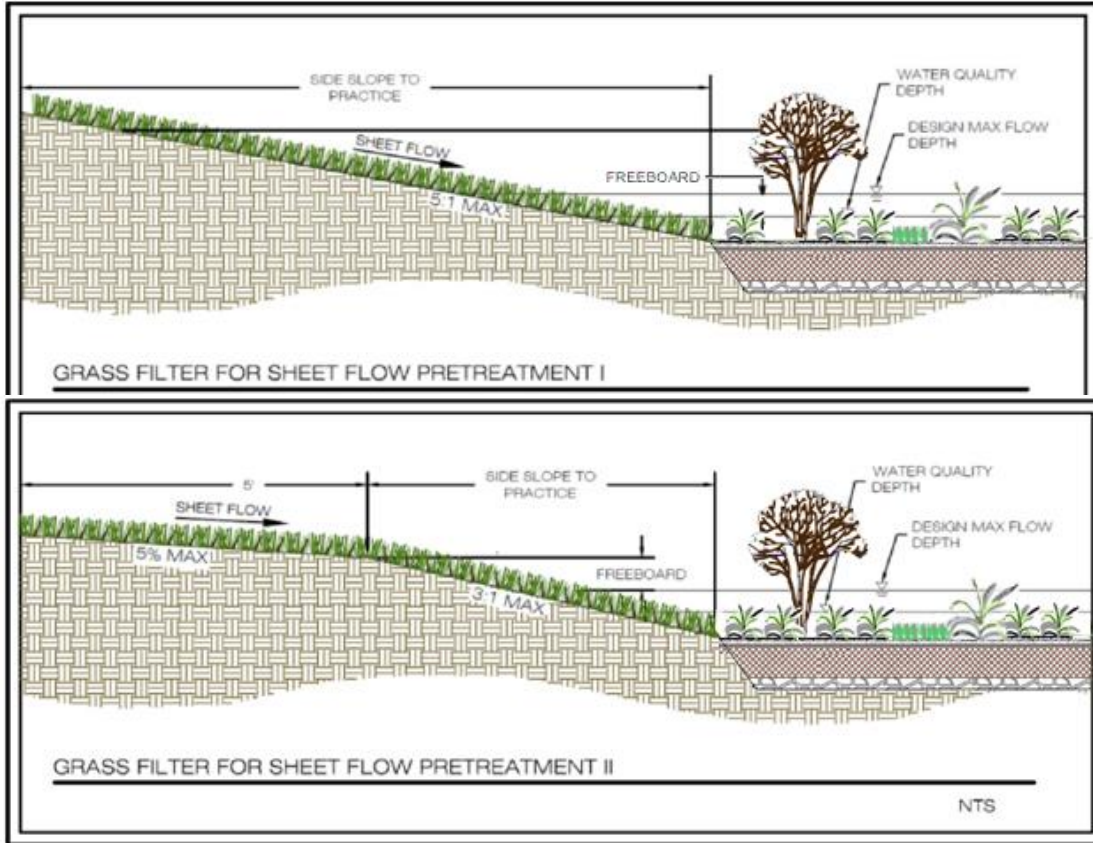


Figure GIP-01-04. Pretreatment Option - Grass Filter for Sheet Flow (source: VADCR, 2010)

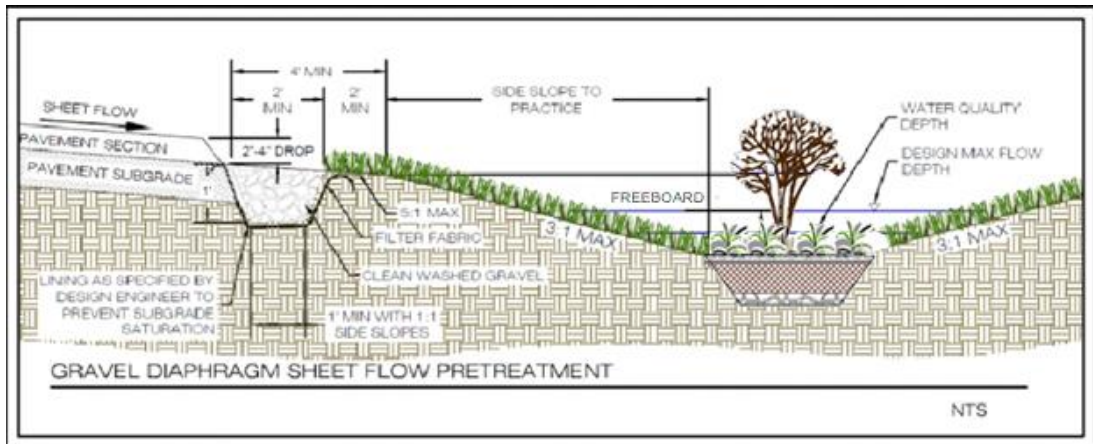
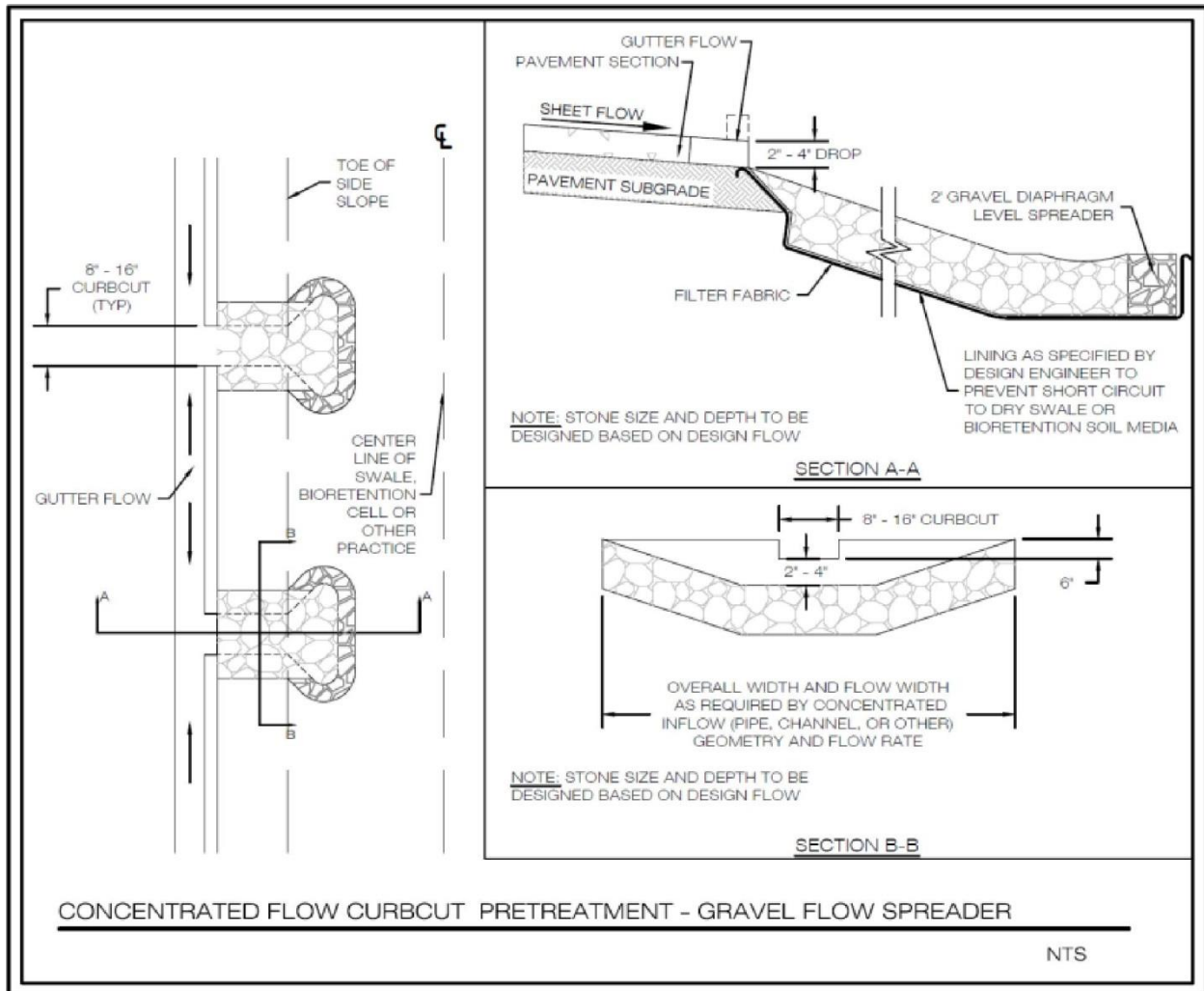


Figure GIP-01-05. Pretreatment Option – Gravel Diaphragm for Sheet (source: VADCR, 2010)



**Figure GIP-01-06. Pre-Treatment Option – Gravel Flow Spreader for Concentrated Flow Outside of ROW (source: VADCR, 2010)**



## GIP – 01 SECTION 5: PHYSICAL FEASIBILITY & DESIGN APPLICATIONS

### 5.1 Physical Feasibility

Bioretention can be applied in most soils or topography, since runoff simply percolates through an engineered soil bed and can be returned to the stormwater system if the infiltration rate of the underlying soils is low. Key constraints with bioretention include the following:

**Available Space.** Planners and designers can assess the feasibility of using bioretention facilities based on a simple relationship between the contributing drainage area and the corresponding required surface area. The bioretention surface area will be approximately 3% to 10% of the contributing drainage area, depending on the imperviousness of the contributing drainage area (CDA), the subsoil infiltration rate, and the desired bioretention design level.

**Site Topography.** Bioretention is best applied when the grade of contributing slopes is greater than 1% and less than 5%. Terracing or other inlet controls may be used to slow runoff velocities entering the facility.

**Available Hydraulic Head.** Bioretention is fundamentally constrained by the invert elevation of the existing conveyance system to which the practice discharges (i.e., the bottom elevation needed to tie the underdrain from the bioretention area into the storm drain system). In general, 3 feet of elevation above this invert is needed to create the hydraulic head needed to drive stormwater through a proposed bioretention filter bed. Less hydraulic head is needed if the underlying soils are permeable enough to dispense with the underdrain.

**Water Table.** Bioretention should always be separated from the water table to ensure that groundwater does not intersect the filter bed. Mixing can lead to possible groundwater contamination or failure of the bioretention facility. A separation distance of 2 feet is recommended between the bottom of the excavated bioretention area and the seasonally high ground water table.

**Utilities.** Designers should ensure that future tree canopy growth in the bioretention area will not interfere with existing overhead utility lines. Interference with underground utilities should also be avoided, particularly water and sewer lines. Local utility design guidance should be consulted in order to determine the horizontal and vertical clearance required between stormwater infrastructure and other dry and wet utility lines.

**Soils.** Soil conditions do not constrain the use of bioretention, although they determine whether an underdrain is needed. Impermeable soils in Hydrologic Soil Group (HSG) C or D usually require an underdrain, whereas HSG A soils and most HSG B soils generally do not. Initially, soil infiltration rates can be estimated from NRCS soil data, but they must be confirmed by an on-site infiltration evaluation (See Appendix 1-A).

**Contributing Drainage Area.** Bioretention works best with smaller contributing drainage areas, where it is easier to achieve flow distribution over the filter bed without experiencing erosive velocities and excessive ponding times. Typical drainage area size can range from 0.1 to 2.5 acres of impervious cover due to limitations on the ability of bioretention to effectively manage large volumes and peak rates of runoff. However, if hydraulic considerations are adequately addressed to manage the potentially large peak inflow of larger drainage areas (such as off-line or low-flow diversions, forebays, etc.), there may be case-by-case instances where the Program may allow these recommended maximums to be adjusted. In such cases, the bioretention facility should be located within the drainage area so as to capture the Treatment Volume ( $T_v$ ) equally from the entire contributing area, and not fill the entire volume from the immediately adjacent area, thereby bypassing the runoff from the





more remote portions of the site.

**Hotspot Land Uses.** Runoff from hotspot land uses should not be treated with infiltrating bioretention (i.e., constructed *without* an underdrain). For a list of potential stormwater hotspots, please consult **Section 11.1**. An impermeable bottom liner and an underdrain system may be employed, with the Program approval, when bioretention is used to receive and treat hotspot runoff.

**Floodplains.** Bioretention areas should be constructed outside the limits of the 100-year floodplain.

**No Irrigation or Baseflow.** The planned bioretention area should not receive baseflow, irrigation water, chlorinated wash-water or other such non-stormwater flows that are not stormwater runoff, except for irrigation as necessary for the survival of plantings within the bioretention area.

**Setbacks.** To avoid the risk of seepage, follow prescribed setbacks which attempt to prevent bioretention area infiltration from flow towards structure foundations or pavement. Setbacks to structures and roads vary, based on the scale of the bioretention design (see **Table 1.2** above). At a minimum, bioretention basins should be located a horizontal distance of 100 feet from any water supply well, 50 feet from septic systems, and at least 5 feet from down-gradient wet utility lines. Dry utility lines such as electric, cable and telephone may cross under bioretention areas if they are double-cased. Bioretention basins can be constructed closer to structures and roads if an impermeable barrier is placed between the basin and the structure or roadway. Please see **GIP-02** for additional information on ROW applications.

## 5.2 Potential Bioretention Applications

Bioretention can be used wherever water can be conveyed to a surface area. Bioretention has been used at commercial, institutional and residential sites in spaces that are traditionally pervious and landscaped. It should be noted that special care must be taken to provide adequate pre-treatment for bioretention cells in space-constrained high traffic areas. Typical locations for bioretention include the following:

**Parking lot islands.** The parking lot grading is designed for sheet flow towards linear landscaping areas and parking islands between rows of spaces. Curb-less pavement edges can be used to convey water into a depressed island landscaping area. Curb cuts can also be used for this purpose, but they are more prone to blockage, clogging and erosion. Curb openings shall be at least 18 inches wide to minimize clogging.

**Parking lot edge.** Small parking lots can be graded so that flows reach a curb-less pavement edge or curb cut before reaching catch basins or storm drain inlets. The turf at the edge of the parking lot functions as a filter strip to provide pre-treatment for the bioretention practice. The depression for bioretention is located in the pervious area adjacent to the parking lot.

**Right of Way or commercial setback.** A linear configuration can be used to convey runoff in sheet flow from the roadway, or a grass channel or pipe may convey flows to the bioretention practice.

**Courtyards.** Runoff collected in a storm drain system or roof leaders can be directed to courtyards or other pervious areas on site where bioretention can be installed.





**Unused pervious areas on a site.** Storm flows can be redirected from a storm drain pipe to discharge into a bioretention area.

**Dry Extended Detention (ED) basin.** A bioretention cell can be located on an upper shelf of an extended detention basin, after the sediment forebay, in order to boost treatment. Depending on the ED basin design, the designer may choose to locate the bioretention cell in the bottom of the basin. However, the design must carefully account for the potentially deeper ponding depths (greater than 6 or 12 inches) associated with extended detention.

**Retrofitting.** Numerous options are available to retrofit bioretention in the urban landscape. Some are described in **GIP-02, Urban Bioretention.**

## GIP – 01 SECTION 6: DESIGN CRITERIA

### 6.1 Sizing of Bioretention Practices

#### 6.1.1 Stormwater Quality

Sizing of the surface area (SA) for bioretention practices is based on the computed Treatment Volume ( $T_v$ ) of the contributing drainage area and the storage provided in the facility. The required surface area (in square feet) is computed as the Treatment Volume (in cubic feet) divided by the equivalent storage depth (in feet). The equivalent storage depth is computed as the depth of media, gravel, or surface ponding (in feet) multiplied by the accepted porosity.

The accepted porosities (n) are (see **Figure GIP-01-07** below):

Bioretention Soil Media (See <b>Section 6.6</b> )	n = 0.40
Gravel	n = 0.40
Surface Storage	n = 1.0

The equivalent storage depth for Level 1 with a 6-inch surface ponding depth is therefore computed as:

#### **Equation GIP-01-01. Bioretention Level 1 Design Storage Depth**

$$\text{Equivalent Storage Depth} = D_E = n_1(D_1) + n_2(D_2) + \dots$$

$$D_E = (2 \text{ ft.} \times 0.40) + (0.5 \times 1.0) = 1.30 \text{ ft.}$$

Where  $n_1$  and  $D_1$  are for the first layer, etc.

The equivalent storage depth for Level 2 with 3 ft. of media, a 6-inch surface ponding depth and a 12-inch gravel layer is computed as:

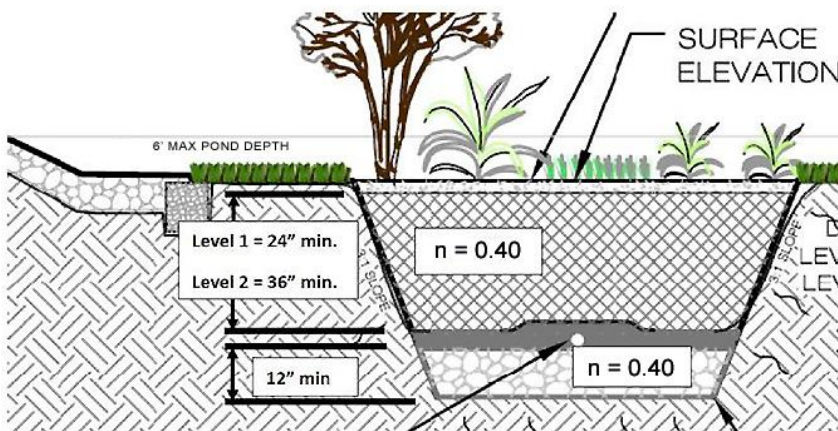
#### **Equation GIP-01-02. Bioretention Level 2 Design Storage Depth**

$$D_E = (3 \text{ ft.} \times 0.40) + (1 \text{ ft.} \times 0.40) + (0.5 \times 1.0) = 2.10 \text{ ft.}$$

While this method is simplistic, simulation modeling has proven that it yields a total storage volume somewhat equivalent to 80% total average rainfall volume removal for infiltration rates from 0.5 in/hr. through 1.2 in/hr. If the designer can show a measured subsurface infiltration rate above this value size decreases may be requested



on a case-by-case basis.



**Figure GIP-01-07. Typical Level 2 Bioretention Section with Porosities for Volume Computations**

Therefore, the Level 1 Bioretention Surface Area (SA) is computed as:

**Equation GIP-01-03. Bioretention Level 1 Design Surface Area**  

$$SA \text{ (sq. ft.)} = (T_v - \text{the volume reduced by an upstream BMP}) / D_E$$

And the Level 2 Bioretention Surface Area is computed as:

**Equation GIP-01-04. Bioretention Level 2 Design Surface Area**  

$$SA \text{ (sq. ft.)} = [(1.25 * T_v) - \text{the volume reduced by an upstream BMP}] / D_E$$

Where:

SA = Minimum surface area of bioretention filter (sq. ft.)

$D_E$  = Equivalent Storage Depth (ft.)

$T_v$  = Treatment Volume (cu. ft.) = [(1.0 in.)( $R_v$ )(A)\*3630]

Where: A = Area in acres

(NOTE:  $R_v$  = the composite runoff coefficient from the RR Method. A table of  $R_v$  values and the equation for calculating a composite  $R_v$  is located in Section 2.3.3 of this manual)

Equations 1.1 through 1.4 should be modified if the storage depths of the soil media (Max. 2–6 ft.), gravel layer, or ponded water (Max. 0.5 ft.) vary in the actual design or with the addition of any surface or subsurface storage components (e.g., additional area of surface ponding, subsurface storage chambers, etc.).

### 6.1.2 Stormwater Quantity

Designers may be able to create additional surface storage by expanding the surface ponding footprint in order to accommodate a greater quantity credit for channel and/or flood protection, without necessarily increasing the soil media footprint. In other words, the engineered soil media would only underlay part of the surface area of the bioretention (see **Figure GIP-01-02**).

In this regard, the ponding footprint can be increased as follows to allow for additional storage:



- ❖ 50% surface area increase if the ponding depth is 6 inches or less.
- ❖ 25% surface area increase if the ponding depth is between 6 and 12 inches.

These values may be modified as additional data on the long term permeability of bioretention filters becomes available.

The removal of volume by bioretention changes the runoff depth entering downstream flood control facilities. An approximate approach to accounting for this in reducing the size of peak flow detention facilities is to calculate an “effective SCS curve number” ( $CN_{adj}$ ), which is less than the actual curve number (CN).  $CN_{adj}$  can then be used in hydrologic calculations and in routing. The method can also be used for other hydrologic methods in which a reduction in runoff volume is possible.

### 6.2 Soil Infiltration Rate Testing

In order to determine if an underdrain will be needed, one must measure the infiltration rate of subsoils at the invert elevation of the bioretention area. The infiltration rate of subsoils must exceed 0.5 inch per hour for bioretention basins. On-site soil infiltration rate testing procedures are outlined in **Appendix 1-A**. The number of soil tests varies base on the size of the bioretention area:

- ❖  $< 1,000 \text{ ft}^2 = 2 \text{ tests}$
- ❖  $1,000 - 10,000 \text{ ft}^2 = 4 \text{ tests}$
- ❖  $>10,000 \text{ ft}^2 = 4 \text{ tests} + 1 \text{ test for every additional } 5,000 \text{ ft}^2$

Soil testing is not needed for Level 1 bioretention areas where an underdrain is used. If an underdrain with a gravel sump is used for Level 2, the bottom of the sump must be at least two feet above bedrock and the seasonally high groundwater table.

### 6.3 BMP Geometry

Bioretention basins must be designed with internal flow path geometry such that the treatment mechanisms provided by the bioretention are not bypassed or short-circuited. Examples of short-circuiting include inlets or curb cuts that are very close to outlet structures (see **Figure 1.8**), or incoming flow that is diverted immediately to the underdrain through stone layers. Short-circuiting can be particularly problematic when there are multiple curb cuts or inlets.



**Figure GIP-01-08. Examples of Short-Circuiting at Bioretention Facilities (source: VADCR, 2010)**

In order for these bioretention areas to have an acceptable internal geometry, the “travel time” from each inlet to the outlet should be maximized, and incoming flow must be distributed as evenly as possible across the filter surface area.





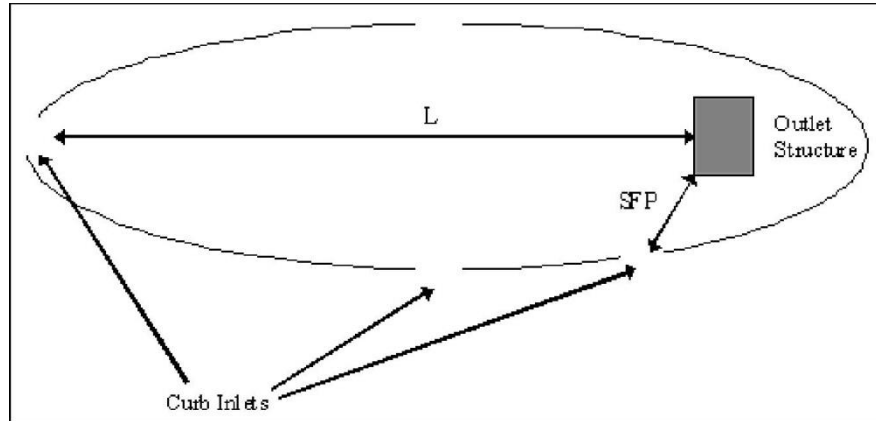
One important characteristic is the length of the shortest flow path compared to the overall length, as shown in **Figure 1.9** below. In this figure, the ratio of the shortest flow path to the overall length is represented as:

$$\text{Equation GIP-01-05. Ratio of Shortest Flow Path to Overall Length} \\ SFP / L$$

Where:

$SFP$  = length of the shortest flow path

$L$  = length from the most distant inlet to the outlet

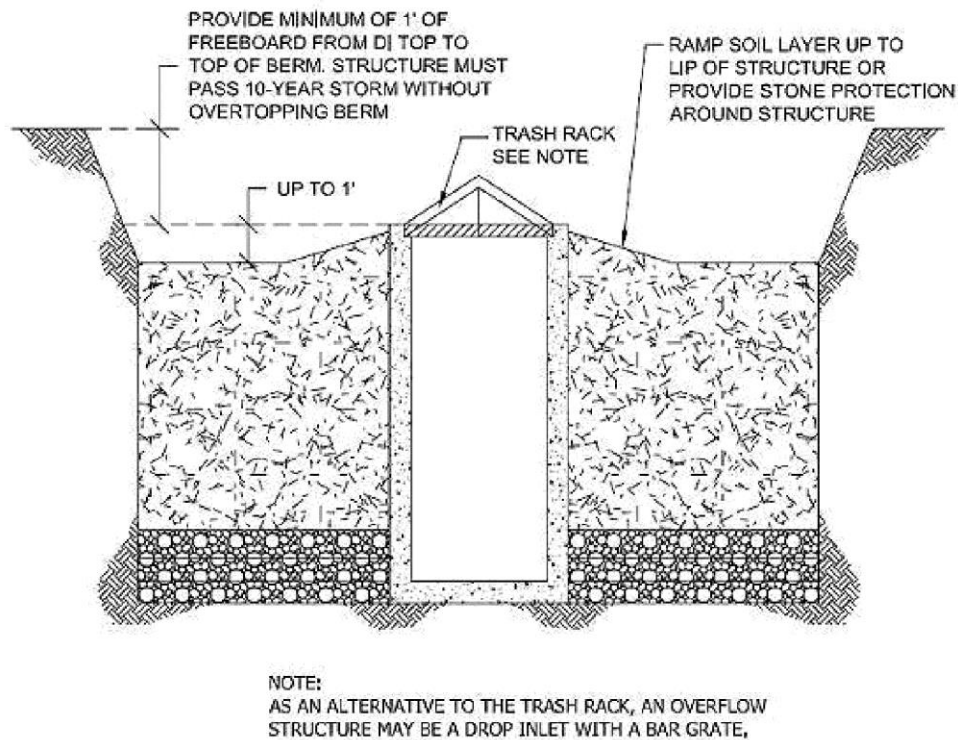


**Figure GIP-01-09. Diagram showing shortest flow path as part of BMP geometry (source: VADCR, 2010)**

For Level 1 designs, the  $SFP/L$  ratio must be 0.3 or greater; the ratio must be 0.8 or greater for Level 2 designs. In some cases, due to site geometry, some inlets may not be able to meet these ratios. However, the drainage area served by such inlets should constitute no more than 20% of the contributing drainage area. Alternately, the designer may incorporate other design features that prevent short-circuiting, including features that help spread and distribute runoff as evenly as possible across the filter surface.

Field experience has shown that soil media immediately around a raised outlet structure is prone to scouring and erosion, thus, short-circuiting of the treatment mechanism. For example, water can flow straight down through scour holes or sinkholes to the underdrain system (Hirschman et al., 2009). Design options should be used to prevent this type of scouring. The designer should ensure that incoming flow is spread as evenly as possible across the filter surface to maximize the treatment potential. One example is shown in **Figure GIP-01-10**.





**Figure GIP-01-10. Typical Detail of how to prevent bypass or short-circuiting around the overflow structure (source: VADCR, 2010)**

#### 6.4 Pre-treatment

Pre-treatment of runoff entering bioretention areas is necessary to trap coarse sediment particles before they reach and prematurely clog the filter bed. Pre-treatment measures must be designed to evenly spread runoff across the entire width of the bioretention area. Several pre-treatment measures are feasible, depending on the scale of the bioretention practice and whether it receives sheet flow, shallow concentrated flow or deeper concentrated flows. The following are appropriate pretreatment options:

##### **For Bioretention Basins:**

- ❖ **Pre-treatment Cells** (channel flow): Similar to a forebay, this cell is located at piped inlets or curb cuts leading to the bioretention area and consists of an energy dissipater sized for the expected rates of discharge. It has a storage volume equivalent to at least 15% of the total Treatment Volume (inclusive) with a 2:1 length-to-width ratio. The cell may be formed by a wooden or stone check dam or an earthen or rock berm. Pretreatment cells do not need underlying engineered soil media, in contrast to the main bioretention cell.
- ❖ **Grass Filter Strips** (sheet flow): Grass filter strips extend from the edge of pavement to the bottom of the bioretention basin at a 5:1 slope or flatter. Alternatively, provide a combined 5 feet of grass filter strip at a maximum 5% (20:1) slope and 3:1 or flatter side slopes on the bioretention basin. (See Figure GIP-01-04)
- ❖ **Gravel or Stone Diaphragms** (sheet flow). A gravel diaphragm located at the edge of the pavement should be oriented perpendicular to the flow path to pre-treat lateral runoff, with a 2 to 4 inch drop. The stone must be sized according to the expected rate of discharge. (See Figure GIP-01-05)



- ❖ **Gravel or Stone Flow Spreaders** (concentrated flow). The gravel flow spreader is located at curb cuts, downspouts, or other concentrated inflow points, and should have a 2 to 4 inch elevation drop from a hard-edged surface into a gravel or stone diaphragm. The gravel should extend the entire width of the opening and create a level stone weir at the bottom or treatment elevation of the basin. (See **Figure GIP-01-06**)
- ❖ **Innovative or Proprietary Structure:** An approved proprietary structure with demonstrated capability of reducing sediment and hydrocarbons may be used to provide pre-treatment.

### 6.5 Conveyance and Overflow

**For On-line bioretention:** An overflow structure should always be incorporated into on-line designs to safely convey larger storms through the bioretention area. The following criteria apply to overflow structures:

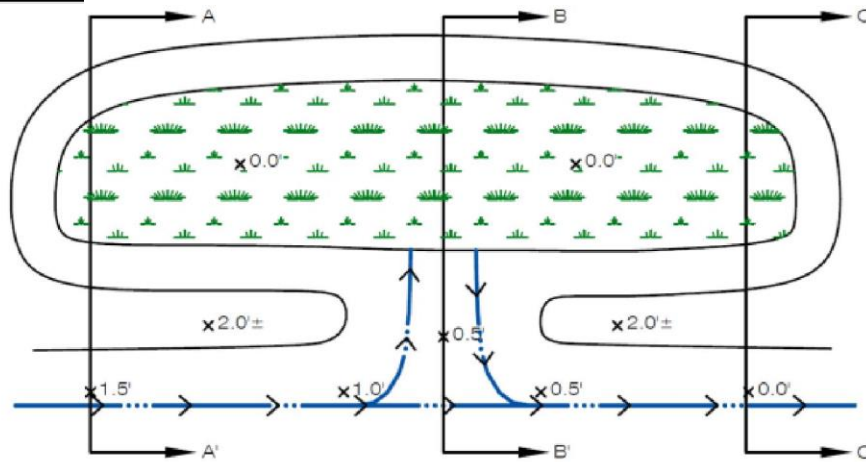
- ❖ The overflow associated with the 100 year design storms should be controlled so that velocities are non-erosive at the outlet point (i.e., to prevent downstream erosion).
- ❖ Common overflow systems within bioretention practices consist of an inlet structure, where the top of the structure is placed at the maximum water surface elevation of the bioretention area, which is typically 6 inches above the surface of the filter bed.
- ❖ The overflow capture device (typically a yard inlet) should be scaled to the application – this may be a landscape grate inlet or a commercial-type structure.
- ❖ The filter bed surface should generally be flat so the bioretention area fills up like a bathtub.

**Off-line bioretention:** Off-line designs are preferred (see **Figure GIP-01-11** for an example). One common approach is to create an alternate flow path at the inflow point into the structure such that when the maximum ponding depth is reached, the incoming flow is diverted past the facility. In this case, the higher flows do not pass over the filter bed and through the facility, and additional flow is able to enter as the ponding water filtrates through the soil media.

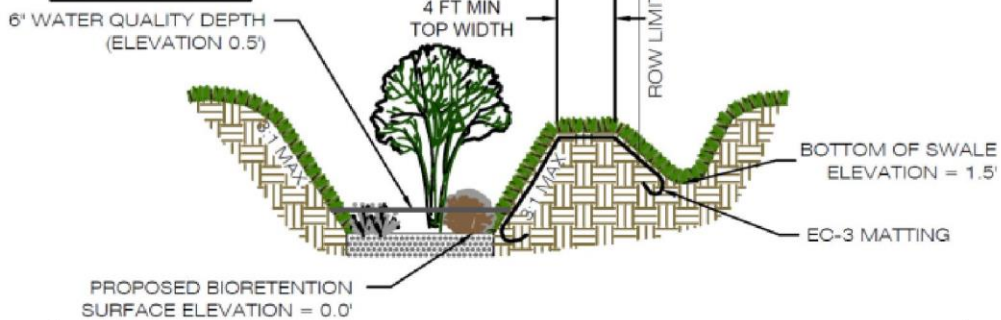
Another option is to utilize a low-flow diversion or flow splitter at the inlet to allow only the Treatment Volume to enter the facility. This may be achieved with a weir or curb opening sized for the target flow, in combination with a bypass channel. Using a weir or curb opening helps minimize clogging and reduces the maintenance frequency.



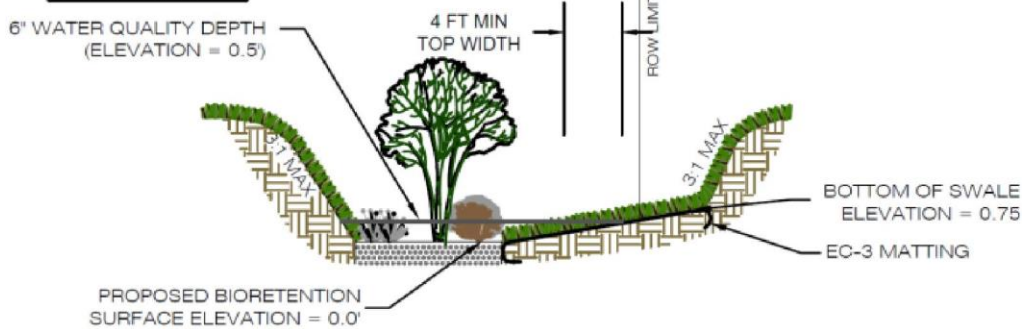
**PLAN VIEW**



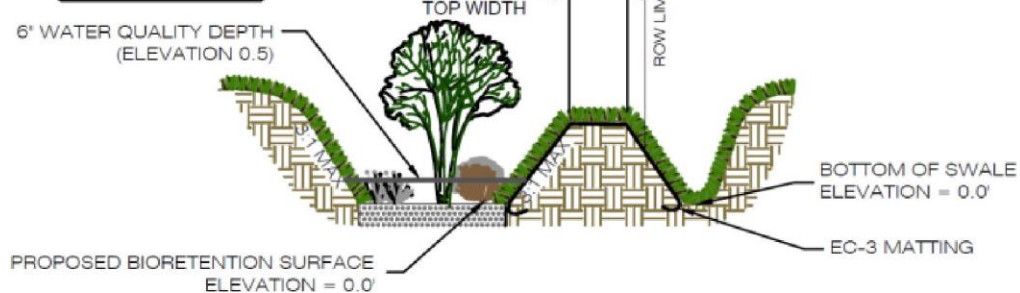
**SECTION A-A'**



**SECTION B-B'**



**SECTION C-C'**



**Figure GIP-01-11. Typical Details for Off-Line Bioretention (source: VADCR, 2010)**





## 6.6 Filter Media and Surface Cover

- ❖ The filter media and surface cover are the two most important elements of a bioretention facility in terms of long-term performance. The following are key factors to consider in determining an acceptable soil media mixture.
- ❖ **General Filter Media Composition.** The recommended bioretention soil mixture is generally classified as a loamy sand on the USDA Texture Triangle, with the following composition by volume:
  - Maximum 60% sand;
  - Less than 40% silt;
  - 5% to 10% organic matter; and
  - Less than 20% clay

It may be advisable to start with an open-graded coarse sand material and proportionately mix in topsoil that will likely contain anywhere from 30% to 50% soil fines (sandy loam, loamy sand) to achieve the desired ratio of sand and fines. An additional 5% to 10% organic matter can then be added. (The exact composition of organic matter and topsoil material will vary, making particle size distribution and recipe for the total soil media mixture difficult to define in advance of evaluating the available material.)

- ❖ **Cation Exchange Capacity (CEC).** The CEC of a soil refers to the total amount of positively charged elements that a soil can hold; it is expressed in milliequivalents per 100 grams (meq/100g) of soil. For agricultural purposes, these elements are the basic cations of calcium ( $\text{Ca}^{2+}$ ), magnesium ( $\text{Mg}^{2+}$ ), potassium ( $\text{K}^+$ ) and sodium ( $\text{Na}^+$ ) and the acidic cations of hydrogen ( $\text{H}^+$ ) and aluminum ( $\text{Al}^+$ ). The CEC of the soil is determined in part by the amount of clay and/or humus or organic matter present. Soils with CECs exceeding 10 meq/100g are preferred for pollutant removal. Increasing the organic matter content of any soil will help to increase the CEC, since it also holds cations like the clays.
- ❖ **Infiltration Rate.** The bioretention soil media should have a minimum infiltration rate of 1 to 2 inches per hour (a proper soil mix will have an initial infiltration rate that is significantly higher).
- ❖ **Depth.** The standard minimum filter bed depth ranges from 24 and 36 inches for Level 1 and Level 2 designs, respectively. If trees are included in the bioretention planting plan, tree planting holes in the filter bed should be deeper to provide enough soil volume for the root structure of mature trees. Use turf, perennials or shrubs instead of trees to landscape shallower filter beds.
- ❖ **Mulch.** A 3 inch layer of mulch on the surface of the filter bed enhances plant survival, suppresses weed growth, and pre-treats runoff before it reaches the filter media. Shredded, aged hardwood mulch or pine straw make very good surface cover, as they retains a significant amount of nitrogen and typically will not float away.
- ❖ **Alternative to Mulch Cover.** In some situations, designers may consider alternative surface covers such as turf, native groundcover, erosion control matting (coir or jute matting), river stone, or pea gravel. The decision regarding the type of surface cover to use should be based on function, cost and maintenance.





### 6.7 Underdrain and Underground Storage Layer

Level 1 design require an underdrain surrounded by a jacket of 1 inch stone unless the infiltration rate of the surrounding soils is greater than 0.5 inches per hour. Some Level 2 designs will not use an underdrain (where soil infiltration rates meet minimum standards; see **Section 6.2** and **Table GIP-01-02**). For Level 2 designs with an underdrain, an underground storage layer of 12-18 inches should be incorporated below the invert of the underdrain. The depth of the storage layer will depend on the target treatment and storage volumes needed to meet water quality criteria. However, the bottom of the storage layer must be at least 2 feet above the seasonally high water table and bedrock. The storage layer should consist of clean, washed #57 stone or an approved infiltration module.

All bioretention basins should include observation wells. The observation wells should be tied into any T's or Y's in the underdrain system, and should extend upwards to be flush with the surface, with a vented cap. In addition, cleanout pipes should be provided if the contributing drainage area exceeds 1 acre.

### 6.8 Bioretention Planting Plans

A landscaping plan must be provided for each bioretention area. Minimum plan elements shall include the proposed bioretention template to be used, delineation of planting areas, the planting plan, including the size, the list of planting stock, sources of plant species, and the planting sequence, including post-nursery care and initial maintenance requirements. The planting area is defined as the area disturbed by construction events. The planting plan must address 100% of the planting area. It is highly recommended that the planting plan be prepared by a qualified landscape architect, in order to tailor the planting plan to the site-specific conditions.

Native plant species are preferred over non-native species, but some ornamental species may be used for landscaping effect if they are not aggressive or invasive. **Tables 1.4 – 1.8** list native plant species suitable for use in bioretention.

The planting template refers to the form and combination of native trees, shrubs, and perennial ground covers that maintain the appearance and function of the bioretention area. Planting templates may be of the following types:

- ❖ **Ornamental planting.** This option includes perennials, sedges, grasses, shrubs and/or trees in a mass bed planting. This template is recommended for commercial sites where visibility is important. This template requires maintenance much like traditional landscape beds.
- ❖ **Meadow.** This is a lower maintenance approach that focuses on the herbaceous layer and may resemble a wildflower meadow or prairie. The goal is to establish a more natural look that may be appropriate if the facility is located in a lower maintenance area (e.g., further from buildings and parking lots). Shrubs and trees may be incorporated. Erosion control matting can be used in lieu of the conventional mulch layer.
- ❖ **Reforestation.** This option plants a variety of tree seedlings and saplings in which the species distribution is modeled on characteristics of existing local forest ecosystems. Trees are planted in groups with the goal of establishing a mature forest canopy. This template is appropriate for large bioretention areas located at wooded edges or where a wooded buffer is desired. **If this template is used, refer directly to Reforestation GIP-10.**

The choice of which planting template to use depends on the scale of bioretention, the context of the site in the urban environment, the filter depth, the desired landscape amenities, and the future owner's capability to maintain the landscape. In general, the vegetative goal is to achieve surface area coverage of at least 75% in the first two years. For a bioretention area to qualify for Level 2 Design, a minimum of one tree must be planted for every 400 square feet.



**6.8.1 Plant Spacing**

Table GIP-01-03 is for use only when plants are spaced equidistant from each other as shown in Figure GIP-01-12, below.

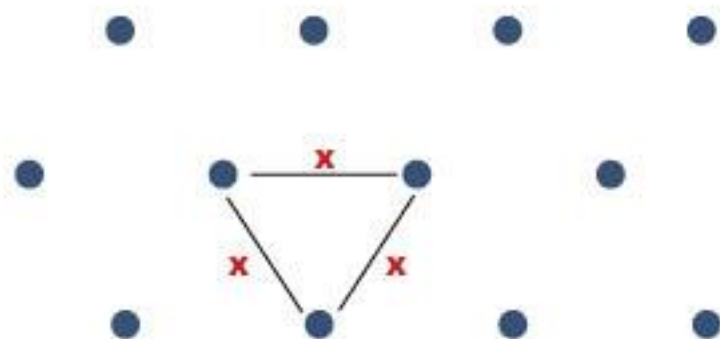


Figure GIP-01-12 Typical plant spacing where x equals distance on center (O.C.) of plant species.

Table GIP-01-03 Plant Spacing for Perennials, Grasses, Sedges and Shrubs	
Spacing (O.C.)	Plants per 100 sq.ft.
18" o.c.	51.2
24" o.c.	29
28" o.c.	22
30" o.c.	18.5
36" o.c.	12.8
42" o.c.	10
4' o.c.	7.23
5' o.c.	4.61
6' o.c.	3.2
8' o.c.	1.8



Table GIP-01-04. Popular Native Perennials for Bioretention – Full Sun

Latin Name	Common Name	Size	Spacing	Moisture	Color	Height
<i>Asclepias incarnate</i>	Marsh milkweed	Plugs – 1 gal.	1 plant/24" o.c.	Wet	Pink	3-4'
<i>Asclepias purpureascens</i>	Purple milkweed	Plugs – 1 gal.	1 plant/18" o.c.	Moist	Purple	3'
<i>Asclepias syriaca</i>	Common milkweed	Plugs – 1 gal.	1 plant/18" o.c.	Moist-dry	Orange	2-5'
<i>Asclepias tuberosa</i>	Butterfly milkweed	Plugs – 1 gal.	1 plant/18" o.c.	Dry-moist	Orange	2'
<i>Asclepias verdis</i>	Green milkweed	Plugs – 1 gal.	1 plant/18" o.c.	Moist	Green	2'
<i>Asclepias verticillata</i>	Whorled milkweed	Plugs – 1 gal.	1 plant/18" o.c.	Moist	White	2.5'
<i>Aster laevis</i>	Smooth aster	Plugs – 1 gal.	1 plant/18" o.c.	Moist	Blue	2-4'
<i>Aster novae-angliae</i>	New England aster	Plugs – 1 gal.	1 plant/24" o.c.	Wet-moist	Blue	2-5'
<i>Aster sericeus</i>	Silky aster	Plugs – 1 gal.	1 plant/18" o.c.	Dry	Purple	1-2'
<i>Chamaecrista fasciculata</i>	Partridge pea	Plugs – 1 gal.	1 plant/18" o.c.	Dry	Yellow	1-2'
<i>Conoclinium coelestinum</i>	Mist flower	Plugs – 1 gal.	1 plant/18" o.c.	Moist-dry	Blue	1-2'
<i>Coreopsis lanceolata</i>	Lance-leaf coreopsis	Plugs – 1 gal.	1 plant/18" o.c.	Moist-dry	Yellow	6-8'
<i>Echinacea pallida</i>	Pale purple coneflower	Plugs – 1 gal.	1 plant/18" o.c.	Dry	Purple	2-3'
<i>Echinacea purpurea</i>	Purple coneflower	Plugs – 1 gal.	1 plant/18" o.c.	Moist-dry	Purple	3-4'
<i>Eupatorium perfoliatum</i>	Boneset	Plugs – 1 gal.	1 plant/24" o.c.	Wet	White	3-5'
<i>Eupatorium purpureum</i>	Sweet Joe-Pye Weed	Plugs – 1 gal.	1 plant/24" o.c.	Wet-moist	Purple	3-6'
<i>Iris virginica</i>	Flag Iris	Plugs – 1 gal.	1 plant/18" o.c.	Moist-Wet	Blue	2'
<i>Liatris aspera</i>	Rough blazingstar	Plugs – 1 gal.	1 plant/18" o.c.	Moist-dry	Purple	2-5'
<i>Liatris microcephala</i>	Small-headed	Plugs – 1 gal.	1 plant/18" o.c.	Moist-dry	Purple	3'
<i>Liatris spicata</i>	Dense blazingstar	Plugs – 1 gal.	1 plant/24" o.c.	Wet-moist	Purple	1.5'
<i>Liatris squarrulosa</i>	Southern blazingstar	Plugs – 1 gal.	1 plant/18" o.c.	Moist-dry	Purple	2-6'
<i>Lobelia cardinalis</i>	Cardinal flower	Plugs – 1 gal.	1 plant/18" o.c.	Wet-moist	Red	2-4'
<i>Monarda didyma</i>	Bee balm	Plugs – 1 gal.	1 plant/24" o.c.	Wet-moist	Red	3'
<i>Monarda fistulosa</i>	Wild bergamot	Plugs – 1 gal.	1 plant/18" o.c.	Moist	Purple	1-3'
<i>Oenothera fruticosa</i>	Sundrops	Plugs – 1 gal.	1 plant/18" o.c.	Moist-dry	Yellow	
<i>Penstemon digitalis</i>	Smooth white	Plugs – 1 gal.	1 plant/24" o.c.	Wet	White	2-3'
<i>Penstemon hirsutus</i>	Hairy beardtongue	Plugs – 1 gal.	1 plant/18" o.c.	Dry	White	1-3'
<i>Penstemon smallii</i>	Beardtongue	Plugs – 1 gal.	1 plant/18" o.c.	Moist	Purple	1-2'
<i>Pycnanthemum tenuifolium</i>	Slender mountain mint	Plugs – 1 gal.	1 plant/18" o.c.	Moist	White	1.5-2.5'
<i>Ratibida pinnata</i>	Gray-headed	Plugs – 1 gal.	1 plant/18" o.c.	Moist	Yellow	2-5'
<i>Rudbeckia hirta</i>	Black-eyed Susan	Plugs – 1 gal.	1 plant/18" o.c.	Moist-dry	Yellow	3'
<i>Salvia lyrata</i>	Lyre-leaf sage	Plugs – 1 gal.	1 plant/18" o.c.	Moist	Purple	1-2'
<i>Solidago nemoralis</i>	Gray goldenrod	Plugs – 1 gal.	1 plant/18" o.c.	Dry	Yellow	2'
<i>Solidago rugosa</i>	Rough-leaved	Plugs – 1 gal.	1 plant/18" o.c.	Wet	Yellow	1-6'
<i>Veronacastrum virginicum</i>	Culver's root	Plugs – 1 gal.	1 plant/24" o.c.	Dry	White	3-6'
<i>Veronia veboracensis</i>	Tall ironweed	Plugs – 1 gal.	1 plant/24" o.c.	Wet-moist	Purple	3-4'

Plant material size and grade to conform to "American Standards for Nursery Stock" American Association of Nurserymen, Inc. latest approved revision, ANSI Z-60-1





Table GIP-01-05. Popular Native Perennials for Bioretention – Shade

Latin Name	Common Name	Size	Spacing	Moisture	Color	Height
<i>Aquilegia canadensis</i>	Wild columbine	Plugs – 1 gal.	1 plant/18" o.c.	Moist-dry	Pink	1-2.5'
<i>Athyrium filix-femina</i>	Lady Fern	1 gal.	1 plant/18" o.c.	Moist	Green	3'
<i>Arisaema triphyllum</i>	Jack-in-the-pulpit	Plugs – 1 gal.	1 plant/18" o.c.	Moist	Green	1.5-2.5'
<i>Arisaema dracunculifolium</i>	Green dragon	Plugs – 1 gal.	1 plant/18" o.c.	Wet-moist	Green	3'
<i>Asarum canadense</i>	Wild ginger	Plugs – 1 gal.	1 plant/18" o.c.	Wet-moist	Red-brown	0.5-1'
<i>Aster cardifolius</i>	Blue wood aster	Plugs – 1 gal.	1 plant/18" o.c.	Moist-dry	Blue	1-3'
<i>Aster novae-angliae</i>	New England aster	Plugs – 1 gal.	1 plant/24" o.c.	Moist-dry	Blue/purple	3-4'
<i>Aster oblongifolius</i>	Aromatic Aster	Plugs – 1 gal.	1 plant/24" o.c.	Moist-dry	Blue/purple	1.5-3'
<i>Coreopsis major</i>	Tickseed coreopsis	Plugs – 1 gal.	1 plant/18" o.c.	Moist-dry	Yellow	3'
<i>Dryopteris marginalis</i>	Shield Fern	1 gal.	1 plant/18" o.c.	Moist	Green	2-3'
<i>Geranium maculatum</i>	Wild geranium	Plugs – 1 gal.	1 plant/18" o.c.	Moist	Pink	2'
<i>Heuchera americana</i>	Alumroot	Plugs – 1 gal.	1 plant/18" o.c.	Moist-dry	Purple	1'
<i>Iris cristata</i>	Dwarf crested iris	Plugs – 1 gal.	1 plant/18" o.c.	Moist-dry	Purple	4"
<i>Lobelia siphilicata</i>	Great blue lobelia	Plugs – 1 gal.	1 plant/18" o.c.	Wet-moist	Blue	1.5-3'
<i>Lobelia cardinalis</i>	Cardinal flower	Plugs – 1 gal.	1 plant/18" o.c.	Wet-moist	Red	2-4'
<i>Mertensia virginica</i>	Virginia bluebells	Plugs – 1 gal.	1 plant/18" o.c.	Moist	Blue	1.5'
<i>Osmunda cinnamomea</i>	Cinnamon Fern	1 gal.	1 plant/24" o.c.	Wet-moist	Green	3-4'
<i>Phlox divaricata</i>	Blue phlox	Plugs – 1 gal.	1 plant/18" o.c.	moist	Blue	0.5-2'
<i>Polemonium reptans</i>	Jacob's ladder	Plugs – 1 gal.	1 plant/18" o.c.	Moist-dry	Blue	15"
<i>Polystichum acrostichoides</i>	Christmas fern	Plugs – 1 gal.	1 plant/24" o.c.	Moist-dry	Evergreen	2'
<i>Stylophoru diphyllum</i>	Wood poppy	Plugs – 1 gal.	1 plant/18" o.c.	Wet -moist	Yellow	1.5'

Plant material size and grade to conform to “American Standards for Nursery Stock” American Association of Nurserymen, Inc. latest approved revision, ANSI Z-60-1.



Table GIP-01-06. Popular Native Grasses and Sedges for Bioretention						
Latin Name	Common Name	Size	Spacing	Moisture	Color	Height
<i>Carex grayi</i>	Gray's Sedge	1 gal.	1 plant/24" o.c.	Moist	Green	3'
<i>Carex muskingumensis</i>	Palm Sedge	1 gal.	1 plant/24" o.c.	Moist	Green	3'
<i>Carex stricta</i>	Tussock Sedge	1 gal.	1 plant/24" o.c.	Moist	Green	3-4'
<i>Chasmanthium latifolium</i>	Upland Sea Oats	Plugs – 1 gal.	1 plant/18" o.c.	Moist-dry	Green	4'
<i>Equisetum hyemale</i>	Horsetail	Plugs – 1 gal.	1 plant/18" o.c.	Wet	Green	3'
<i>Juncus effesus</i>	Soft Rush	Plugs – 1 gal.	1 plant/24" o.c.	Wet-dry	Green	4-6'
<i>Muhlenbergia capallaris</i>	Muhly Grass	1 gal.	1 plant/24" o.c.	Moist	Pink	3'
<i>Panicum virgatum</i>	Switchgrass	1-3 gal.	1 plant/48" o.c.	Moist-dry	Yellow	5-7'
<i>Schizachyrium scoparium</i>	Little Blue Stem	1 gal.	1 plant/24" o.c.	Moist-dry	Yellow	3'
<i>Sporobolus heterolepis</i>	Prairie Dropseed	1 gal.	1 plant/24" o.c.	Moist-dry	Green	2-3'

Plant material size and grade to conform to “American Standards for Nursery Stock” American Association of Nurserymen, Inc. latest approved revision, ANSI Z-60-1.



Table GIP-01-07. Popular Native Trees for Bioretention							
Latin Name	Common Name	DT-FT	Light	Moistur e	Notes	Flower Color	Height
<i>Acer rubrum</i>	Red Maple	DT-FT	Sun-shade	Dry-wet	Fall color		50-70'
<i>Acer saccharum</i>	Sugar Maple		Sun-pt shade	Moist	Fall color		50-75'
<i>Ameleanchier Canadensis</i>	Serviceberry		Sun-pt shade	Moist-wet	Eatable berries	White	15-25'
<i>Asimina triloba</i>	Paw Paw		Sun-pt shade	Moist	Eatable fruits	Maroon	15-30'
<i>Betula nigra</i>	River Birch	FT	Sun-pt shade	Moist-wet	Exfoliating bark		40-70'
<i>Carpinus caroliniana</i>	Ironwood		Sun-pt shade	Moist		White	40-60'
<i>Carya aquatica</i>	Water Hickory	FT-DT	Sun	Moist	Fall color		35-50'
<i>Cercus Canadensis</i>	Redbud	DT	Sun-shade	Moist	Pea-like flowers, seed pods	Purple	20-30'
<i>Chionanthus virginicus</i>	Fringetree		Sun-pt shade	Moist	Paniced, fragrant flowers	White	12-20'
<i>Cladratis lutea</i>	Yellowwood	DT	Sun	Dry-moist	Fall color	White	30-45'
<i>Cornus florida</i>	Flowering Dogwood		Part shade	Moist	Red fruit, wildlife	White	15-30'
<i>Ilex opaca</i>	American Holly	DT	Sun-pt shade	Moist	Evergreen	White	30-50'
<i>Liquidambar styraciflua</i>	Sweetgum	DT-FT	Sun-pt shade	Dry-moist	Spiny fruit		60-100'
<i>Magnolia virginiana</i>	Sweetbay Magnolia		Sun-pt shade	Moist-wet	Evergreen	White	10-60'
<i>Nyssa sylvatica</i>	Black Gum		Sun-Shade	Moist	Fall color		35-50'
<i>Oxydendrum arboretum</i>	Sourwood		Sun-pt shade	Dry-moist	Wildlife	White	20-40'
<i>Platanus occidentalis</i>	Sycamore	FT	Sun-pt shade	Moist	White mottled bark		70-100'
<i>Quercus bicolor</i>	Swamp White Oak	DT	Sun-pt shade	Moist-wet	Acorns		50-60'
<i>Quercus nuttalli</i>	Nuttall Oak	DT	Sun	Dry-moist	Acorns		40-60'
<i>Quercus lyrata</i>	Overcup Oak	FT	Sun	Moist	Acorns		40-60'
<i>Quercus shumardii</i>	Shumard Oak	DT	Sun	Moist	Acorns		40-60'
<i>Rhamnus caroliniana</i>	Carolina Buckthorn		Sun	Moist	Black fruit		15-30'
<i>Salix nigra</i>	Black Willow	FT	Sun-pt shade	Moist-wet	White catkins	Yellow	40-60'
<i>Ulmus americana</i>	American Elm	DT-FT	Sun-pt shade	Moist			
<i>Salix nigra</i>	Black Willow	FT	Pt shade	Moist-	White catkins	Yellow	40-60'

Size: min. 2" caliper if not reforestation.

DT: Drought Tolerant FT: Flood Tolerant





Plant material size and grade to conform to “American Standards for Nursery Stock” American Association of Nurserymen, Inc. latest approved revision, ANSI Z-60-1.

**Table GIP-01-08. Popular Native Shrubs for Bioretention**

Latin Name	Common Name	DT FT	Light	Moisture	Spacing (0 C)	Notes	Flower Color	Height
<i>Aronia arbutifolia</i>	Red Chokeberry	FT	Sun-pt shade	Dry-wet	4'	Red berries, wildlife	White	6-12'
<i>Buddleia davidii</i>	Butterfly Bush	DT	Sun-pt shade	Dry-moist	4'	Non-native	Blue	5'
<i>Callicarpa Americana</i>	American Beautyberry	DT	Sun-pt shade	Dry-wet	5'	Showy purple fruit	Lilac	4-6'
<i>Cephalanthus occidentalis</i>	Button Bush	FT	Sun-shade	Moist-wet	5'	Attracts wildlife	White	6-12'
<i>Clethra alnifolia</i>	Sweet Pepper Bush		Sun-pt shade	Dry-moist	3'	Hummingbird	White	5-8'
<i>Cornus amomum</i>	Silky Dogwood		Sun-shade	Moist-wet	6'	Blue berries, wildlife	White	6-12'
<i>Corylus americana</i>	American Hazelnut		Sun-pt shade	Dry-moist	8'	Eatable nuts, wildlife	Yellow	8-15'
<i>Hamamelis virginiana</i>	Witch-hazel		Sun-pt shade	Dry-moist	8'	Winter bloom	Yellow	10'
<i>Hibiscus moscheutos</i>	Swamp Mallow	FT	Sun	Moist-wet	30"	Cold-hardy	White – red	4-7'
<i>Hydrangea quercifolia</i>	Oakleaf Hydrangea	DT	Pt shade – shade	Moist	4'	Winter texture	White	3-6'
<i>Hypericum frondosum</i>	Golden St. John's Wort	DT	Sun-pt shade	Dry-moist	30"	Semi-evergreen	Yellow	2-3'
<i>Hypericum prolificum</i>	Shrubby St. John's Wort	DT	Sun-pt shade	Dry-moist	3'	Semi-evergreen	Yellow	3'
<i>Ilex decidua (dwarf var.)</i>	Possumhaw Viburnum	DT	Sun-pt shade	Moist	4-6'	Red berries		6-14'
<i>Ilex glabra</i>	Inkberry	DT	Sun-pt shade	Moist-wet	3'	Evergreen		4-8'
<i>Ilex verticillata</i>	Winterberry Holly	FT	Sun-pt shade	Moist-wet	3'	Red berries		10'
<i>Itea virginica</i>	Virginia Sweetspire	DT FT	Sun-shade	Moist-wet	4'	Fall color	White	4-8'
<i>Lindera benzoin</i>	Spicebush	DT	Pt shade – shade	Moist-wet	8'	Butterflies, wildlife	Yellow	6-12'
<i>Viburnum dentatum</i>	Arrowwood Viburnum		Sun-shade	Dry-wet	6'	Wildlife	White	6-8'

Size: minimum 3 gal. container or equivalent.

DT: Drought Tolerant

FT: Flood Tolerant

This list provides plant species; there are multiple varieties within each species.

Plant material size and grade to conform to “American Standards for Nursery Stock” American Association of Nurserymen, Inc. latest approved revision, ANSI Z-60-1.



## 6.9 Bioretention Material Specifications

Table GIP-01-09 outlines the standard material specifications used to construct bioretention areas.

Table GIP-01-09. Bioretention Material Specifications		
Material	Specification	Notes
Filter Media Composition	Filter Media to contain a mix of topsoil, sand and organic matter to achieve the following final composition (by volume): <ul style="list-style-type: none"> <li>• Max 60% sand;</li> <li>• Less than 40% silt</li> <li>• 5% to 10% organic matter; and</li> <li>• Less than 20% CLAY.</li> </ul>	The volume of filter media based on 110% of the plan volume, to account for settling or compaction.
Filter Media Testing	CEC greater than 10 meq/100g	
Mulch Layer	Use mulch meeting requirements specified in Section 6.6.	Lay a 3 inch layer on the surface of the filter bed.
Alternative Surface Cover	Use river stone or pea gravel, coir and jute matting.	Use to suppress weed growth & prevent erosion.
Geotextile/Liner	Use a non-woven geotextile fabric with a flow rate of > 110 gal./min./ft <sup>2</sup> (e.g., Geotex 351 or equivalent)	Apply only to the sides and above the underdrain. For hotspots and certain karst sites only, use an appropriate liner on bottom.
Stone Jacket for Underdrain and/or Storage Layer	12 inch layer of 1 inch stone should be double-washed and clean and free of all fines (e.g., #57 stone).	9 inches of 1 inch stone should cover the underdrain with 3 inches if stone above the top of the pipe; 12 to 18 inches for the stone storage layer (#57 stone), if needed
Underdrains, Cleanouts, and Observation Wells	Use 6 inch corrugated HDPE or PVC pipe with 3/8-inch perforations at 6 inches on center; position each underdrain on a 1% or 2% slope located no more than 20 feet from the next pipe.	Lay the perforated pipe under the length of the bioretention cell, and install nonperforated pipe as needed to connect with the storm drain system. Install T's and Y's as needed, depending on the underdrain configuration. Extend cleanout pipes to the surface with vented caps at the Ts and Ys.
Plant Materials	Shrubs: Minimum 3 gal or 18-24" ht at 4' o.c. (or 1plant/15 s.f.). Grasses, sedges, perennials: Size and max. spacing as called for in Tables 1.4, 1.5 and 1.6 herein. Trees: Minimum size 2" caliper, maximum spacing for Level 2 design of 1 tree/400 s.f. (NOTE: the 2" cal, minimum allows it to be counted toward landscape ordinance requirements)	Establish plant materials as specified in the landscaping plan and the recommended plant list. Alternate plant specification: When using the Forest-type planting template, Reforestation planting densities noted in GIP-10 may be used to meet these plant material specifications.



## GIP – 01 SECTION 7: SPECIAL CASE DESIGN ADAPTATIONS

### 7.1 Shallow Bedrock and Groundwater Connectivity

In settings with shallow bedrock, which can constrain the application of deeper bioretention areas (particularly Level 2 designs); the following design adaptations may be helpful:

- ❖ A linear approach to bioretention, using multiple cells leading to the ditch system, helps conserve hydraulic head.
- ❖ The minimum depth of the filter bed may be 18 to 24 inches. It is useful to limit surface ponding to 6 to 9 inches and avoid the need for additional depth by establishing a turf cover rather than using mulch. The shallower media depth and the turf cover generally comply with the Water Quality Swale specification, and therefore will be credited with a slightly lower pollutant removal (PTP-05 Water Quality Swales).
- ❖ It is important to maintain at least a 0.5% slope in the underdrain to ensure positive drainage.
- ❖ The underdrain should be tied into the ditch or conveyance system.

For more information on bedrock depths download the GIS data set from: <http://water.usgs.gov/GIS/metadata/usgswrd/XML/regolith.xml>.

For more information on soil types go to: <http://websoilsurvey.nrcs.usda.gov/app/>

### 7.2 Steep Terrain

In steep terrain, land with a slope of up to 15% may drain to a bioretention area, as long as a two cell design is used to dissipate erosive energy prior to filtering. The first cell, between the slope and the filter media, functions as a forebay to dissipate energy and settle any sediment that migrates down the slope. Designers may also want to terrace a series of bioretention cells to manage runoff across or down a slope. The drop in slope between cells should be limited to 1 foot and should be armored with river stone or a suitable equivalent.

## GIP - -01 SECTION 8: CONSTRUCTION

### 1.1 Construction Sequence

**Construction Stage Erosion and Sediment Controls.** Small-scale bioretention areas should be fully protected by silt fence or construction fencing, particularly if they will rely on infiltration (i.e., have no underdrains.) Ideally, bioretention should remain outside the limit of disturbance during construction to prevent soil compaction by heavy equipment. Bioretention basin locations may be used as small sediment traps or basins during construction. However, these must be accompanied by notes and graphic details on the erosion prevention and sediment control (EPSC) plan specifying that (1) the maximum excavation depth at the construction stage must be at least 1 foot above the post-construction installation, and (2) the facility must contain an underdrain. The plan must also show the proper procedures for converting the temporary sediment control practice to a permanent bioretention facility, including dewatering, cleanout and stabilization.

### 1.2 Bioretention Installation

The following is a typical construction sequence to properly install a bioretention basin. These steps may be modified to reflect different bioretention applications or expected site conditions:

**Step 1.** Construction of the bioretention area should begin after the entire contributing drainage area has been stabilized with vegetation (See Section 8.1). **THIS IS THE MOST IMPORTANT FACTOR DETERMINING THE SUCCESS OR FAILURE OF THE BIORETENTION AREA. BIORETENTION AREAS WILL FAIL IF SEDIMENT IS ALLOWED**





**TO FLOW INTO THEM.** It may be necessary to block certain curb or other inlets while the bioretention area is being constructed. The proposed site should be checked for existing utilities prior to any excavation.

**Step 2.** The designer and the installer should have a preconstruction meeting, checking the boundaries of the contributing drainage area and the actual inlet elevations to ensure they conform to original design. Since other contractors may be responsible for constructing portions of the site, it is quite common to find subtle differences in site grading, drainage and paving elevations that can produce hydraulically important differences for the proposed bioretention area. The designer should clearly communicate, in writing, any project changes determined during the preconstruction meeting to the installer and the plan review/inspection authority.

**Step 3.** Temporary EPSC controls are needed during construction of the bioretention area to divert stormwater away from the bioretention area until it is completed. Special protection measures such as erosion control fabrics may be needed to protect vulnerable side slopes from erosion during the construction process.

**Step 4.** Any pre-treatment cells should be excavated first and then sealed to trap sediments.

**Step 5.** Excavators or backhoes should work from the sides to excavate the bioretention area to its appropriate design depth and dimensions. Excavating equipment should have scoops with adequate reach so they do not have to sit inside the footprint of the bioretention area. Contractors should use a cell construction approach in larger bioretention basins, whereby the basin is split into 500 to 1,000 sq. ft. temporary cells with a 10-15 foot earth bridge in between, so that cells can be excavated from the side.

**Step 6.** It may be necessary to rip the bottom soils to a depth of 6 to 12 inches to promote greater infiltration.

**Step 7.** Place geotextile fabric on the sides of the bioretention area with a 6-inch overlap on the sides. If a stone storage layer will be used, place the appropriate depth of #57 stone on the bottom, install the perforated underdrain pipe, pack #57 stone to 3 inches above the underdrain pipe, and add approximately 3 inches of choker stone as a filter between the underdrain and the soil media layer. If a stone storage layer is used, the pipe may be placed directly above this layer.

**Step 8.** Deliver or prepare the soil media, and store it on an adjacent impervious area or plastic sheeting. Apply the media in 12-inch lifts until the desired top elevation of the bioretention area is achieved. Wait a few days to check for settlement, and add additional media, as needed, to achieve the design elevation.

**Step 9.** Prepare planting holes for any trees and shrubs, install the vegetation, and water accordingly. Install any temporary irrigation.

**Step 10.** Place the surface cover in both cells (mulch, river stone or turf), depending on the design. If coir or jute matting will be used in lieu of mulch, the matting will need to be installed prior to planting (**Step 9**), and holes or slits will have to be cut in the matting to install the plants.

**Step 11.** Install the plant materials as shown in the landscaping plan, and water them during weeks of no rain for the first two months.

**Step 12.** Conduct the final construction inspection (see **Section 9**). Then log the GPS coordinates for each bioretention facility and submit them to the Program.



### 1.3 Construction Inspection

Use detailed inspection checklists that require sign-offs by qualified individuals at critical stages of construction, to ensure that the contractor's interpretation of the plan is consistent with the designer's intent.

## GIP – 01 SECTION 9: AS-BUILT REQUIREMENTS

After the bioretention area has been constructed, the developer must have an as-built certification of the bioretention area conducted by a registered Professional Engineer. The as-built certification verifies that the BMP was installed as designed and approved.

The following components are vital to ensure that the bioretention area works properly and they must be addressed in the as-built certification:

1. Pretreatment measures must be verified.
2. The proper media and gravel depths were installed per plan. Photographs taken during phases of construction should be included to demonstrate.
3. Surrounding drainage areas must be stabilized to prevent sediment from clogging the filter media.
4. Correct ponding depths and infiltration rates must be verified.
5. The landscape plan must be provided.

A mechanism for overflow for large storm events must be provided.

## GOP – 01 SECTION 10: INSPECTION AND MAINTENANCE

### 10.1 Maintenance Document

Each BMP must have a Hamilton County Water Quality Program Storm Water Management Facilities I&M Agreement submitted for approval and maintained and updated by the BMP owner. The Storm Water Management Facilities I&M Agreement must be completed and submitted to the Program with the Land Disturbance permit application. The Storm Water Management Facilities I&M Agreement is for the use of the BMP owner in performing routine inspections. The developer/owner is responsible for the cost of maintenance and annual inspections. The BMP owner must maintain and update the BMP inspections and maintenance plan.

### 10.2 First Year Maintenance Inspections

Successful establishment of bioretention areas requires that the following tasks be undertaken in the first year following installation:

- ❖ **Initial inspections.** For the first 6 months following construction, the site should be inspected at least twice after storm events that exceed 0.5 inch of rainfall.
- ❖ **Spot Reseeding.** Inspectors should look for bare or eroding areas in the contributing drainage area or around the bioretention area, and make sure they are immediately stabilized with grass cover.
- ❖ **Fertilization.** One-time, spot fertilization may be needed for initial plantings.
- ❖ **Watering.** Depending on rainfall, watering may be necessary once a week during the first 2 months, and then as needed during first growing season (April-October), depending on rainfall.
- ❖ **Remove and replace dead plants.** Since up to 10% of the plant stock may die off in the first year, construction contracts should include a care and replacement warranty to ensure that vegetation is properly established and survives during the first growing season following construction. The typical thresholds below which replacement is required are 85% survival of plant material and 100% survival of trees.

### 10.3 Maintenance Inspections

It is highly recommended that a spring maintenance inspection and cleanup be conducted at each bioretention



area. The following is a list of some of the key maintenance problems to look for:

- ❖ Check to see if 75% to 90% cover (mulch plus vegetative cover) has been achieved in the bed, and measure the depth of the remaining mulch.
- ❖ Check for sediment buildup at curb cuts, gravel diaphragms or pavement edges that prevents flow from getting into the bed, and check for other signs of bypassing.
- ❖ Check for any winter- or salt-killed vegetation, and replace it with hardier species.
- ❖ Note presence of accumulated sand, sediment and trash in the pre-treatment cell or filter beds, and remove it.
- ❖ Inspect bioretention side slopes and grass filter strips for evidence of any rill or gully erosion, and repair it.
- ❖ Check the bioretention bed for evidence of mulch flotation, excessive ponding, dead plants or concentrated flows, and take appropriate remedial action.
- ❖ Check inflow points for clogging, and remove any sediment.
- ❖ Look for any bare soil or sediment sources in the contributing drainage area, and stabilize them immediately.
- ❖ Check for clogged or slow-draining soil media, a crust formed on the top layer, inappropriate soil media, or other causes of insufficient filtering time, and restore proper filtration characteristics.

#### 10.4 Routine and Non-Routine Maintenance Tasks

Maintenance of bioretention areas should be integrated into routine landscape maintenance tasks. If landscaping contractors will be expected to perform maintenance, their contracts should contain specifics on unique bioretention landscaping needs, such as maintaining elevation differences needed for ponding, proper mulching, sediment and trash removal, and limited use of fertilizers and pesticides. A customized maintenance schedule must be prepared for each bioretention facility, since the maintenance tasks will differ depending on the scale of bioretention, the landscaping template chosen, and the type of surface cover. A generalized summary of common maintenance tasks and their frequency is provided in **Table GIP-01-10**.

The most common non-routine maintenance problem involves standing water. If water remains on the surface for more than 48 hours after a storm, adjustments to the grading may be needed or underdrain repairs may be needed. The surface of the filter bed should also be checked for accumulated sediment or a fine crust that builds up after the first several storm events. There are several methods that can be used to rehabilitate the filter (try the easiest things first, as listed below):

- ❖ Open the underdrain observation well or cleanout and pour in water to verify that the underdrains are functioning and not clogged or otherwise in need of repair. The purpose of this check is to see if there is standing water all the way down through the soil. If there is standing water on top, but not in the underdrain, then there is a clogged soil layer. If the underdrain and stand pipe indicates standing water, then the underdrain must be clogged and will need to be snaked.
- ❖ Remove accumulated sediment and till 2 to 3 inches of sand into the upper 8 to 12 inches of soil.
- ❖ Install sand wicks from 3 inches below the surface to the underdrain layer. This reduces the average concentration of fines in the media bed and promotes quicker drawdown times. Sand wicks can be installed by excavating or augering (using a tree auger or similar tool) down to the gravel storage zone to create vertical columns which are then filled with a clean open-graded coarse sand material (ASTM C-33 concrete sand or similar approved sand mix for bioretention media). A sufficient number of wick drains of sufficient dimension should be installed to meet the design dewatering time for the facility.
- ❖ Remove and replace some or all of the soil media.





**Table GIP-01-10. Suggested Annual Maintenance Activities for Bioretention**

Maintenance Tasks	Frequency
Mowing of grass filter strips and bioretention turf cover	At least 4 times a year
Spot weeding, erosion repair, trash removal, and mulch raking	Twice during growing season
Add reinforcement planting to maintain desired vegetation density	As needed
Remove invasive plants using recommended control methods	As needed
Stabilize the contributing drainage area to prevent erosion	As needed
Spring inspection and cleanup	Annually
Supplement mulch to maintain a 3 inch layer	Annually
Prune trees and shrubs	Annually
Remove sediment in pre-treatment cells and inflow points	Once every 2 to 3 years
Replace the mulch layer	Every 3 years

## GIP – 01 SECTION 11: COMMUNITY & ENVIRONMENTAL CONCERNS

### 11.1 Designation of Stormwater Hotspots

Stormwater hotspots are operations or activities that are known to produce higher concentrations of stormwater pollutants and/or have a greater risk for spills, leaks or illicit discharges. **Table GIP-01-11** presents a list of potential land uses or operations that may be designated as a **stormwater hotspot**. It should be noted that the actual hotspot generating area may only occupy a portion of the entire proposed use, and that some “clean” areas (such as rooftops) can be diverted away to another infiltration or runoff reduction practice development proposals should be carefully reviewed to determine if any future operation, on all or part of the site, will be designated as a potential stormwater hotspot. Based on this designation, infiltration may be restricted or prohibited.



**Table GIP-01-11. Potential Stormwater Hotspot and Site Design Responses**

Potential Stormwater Hotspot Operation	Restricted Infiltration	No Infiltration <sup>1</sup>
Facilities w/NPDES Industrial permits	■	■
Public works yard		✓
Ports, shipyards and repair facilities		✓
Railroads/ equipment storage		✓
Auto and metal recyclers/scrap yards		✓
Petroleum storage facilities		✓
Highway maintenance facilities		✓
Wastewater, solid waste and composting facilities		✓
Industrial machinery and equipment	✓	
Trucks and trailers	✓	
Airfields	✓	
Aircraft maintenance areas		✓
Fleet storage areas		✓
Parking lots (40 or more parking spaces)	✓	
Gas stations		✓
Highways (2500 ADT)	✓	
Construction business (paving, heavy equipment storage and maintenance)	✓	
Retail/wholesale vehicle/ equipment dealers	✓	
Convenience stores/fast food restaurants	✓	
Vehicle maintenance facilities		✓
Car washes		✓
Nurseries and garden centers	✓	
Golf courses	✓	

**Note:** For a full list of potential stormwater hotspots. Consult Schueler et al (2004)

**Key:** ■ = depends on facility; ✓ = criterion applies

<sup>1</sup>For some facilities, infiltration practices will be permitted for certain areas such as employee parking and roof drainage.

### 11.2 Other Environmental and Community Issues

The following is a list of several other community and environmental concerns that may also arise when infiltration practices are proposed:

**Nuisance Conditions.** Poorly designed infiltration practices can create potential nuisance problems such as basement flooding, poor yard drainage and standing water. In most cases, these problems can be minimized through proper adherence to the setback, soil testing and pretreatment requirements outlined in this specification.

**Mosquito Risk.** Infiltration practices have some potential to create conditions favorable to mosquito breeding, if they clog and have standing water for extended periods. Proper installation and maintenance of the bioretention area will prevent these conditions from occurring.

**Groundwater Injection Permits.** Groundwater injection permits are required if the infiltration practice is deeper than the longest surface area dimension of the practice (EPA, 2008). Designers should investigate whether or not a proposed infiltration practice is subject to Tennessee groundwater injection well permit requirements.



## GIP – 01 SECTION 12: RIGHT OF WAY CONSIDERATIONS

Bioretention can be used in the right of way and is a preferred practice for constrained right of ways when designed as a series of individual on-line or off-line cells. In these situations, the final design closely resembles that of water quality swales. Stormwater can be conveyed to the bioretention area by sheet flow, curb cuts, or grass channels. See **GIP-02 Urban Bioretention** for additional information.

## GIP – 01 SECTION 13: REFERENCES

Chesapeake Stormwater Network (CSN). 2008. *Technical Bulletin 1: Stormwater Design Guidelines for Karst Terrain in the Chesapeake Bay Watershed*. Version 1.0. Baltimore, MD. Available online at: <http://www.chesapeakestormwater.net/all-things-stormwater/stormwater-guidance-for-karst-terrain-in-the-chesapeake-bay.html>

City of Franklin, Stormwater Management Program, January 2014. *City of Franklin Stormwater Best Management Practices Manual*.

CWP. 2007. *National Pollutant Removal Performance Database, Version 3.0*. Center for Watershed Protection, Ellicott City, MD.

Hirschman, D., L. Woodworth and S. Drescher. 2009. *Technical Report: Stormwater BMPs in Virginia's James River Basin – An Assessment of Field Conditions and Programs*. Center for Watershed Protection. Ellicott City, MD.

Hunt, W.F. III and W.G. Lord. 2006. "Bioretention Performance, Design, Construction, and Maintenance." *North Carolina Cooperative Extension Service Bulletin*. Urban Waterways Series. AG-588-5. North Carolina State University. Raleigh, NC.

Hyland, S. 2005. "Analysis of sinkhole susceptibility and karst distribution in the Northern Shenandoah Valley (Virginia): impacts for LID site suitability models." M.S. Thesis. Virginia Polytechnic Institute and State University. Blacksburg, VA.

Lake County, OH. *Bioretention Guidance Manual*. Available online at: <http://www2.lakecountyohio.org/smd/Forms.htm>

LIDC. 2003. *Bioretention Specification*. The Low Impact Development Center, Inc, Beltsville, MD. Available at: <http://www.lowimpactdevelopment.org/epa03/biospec.htm>.

Maryland Department of the Environment. 2001. *Maryland Stormwater Design Manual*. <http://www.mde.state.md.us/Programs/WaterPrograms/SedimentandStormwater/stormwater/design/index.asp>

Minnesota Stormwater Steering Committee (MSSC). 2005. *The Minnesota Stormwater Manual*. MWS, 2011. *Rain Gardens for Nashville*. Metro Water Services Stormwater NPDES Department, Nashville, TN.

North Shore City. 2007. *Bioretention Design Guidelines*. Sinclair, Knight and Merz. Auckland, New Zealand.

Prince George's Co., MD. *Bioretention Manual*. Available online at:





[http://www.goprincegeorgescounty.com/Government/AgencyIndex/DER/ESD/Bioretenation/bioretenation.asp?nivel=fold men u\(7\)](http://www.goprincegeorgescounty.com/Government/AgencyIndex/DER/ESD/Bioretenation/bioretenation.asp?nivel=fold%20menu(7))

Schueler, T. 2008. Technical Support for the Baywide Runoff Reduction Method. Chesapeake Stormwater Network. Baltimore, MD. [www.chesapeakestormwater.net](http://www.chesapeakestormwater.net)

Schueler et al. 2007. *Urban Stormwater Retrofit Practices*. Manual 3 in the Urban Subwatershed Restoration Manual Series. Center for Watershed Protection. Ellicott City, MD.

State of Virginia BMP Specification No. 8 – Bioretention (2010).

VADCR, 2010. *Stormwater Design Specification No. 9: Bioretention*, version 1.7. Virginia Department of Conservation and Recreation, Richmond, VA.

Wisconsin Department of Natural Resources. *Stormwater Management Technical Standards*.  
<http://www.dnr.state.wi.us/org/water/wm/nps/stormwater/techstds.htm#Post>



## GIP – 01 APPENDIX 1-A INFILTRATION SOIL TESTING PROCEDURES

### I. Test Pit/Boring Procedures

1. The number of required test pits or standard soil borings is based on proposed infiltration area:
  - $< 1,000 \text{ ft}^2 = 2$  tests
  - $1,000 - 10,000 \text{ ft}^2 = 4$  tests
  - $>10,000 \text{ ft}^2 = 4$  tests + 1 test for every additional 5,000  $\text{ft}^2$
2. The location of each test pit or standard soil boring should correspond to the location of the proposed infiltration area.
3. Excavate each test pit or penetrate each standard soil boring to a depth at least 2 feet below the bottom of the proposed infiltration area.
4. If the groundwater table is located within 2 feet of the bottom of the proposed facility, determine the depth to the groundwater table immediately upon excavation and again 24 hours after excavation is completed.
5. Determine the USDA or Unified Soil Classification system textures at the bottom of the proposed infiltration area and at a depth that is 2 feet below the bottom. All soil horizons should be classified and described.
6. If bedrock is located within 2 feet of the bottom of the proposed infiltration area, determine the depth to the bedrock layer.
7. Test pit/soil boring stakes should be left in the field to identify where soil investigations were performed.

### II. Infiltration Testing Procedures

1. The number of required infiltration tests is based on proposed infiltration area:
  - $< 1,000 \text{ ft}^2 = 2$  tests
  - $1,000 - 10,000 \text{ ft}^2 = 4$  tests
  - $>10,000 \text{ ft}^2 = 4$  tests + 1 test for every additional 5,000  $\text{ft}^2$
2. The location of each infiltration test should correspond to the location of the proposed infiltration area.
3. Install a test casing (e.g., a rigid, 4 to 6 inch diameter pipe) to a depth 2 feet below the bottom of the proposed infiltration area.
4. Remove all loose material from the sides of the test casing and any smeared soil material from the bottom of the test casing to provide a natural soil interface into which water may percolate. If desired, a 2-inch layer of coarse sand or fine gravel may be placed at the bottom of the test casing to prevent clogging and scouring of the underlying soils. Fill the test casing with clean water to a depth of 2 feet, and allow the underlying soils to presoak for 24 hours.
5. After 24 hours, refill the test casing with another 2 feet of clean water and measure the drop in water level within the test casing after one hour. Repeat the procedure three (3) additional times by filling the test casing with clean water and measuring the drop in water level after one hour. A total of four (4) observations must be completed. The infiltration rate of the underlying soils may be reported either as the average of all four observations or the value of the last observation. The infiltration rate should be



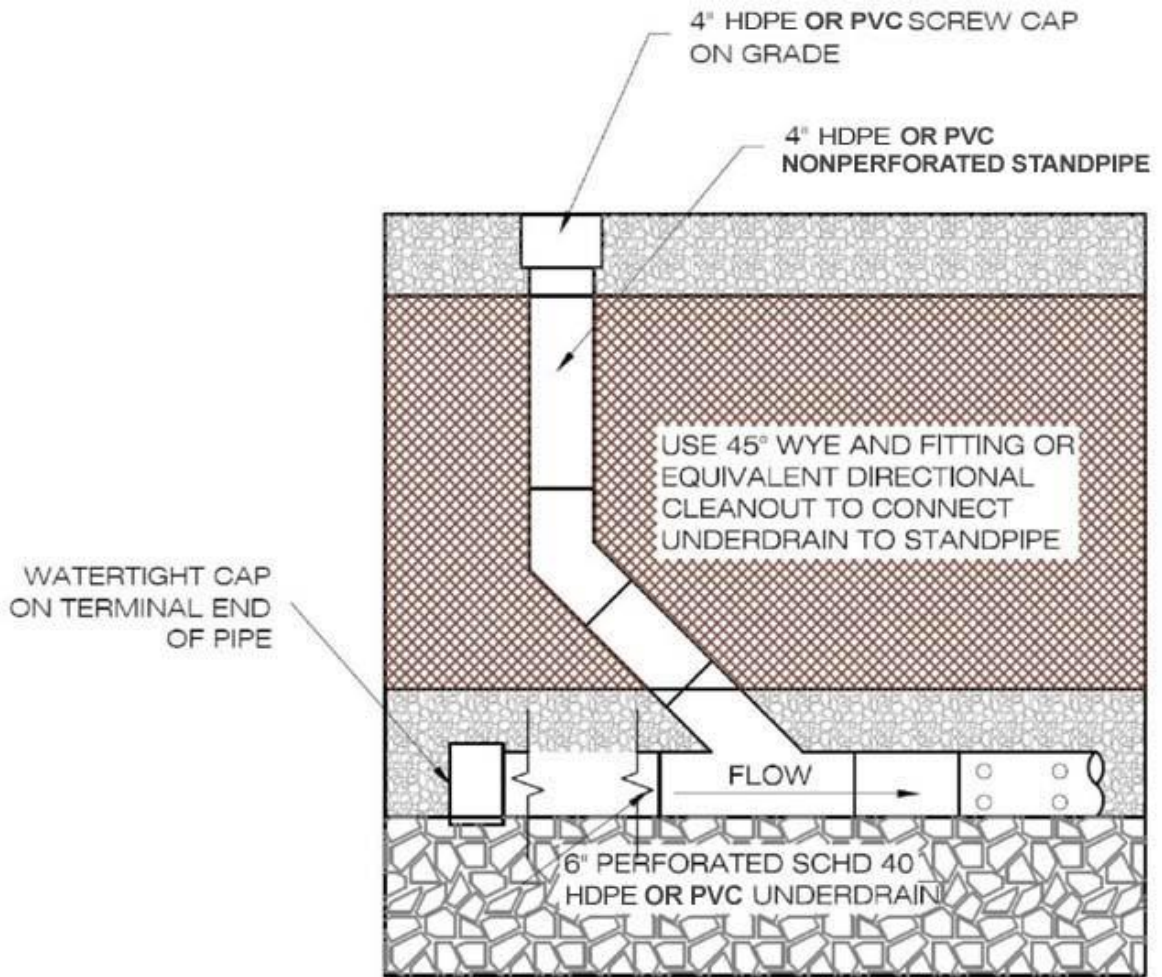
reported in terms of inches per hour.

6. Infiltration testing may be performed within an open test pit or a standard soil boring. After infiltration testing is completed, the test casing should be removed and the test pit or soil boring should be backfilled and restored.

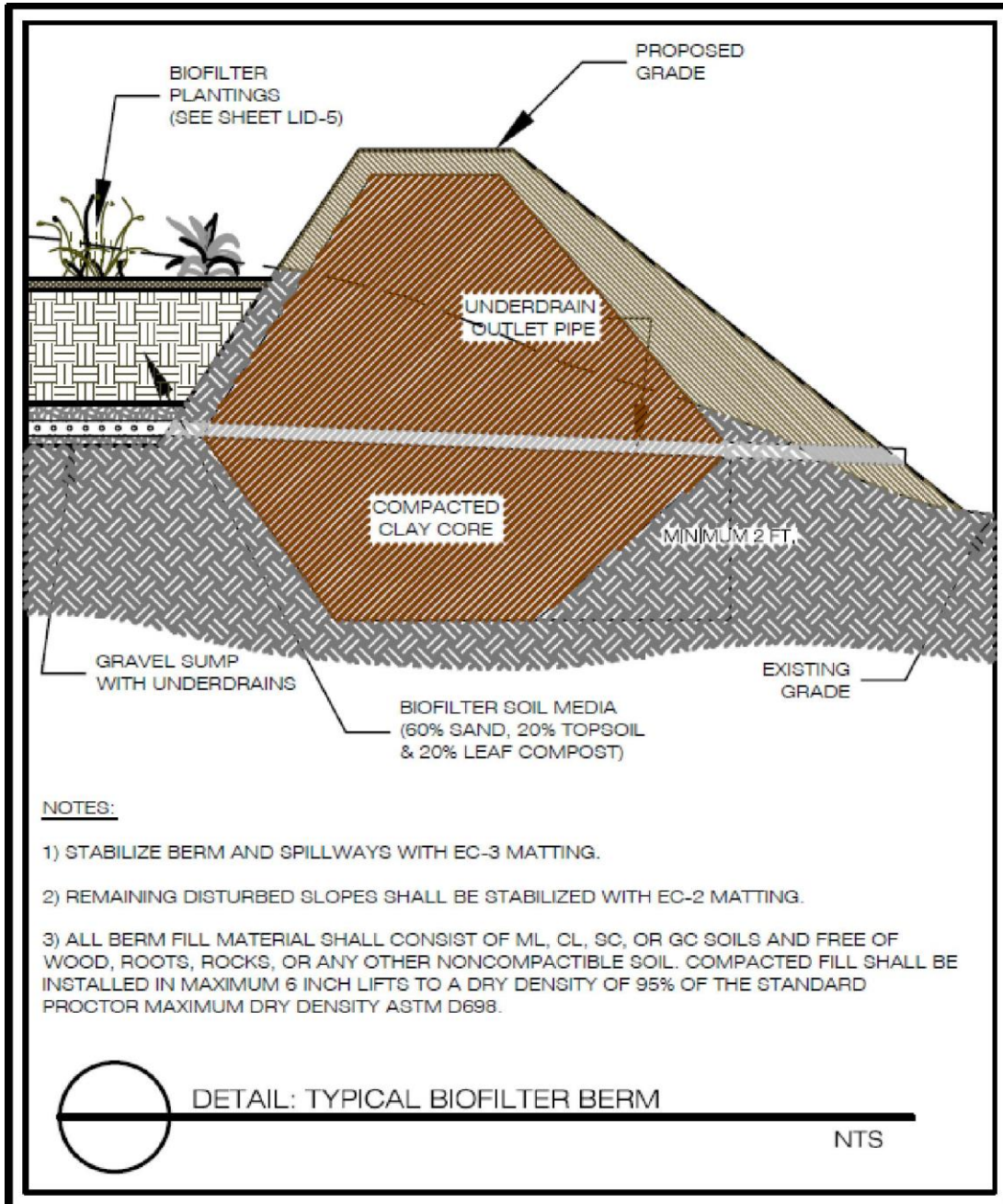




**GIP – 01 APPENDIX 1-B**  
**ADDITIONAL DETAILS AND SCHEMATICS**  
**FOR REGULAR BIORETENTION PRACTICES**

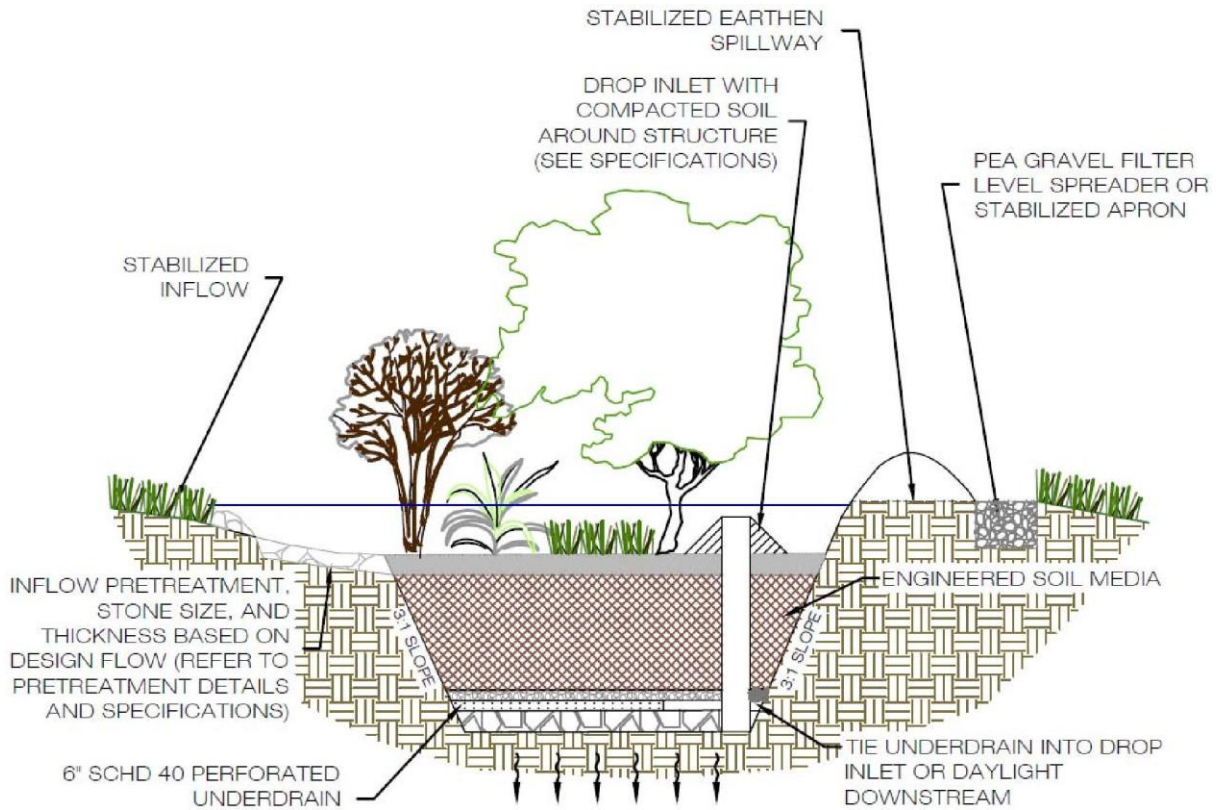


*Figure GIP-01-B1. 1. 4" Cleanout Detail (source: VADCR, 2010)*



**Figure GIP-01-B2. Typical Bioretention Basin Berm (source: VADCR, 2010)**





**Figure GIP-01-B3. Typical Bioretention Basin – Inflow & Outflow – Section**  
(source: VADCR, 2010)





## Urban Bioretention



## GIP - 02

### Hamilton County



### Water Quality Program

**Description:** Urban Bioretention is similar to traditional bioretention practices, except that the bioretention is fit into concrete-sided containers within urban landscapes, such as planter boxes or tree planters. Captured runoff is treated by filtration through an engineered soil medium, and is then either infiltrated into the subsoil or exfiltrated through an underdrain. Variations include planters, green street swales, and planting cells.

#### Advantages/Benefits:

- Reduced runoff volume & peak discharge rate
- Reduced TSS & pollutant loading
- Reduced runoff temperature & heat island effect
- Groundwater recharge (if soils are sufficiently permeable)
- Habitat creation
- Enhanced site aesthetics

#### Disadvantages/Limitations:

- Minimum 2 foot separation from groundwater is required
- Not suitable for pollution hotspots

#### Design considerations:

- Maximum contributing drainage area of 2,500 square feet
- Min infiltration rate > 0.5 inches per hour in order to remove the underdrain requirement
- Design to drain within 24 hours
- Maximum running slope of 3%

#### Right of Way Applications

- Used along curbside in urban areas
- Stormwater can be conveyed by sheet flow or curb cuts
- Pretreatment is especially important in roadway applications where sediment loads may be high
- Design as a series of cells running parallel to roadway
- Impermeable liner must be installed roadside to protect subgrade. Underdrain required

#### Selection Criteria:

**LEVEL 1 – 60% Runoff Reduction Credit**

#### Land Use Considerations:

- Residential
- Commercial
- Industrial (with Approval)

#### Maintenance:

- Regular maintenance of landscaping to maintain healthy vegetative cover
- Irrigation when necessary during first growing season
- Periodic trash removal

#### Maintenance Burden

L = Low  M = Moderate  H = High



## GIP – 02 SECTION 1: DESCRIPTION

Urban bioretention practices are similar in function to regular bioretention practices except they are adapted to fit into “containers” within urban landscapes. Typically, urban bioretention is installed within an urban streetscape or street Right of Way (ROW), urban landscaping beds, tree planters, and plazas. Urban bioretention is not intended for large commercial areas, nor should it be used to treat small sub-areas of a large drainage area such as a parking lot. Rather, urban bioretention is intended to be incorporated into small fragmented drainage areas such as shopping or pedestrian plazas within a larger urban development. Urban Bioretention within the ROW can only be used to treat water that falls in the ROW.

Urban bioretention features hard edges, often with vertical concrete sides, as contrasted with the more gentle earthen slopes of regular bioretention. If these practices are outside of the ROW, they may be open-bottomed, to allow some infiltration of runoff into the sub-grade, but they generally are served by an underdrain.

**Stormwater planters** (also known as vegetative box filters or foundation planters) take advantage of limited space available for stormwater treatment by placing a soil filter in a container located above ground or at grade in landscaping areas between buildings and roadways with liner protection (**Figure GIP-02-01**). The small footprint of foundation planters is typically contained in a precast or cast-in-place concrete vault. Other materials may include molded polypropylene cells and precast modular block systems. Stormwater planters must be outside the ROW if they are treating roof water or runoff from areas outside of the ROW.



**Figure GIP-02-01. Stormwater Planters (source: City of Portland, OR)**

**Green Street swales and planters** are installed in the sidewalk zone near the street where urban street trees are normally installed. The soil volume for the tree pit is increased and used as a stormwater storage area (**Figure GIP-02-02**). Treatment is increased by using a series of connected tree planting areas together in a row. The surface of the enlarged planting area may be mulch, grates or pervious pavement (if outside the ROW). Large and shared rooting space and a reliable water supply increase the growth and survival rates in this otherwise harsh planting environment.





**Figure GIP-02-02. Green Street Planters on Deaderick St., Nashville, TN**

Each urban bioretention variant is planted with a mix of trees, shrubs, and grasses as appropriate for its size and landscaping context.

## GIP – 02 SECTION 2: PERFORMANCE

The runoff reduction function of an urban bioretention area is described in **Table GIP-02-01**.

Table GIP-02-01. Runoff Volume Reduction Provided by Urban Bioretention Areas		
Stormwater Function	Level 1 Design	Level 2 Design
Runoff Volume Reduction (RR)	60%	Level 1 Design Only

Sources: CSN (2008) and CWP (2007)





## GIP – 02 SECTION 3: DESIGN TABLE

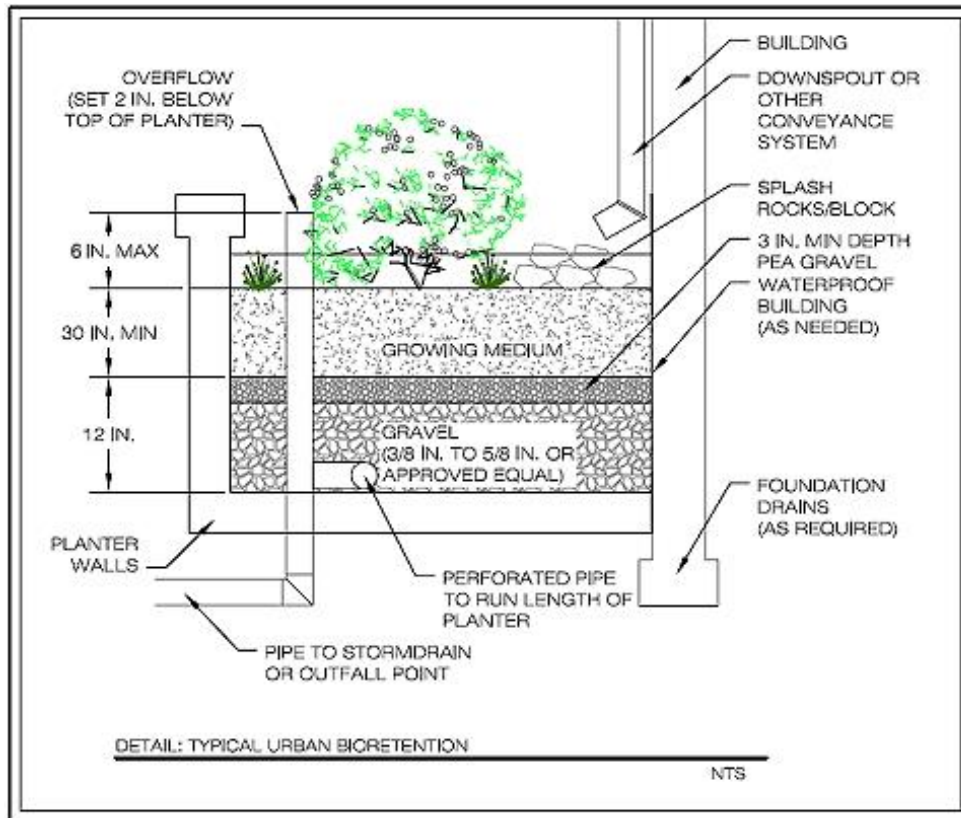
Design criteria for urban bioretention are detailed in **Table GIP-02-02**, below.

Table GIP-02-02. Urban Bioretention Design Criteria
<b>Level 1 Design Only (RR: 60)</b>
Sizing (Refer to <b>Section 6.1</b> ): Surface Area (sq. ft.) = $Tv/\text{Storage Depth}^1 = \{(1.0 \text{ inch})(Rv)(A)/12 - \text{the volume reduced by an upstream BMP}\}/\text{Storage Depth}^1$
Underdrain = PVC or HDPE with clean-outs (Refer to the <b>Main Bioretention Design Specification GIP-01, Section 6.7</b> )
Maximum Drainage Area = 2,500 sq. ft.
Maximum Ponding Depth = 6 inches
Filter media depth minimum = 30 inches; recommended maximum = 48 inches
Gravel layer depth minimum = 6 inches
Media and Surface Cover (Refer to <b>GIP-01, Section 6.6</b> )
Sub-soil testing (Refer to <b>GIP-01, Section 6.2</b> )
Inflow = sheet flow, curb cuts, trench drains, roof drains, concentrated flow, or equivalent
Building setbacks (Refer to <b>Section 5</b> )
Deeded maintenance I&M plan (Refer to <b>GIP-01, Section 9</b> )

<sup>1</sup> Storage depth is the sum of the porosity ( $n_r$ ) of the soil media and gravel layers multiplied by their respective depths, plus the surface ponding depth. Refer to GIP-02 **Section 6.1**.



## GIP – 02 SECTION 4: TYPICAL DETAILS



**Figure GIP-02-04. Stormwater Planter Cross-Section (source: VADCR, 2010)**

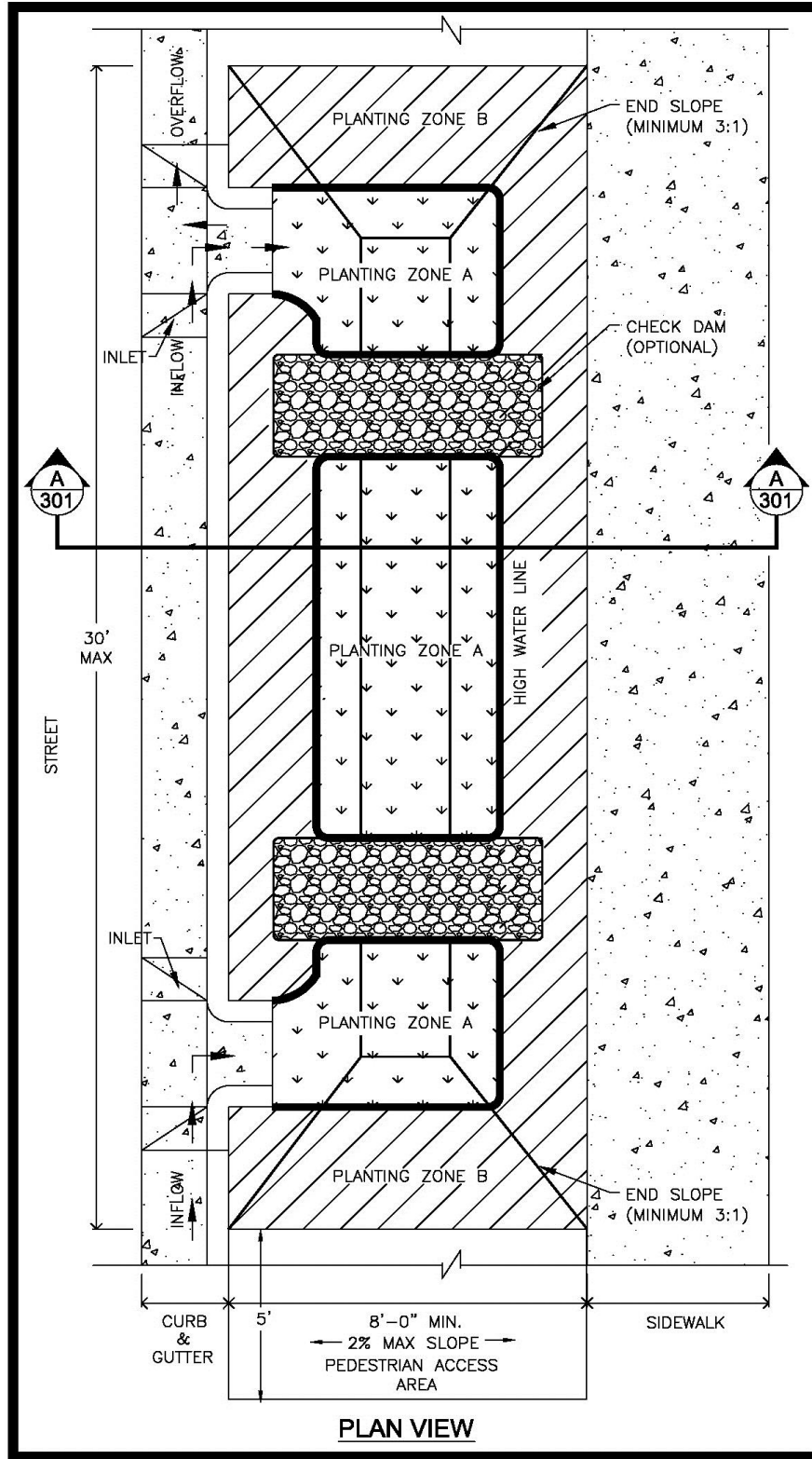
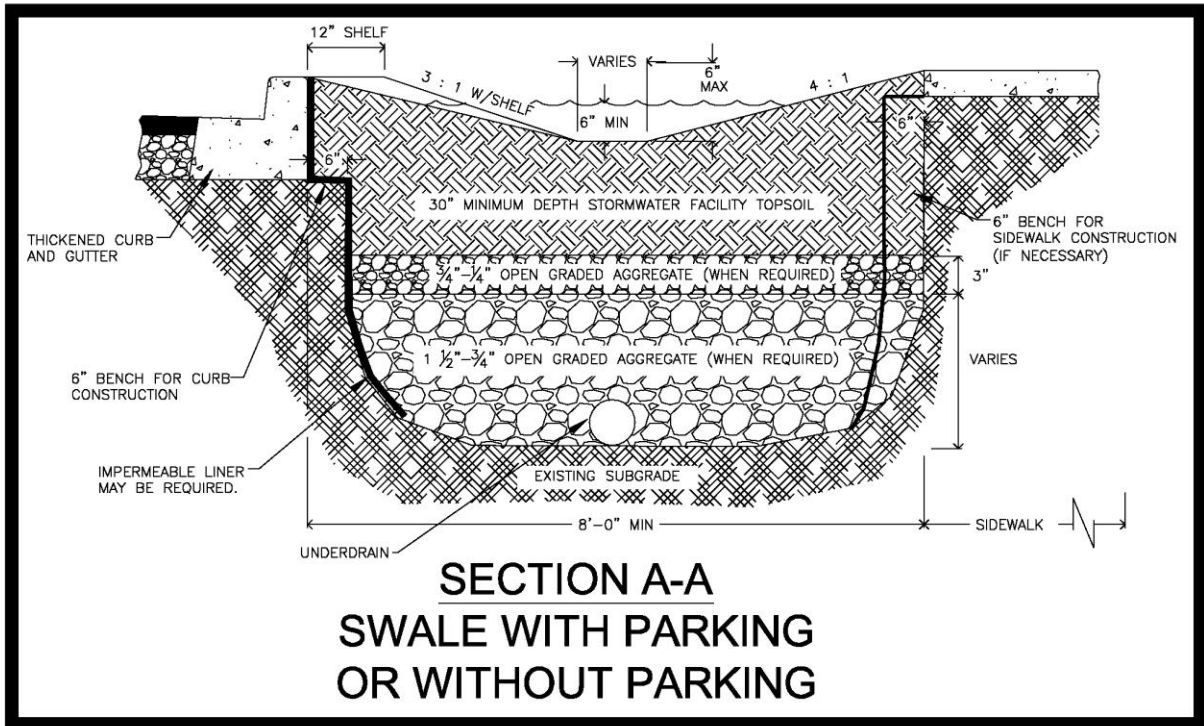


Figure GIP-02-05. Green Streets Swale Plan View (source: Portland, 2011)





*Figure GIP-02-06. Green Streets Swale Section View (source: Portland, 2011)*



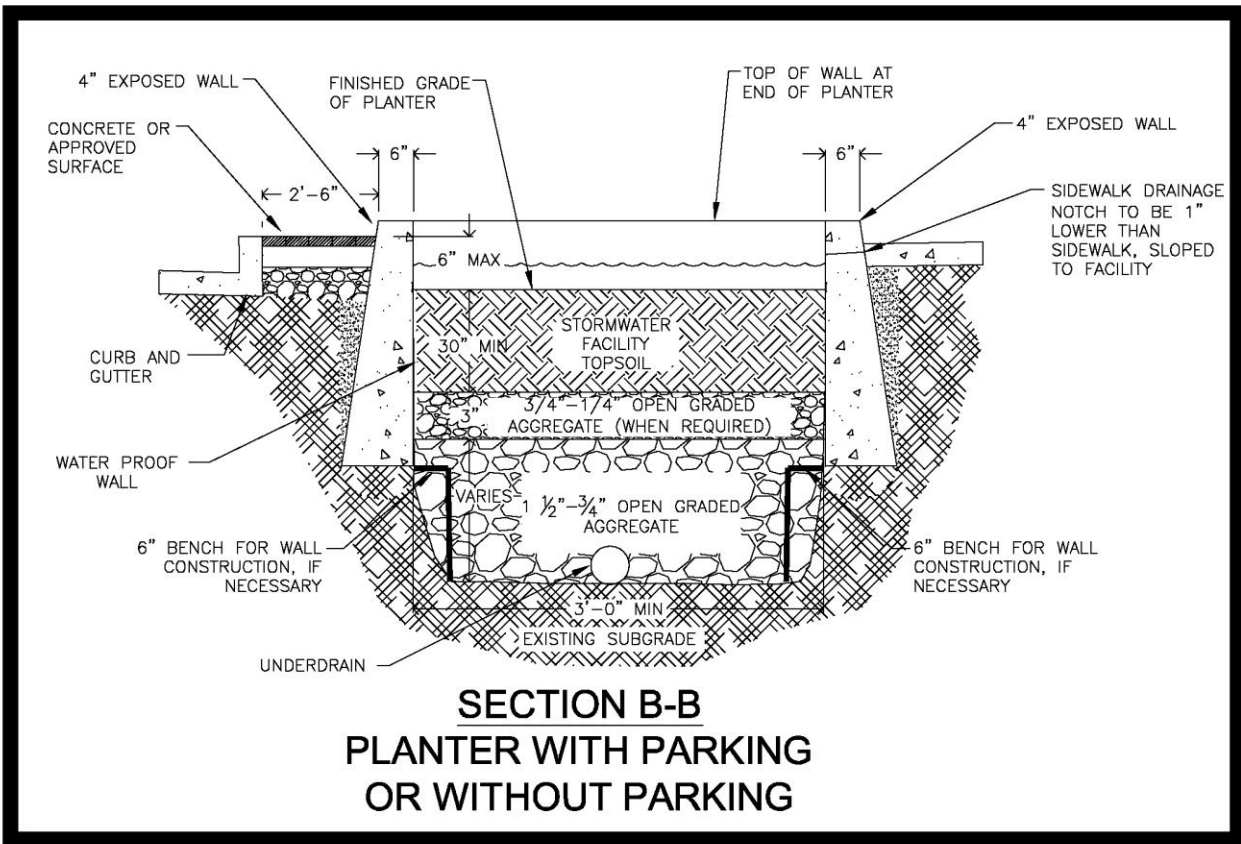


Figure GIP-02-08. Green Streets Planter Section View With or Without Parking (source: Portland, 2011)

## GIP – 02 SECTION 5: PHYSICAL FEASIBILITY & DESIGN APPLICATIONS

In general, urban bioretention has the same constraints as regular bioretention, along with a few additional constraints as noted below:

**Contributing Drainage Area.** Urban bioretention is limited to 2,500 sq. ft. of drainage area. However, this is considered a general rule; larger drainage areas may be allowed with sufficient flow controls and other mechanisms to ensure proper function, safety, and community acceptance. The drainage areas in these urban settings are typically considered to be 100% impervious. While multiple planters or swales can be installed to maximize the treatment area in ultra-urban watersheds, urban bioretention is not intended to be used as treatment for large impervious areas (such as parking lots).





**Adequate Drainage.** Urban bioretention practice elevations must allow the untreated stormwater runoff to be discharged at the surface of the filter bed and ultimately connect to the local storm drain system.

**Available Hydraulic Head.** In general, 3 feet of elevation difference is needed between the downstream storm drain invert and the inflow point of the urban bioretention practice. This is generally not a constraint, due to the standard depth of most storm drains systems.

**Setbacks from Buildings and Roads.** If an impermeable liner and an underdrain are used, no setback is needed from the building. Otherwise, the urban bioretention practice should be 10 feet down gradient from the building.

**Proximity to Underground Utilities.** Urban bioretention practices frequently compete for space with a variety of utilities. Since they are often located parallel to the ROW, care should be taken to provide utility-specific horizontal and vertical setbacks. However, conflicts with water and sewer laterals (e.g., house connections) may be unavoidable, and the construction sequence must be altered, as necessary, to avoid impacts to existing service.

**Overhead Wires.** Designers should also check whether future tree canopy heights achieved in conjunction with urban bioretention practices will interfere with existing overhead telephone, cable communications and power lines.

**Minimizing External Impacts.** Because urban bioretention practices are installed in highly urban settings, individual units may be subject to higher public visibility, greater trash loads, pedestrian use traffic, vandalism, and even vehicular loads. These practices should be designed in ways that prevent, or at least minimize, such impacts. In addition, designers should clearly recognize the need to perform frequent landscaping maintenance to remove trash, check for clogging, and maintain vigorous vegetation. The urban landscape context may feature naturalized landscaping or a more formal design. When urban bioretention is used in sidewalk areas of high foot traffic, designers should not impede pedestrian movement or create a safety hazard and maintain the American with Disabilities Act (ADA) required path of travel. Designers may also install low fences (such as a low garden fence), grates or other measures to prevent damage from pedestrian short-cutting across the practices.

## GIP – 02 SECTION 6: DESIGN CRITERIA

Urban bioretention practices are similar in function to regular bioretention practices except they are adapted to fit into “containers” within urban landscapes. Therefore, special sizing accommodations are made to allow these practices to fit in very constrained areas where other surface practices may not be feasible.

### 6.1 Sizing of Urban Bioretention

The required surface area of the urban bioretention filter is calculated by dividing the Treatment Volume by the Equivalent Storage Depth (Equation 2.2 below), in the same manner as it is calculated for traditional bioretention. The equivalent storage depth is computed as the depth of media, gravel, or surface ponding (in feet) multiplied by the accepted void ratio.



The accepted porosities (n) are:

Bioretention Soil Media (GIP-01)	n = 0.40 (sandy loam, loamy sand, or loam)
Gravel	n = 0.40
Surface Storage	n = 1.0

**Equation GIP-02-01. Urban Bioretention Equivalent Storage Depth**

$$\text{Equivalent Storage Depth} = D_E = n_1(D_1) + n_2(D_2) + \dots$$

The equivalent storage depth for an urban bioretention facility with a 6-inch surface ponding depth, a 30-inch media depth, and a 12-inch gravel layer is therefore computed as:

$$D_E = (2.5 \text{ ft.} \times 0.40) + (1 \text{ ft.} \times 0.40) + (0.5 \text{ ft.} \times 1.0) = 1.9 \text{ ft.}$$

Where  $n_1$  and  $D_1$  are for the first layer, etc.

Surface Area (SA) is computed as:

**Equation GIP-02-02. Urban Bioretention Sizing**

$$SA \text{ (sq. ft.)} = T_v \text{ (cu. ft.)} / D_E$$

Where:

- SA = the surface area of the urban bioretention facility (in square feet)
- $D_E$  = Equivalent Storage Depth (ft.)
- $T_v$  = the required Treatment Volume (in cubic feet)

**Equation GIP-02-03. Treatment Volume**

$$T_v = [(1.0 \text{ inch})(R_v)(A)/12]$$

Where:

- $T_v$  = the required Treatment Volume (in cubic feet)
- A = the contributing drainage area (in sq. ft.)
- $R_v$  = Runoff Coefficient found in Section 2.3.3 of this manual

Equations GIP-02-01 and GIP-02-02 should be modified if the storage depths of the soil media, gravel layer, or ponded water vary in the actual design.

**6.2 General Design Criteria for Urban Bioretention**

Design of urban bioretention should follow the general guidance presented in this Bioretention design specification. The actual geometric design of urban bioretention is usually dictated by other landscape elements such as buildings, sidewalk widths, utility corridors, retaining walls, etc. Designers can divert fractions of the runoff volume from small impervious surfaces into urban bioretention that is integrated with the overall landscape design. Inlets and outlets should be located as far apart as possible. The following is additional design guidance that applies to all variations of urban bioretention:



- ❖ The ground surface of the micro-bioretention cell should slope 1% towards the outlet, unless a stormwater planter is used.
- ❖ The soil media depth should be a minimum of 30 inches.
- ❖ If large trees and shrubs are to be installed, soil media depths should accommodate.
- ❖ All urban bioretention practices should be designed to fully drain within 24 hours.
- ❖ Any grates used above urban bioretention areas must be removable to allow maintenance access and must be ADA compliant.
- ❖ The inlet(s) to urban bioretention should be stabilized using coarse aggregate stone, splash block, river stone or other acceptable energy dissipation measures. The following forms of inlet stabilization are recommended:
  - Stone energy dissipaters.
  - Sheet flow over a depressed curb with a 3-inch drop.
  - Curb cuts allowing runoff into the bioretention area.
  - Covered drains that convey flows under sidewalks from the curb or from downspouts (if the bioretention area is outside of the ROW).
  - Grates or trench drains that capture runoff from the sidewalk or plaza area.
- ❖ Pre-treatment options overlap with those of regular bioretention practices. However, the materials used may be chosen based on their aesthetic qualities in addition to their functional properties. For example, river rock may be used in lieu of rip rap. Other pretreatment options may include one of the following:
  - A trash rack between the pre-treatment cell and the main filter bed. This will allow trash to be collected from one location.
  - A trash rack across curb cuts. While this trash rack may clog occasionally, it keeps trash in the gutter, where it can be picked up by street sweeping equipment.
  - A pre-treatment area above ground or a manhole or grate directly over the pre-treatment area.
- ❖ Overflows can either be diverted from entering the bioretention cell or dealt with via an overflow inlet. Optional methods include the following:
  - Size curb openings to capture only the Treatment Volume and bypass higher flows through the existing gutter.
  - Use landscaping type inlets or standpipes with trash guards as overflow devices.
  - Use a pre-treatment chamber with a weir design that limits flow to the filter bed area.

### 6.3 Specific Design Issues for Stormwater Planters

Since stormwater planters are often located near building foundations, waterproofing by using a watertight concrete shell or an impermeable liner is required to prevent seepage.

### 6.4 Specific Design Issues for Green Streets Swales and Planters

- ❖ The bottom of the soil layer must be a minimum of 4 inches below the root ball of plants to be installed.
- ❖ Green streets designs sometimes cover portions of the filter media with pervious pavers (if outside the ROW) or cantilevered sidewalks. In these situations, it is important that the filter media is connected beneath the surface so that stormwater and tree roots can share this space.
- ❖ Installing a tree pit grate over filter bed media is one possible solution to prevent pedestrian traffic and trash accumulation.
- ❖ Low, wrought iron fences can help restrict pedestrian traffic across the tree pit bed and serve as a protective barrier if there is a drop-off from the pavement to the micro-bioretention cell.





- ❖ A removable grate capable of supporting typical H-20 axle loads may be used to allow the tree to grow through it.
- ❖ Each tree needs a minimum of 100 square feet of shared root space.
- ❖ Proprietary tree pit devices are acceptable, provided they conform to this specification.

### 6.5 Planting and Landscaping Considerations

The degree of landscape maintenance that can be provided will determine some of the planting choices for urban bioretention areas. The planting cells can be formal gardens or naturalized landscapes. Landscaping in the ROW should be designed to limit visual obstructions for pedestrian and vehicular traffic.

In areas where less maintenance will be provided and where trash accumulation in shrubbery or herbaceous plants is a concern, consider a “turf and trees” landscaping model. Spaces for herbaceous flowering plants can be included. This may be attractive at a community entrance location.

Native trees or shrubs are preferred for urban bioretention areas, although some ornamental species may be used. As with regular bioretention, selected perennials, shrubs, and trees must be tolerant of drought, and inundation. The landscape designer should also take into account that de-icing materials may accumulate in the bioretention areas in winter and could kill vegetation. Additionally, tree species selected should be those that are known to survive well in the compacted soils and polluted air and water of an urban landscape.

## GIP – 02 SECTION 7: MATERIAL SPECIFICATIONS

Please consult the **main bioretention design specification (GIP-01, Table GIP-01-09)** for the typical materials needed for filter media, stone, mulch, and other bioretention features. In urban planters, pea gravel or river stone may be a more appropriate and attractive mulch than shredded hardwood.

The unique components for urban bioretention may include the inlet control device, a concrete box or other containing shell, protective grates, and an underdrain that daylights to another stormwater practice or connects to the storm drain system. The underdrain should:

- ❖ Consist of slotted pipe greater than or equal to 4 inches in diameter, placed in a layer of washed (less than 1% passing a #200 sieve) crushed stone.
- ❖ Have a minimum of 2 inches of gravel laid above and below the pipe.
- ❖ Be laid at a minimum slope of 0.5 %.
- ❖ Extend the length of the box filter from one wall to within 6 inches of the opposite wall, and may be either centered in the box or offset to one side.
- ❖ Be separated from the soil media by non-woven, geotextile fabric or a 2 to 3 inch layer of 1/8 to 3/8 inch pea gravel.

## GIP – 02 SECTION 8: CONSTRUCTION

The construction sequence and inspection requirements for urban bioretention are generally the same as other bioretention practices. Consult the construction sequence and inspection guidance provided in **the main bioretention design specification (GIP-01)**. In cases where urban bioretention is constructed in the road or ROW, the construction sequence may need to be adjusted to account for traffic control, pedestrian access and utility



notification.

Urban bioretention areas should only be constructed after the drainage area to the facility is completely stabilized. The specified growth media should be placed and spread by hand with minimal compaction, in order to avoid compaction and maintain the porosity of the media. The media should be placed in 12 inch lifts with no machinery allowed directly on the media during or after construction. The media should be overfilled above the proposed surface elevation, as needed, to allow for natural settling. Lifts may be lightly watered to encourage settling. After the final lift is placed, the media should be raked (to level it), saturated, and allowed to settle prior to installation of plant materials.

## GIP – 02 SECTION 9: AS-BUILT REQUIREMENTS

After urban bioretention has been constructed, the developer must have an as-built certification conducted by a registered Professional Engineer. The as-built certification verifies that the BMP was installed as designed and approved. The following components are vital to ensure that the bioretention area works properly and they must be addressed in the as-built certification:

1. The proper media and gravel depths were installed per plan. Photographs taken during phases of construction should be included to demonstrate.
2. Surrounding drainage areas must be stabilized to prevent sediment from clogging the filter media.
3. Correct ponding depths and infiltration rates must be verified.
4. Landscape plan must be provided.

## GIP – 02 SECTION 10: INSPECTION AND MAINTENANCE

Each BMP must have a Hamilton County Water Quality Program Storm Water Management Facilities I&M Agreement submitted for approval and maintained and updated by the BMP owner. The Storm Water Management Facilities I&M Agreement must be completed and submitted to the Program with the Land Disturbance permit application. The Storm Water Management Facilities I&M Agreement is for the use of the BMP owner in performing routine inspections. The developer/owner is responsible for the cost of maintenance and annual inspections. The BMP owner must maintain and update the BMP inspections and maintenance plan.

Routine inspection and maintenance are essential to gain public acceptance of highly visible urban bioretention areas. Weeding, pruning, the removal and replacement of dead vegetation and trash removal should be done as needed to maintain the aesthetics necessary for community acceptance. During drought conditions, it may be necessary to water the plants, as would be necessary for any landscaped area.

To ensure proper performance, installers should check that stormwater infiltrates properly into the soil within 24 hours after a storm. If excessive surface ponding is observed, corrective measures include inspection for soil compaction and underdrain clogging. Consult the maintenance guidance outlined in **the main bioretention design specification (GIP-01)**.

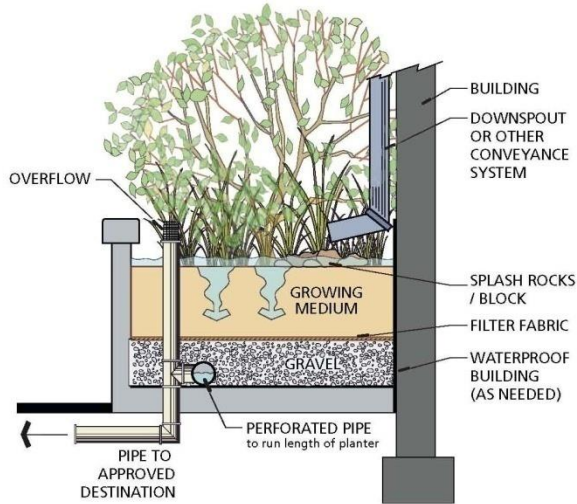
## GIP – 02 SECTION 11: RIGHT OF WAY DESIGN CONSIDERATIONS

Green Street swales and planters are applicable along roads. They can be used along curbside in urban areas with stormwater being conveyed by sheet flow or curb cuts. Green Street swales and planters can also be designed as

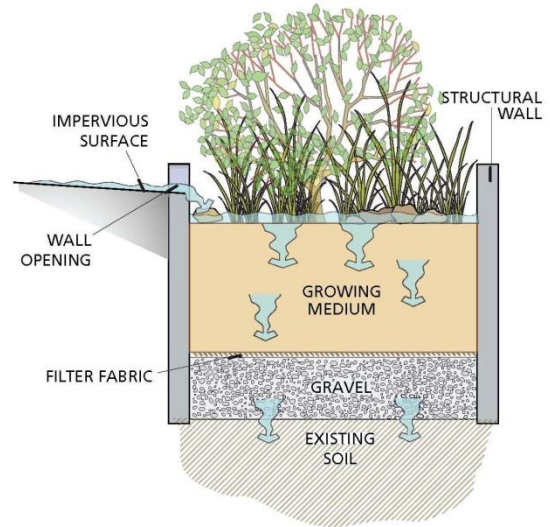




a series of cells running parallel to roadway. An impermeable liner must separate the road subgrade from the bioretention feature.



**Figure GIP-02-06 Flow-through planter.**  
 (Source: Portland Bureau of Environmental Services)



**Figure GIP-02-07 Infiltration planter (Not for ROW).**  
 (Source: Portland Bureau of Environmental Services)



**Figure GIP-02-08 Portland State University street planters.**  
 (Photo: Martina Keefe)



**Figure GIP-02-09 Deaderick Street planters.**





## GIP – 02 SECTION 12: REFERENCES

- Chesapeake Stormwater Network (CSN). 2008. *Technical Bulletin 1: Stormwater Design Guidelines for Karst Terrain in the Chesapeake Bay Watershed*. Version 1.0. Baltimore, MD. Available online at: <http://www.chesapeakestormwater.net/all-things-stormwater/stormwater-guidance-for-karst-terrain-in-the-chesapeake-bay.html>
- CWP. 2007. *National Pollutant Removal Performance Database, Version 3.0*. Center for Watershed Protection, Ellicott City, MD.
- Center for Watershed Protection. 2006. *Urban Watershed Forestry Manual. Part 2: Conserving and Planting Trees at Development Sites*. Ellicott City, MD. Available online at: <http://www.cwp.org/forestry/index.htm>
- City of Franklin Stormwater Best Management Practices Manual*, City of Franklin, Stormwater Management Program, January 2014.
- City of Portland. Bureau of Environmental Services. (Portland BES). 2004. *Portland Stormwater Management Manual*. Portland, OR. <http://www.portlandonline.com/bes/index.cfm?c=dfbcc>
- City of Portland. Bureau of Environmental Services. (Portland BES). 2011. *Stormwater Management Manual Typical Details*. Portland, OR. <http://www.portlandonline.com/bes/index.cfm?c=47963>
- Credit Valley Conservation. 2008. *Credit River Stormwater Management Manual*. Mississauga, Ontario.
- Northern Virginia Regional Commission. 2007. *Low Impact Development Supplement to the Northern Virginia BMP Handbook*. Fairfax, Virginia
- Saxton, K.E., W.J. Rawls, J.S. Romberger, and R.I. Papendick. 1986. "Estimating generalized soil-water characteristics from texture." *Soil Sci. Soc. Am. J.* 50(4):1031-1036.
- Schueler, T., D. Hirschman, M. Novotney and J. Zielinski. 2007. *Urban stormwater retrofit practices*. Manual 3 in the Urban Subwatershed Restoration Manual Series. Center for Watershed Protection, Ellicott City, MD.
- VADCR. 2010. *Stormwater Design Specification No. 9, Appendix 9-A: Urban Bioretention / Stormwater Planters / Expanded Tree Planters / Stormwater Curb Extensions*, version 1.7, March 8, 2010. Virginia Department of Conservation and Recreation.



## GIP-02 APPENDIX A

### Popular Plants Suitable for Tree Planters in Hamilton County

Table GIP-02-03. Popular Native Perennials Suitable for Tree Planters – Full Sun						
Latin Name	Common Name	Size	Spacing	Moisture	Color	Height
<i>Asclepias tuberosa</i>	Butterfly milkweed	Plugs – 1 gal.	1 plant/18” o.c.	Dry-moist	Orange	2’
<i>Aster novae-angliae</i>	New England aster	Plugs – 1 gal.	1 plant/24” o.c.	Wet-moist	Blue	2-5’
<i>Coreopsis lanceolata</i>	Lance-leaf coreopsis	Plugs – 1 gal.	1 plant/18” o.c.	Moist-dry	Yellow	6-8’
<i>Eupatorium purpureum</i>	Sweet Joe-Pye Weed (Dwarf)	Plugs – 1 gal.	1 plant/24” o.c.	Wet-moist	Purple	3-6’
<i>Iris virginica</i>	Flag Iris	Plugs – 1 gal.	1 plant/18” o.c.	Moist-Wet	Blue	2’
<i>Liatris spicata</i>	Dense blazingstar	Plugs – 1 gal.	1 plant/24” o.c.	Wet-moist	Purple	1.5’
<i>Penstemon digitalis</i>	Smooth white beardtongue	Plugs – 1 gal.	1 plant/24” o.c.	Wet	White	2-3’
<i>Salvia lyrata</i>	Lyre-leaf sage	Plugs – 1 gal.	1 plant/18” o.c.	Moist	Purple	1-2’

Table GIP-02-04. Popular Native Perennials Suitable for Tree Planters – Shade						
Latin Name	Common Name	Size	Spacing	Moisture	Color	Height
<i>Aquilegia canadensis</i>	Wild columbine	Plugs – 1 gal.	1 plant/18” o.c.	Moist-dry	Pink	1-2.5’
<i>Aster novae-angliae</i>	New England aster	Plugs – 1 gal.	1 plant/24” o.c.	Moist-dry	Blue/ purple	3-4’
<i>Aster oblongifolius</i>	Aromatic Aster	Plugs – 1 gal.	1 plant/24” o.c.	Moist-dry	Blue/ purple	1.5-3’
<i>Coreopsis lanceolata</i>	Tickseed coreopsis	Plugs – 1 gal.	1 plant/18” o.c.	Moist-dry	Yellow	3’
<i>Heuchera americana</i>	Alumroot	Plugs – 1 gal.	1 plant/18” o.c.	Moist-dry	Purple	1’

DT: Drought Tolerant

FT: Flood Tolerant



**Table GIP-02-05. Popular Native Grasses and Sedges Suitable for Tree Planters**

Latin Name	Common Name	Size	Spacing	Moisture	Color	Height
<i>Carex muskingumensis</i>	Palm Sedge	1 gal.	1 plant/24" o.c.	Moist	Green	3'
<i>Chasmanthium latifolium</i>	Upland Sea Oats	Plugs – 1 gal.	1 plant/18" o.c.	Moist-dry	Green	4'
<i>Equisetum hyemale</i>	Horsetail	Plugs – 1 gal.	1 plant/18" o.c.	Wet	Green	3'
<i>Juncus effesus</i>	Soft Rush	Plugs – 1 gal.	1 plant/24" o.c.	Wet-dry	Green	4-6'
<i>Muhlenbergia capallaris</i>	Muhly Grass	1 gal.	1 plant/24" o.c.	Moist	Pink	3'
<i>Panicum virgatum</i>	Switchgrass	1-3 gal.	1 plant/48" o.c.	Moist - dry	Yellow	5-7'
<i>Schizachyrium scoparium</i>	Little Blue Stem	1 gal.	1 plant/24" o.c.	Moist-dry	Yellow	3'
<i>Sporobolus heterolepis</i>	Prairie Dropseed	1 gal.	1 plant/24" o.c.	Moist-dry	Green	2-3'

**Table GIP-02-06. Popular Native Trees Suitable for Tree Planters**

Latin Name	Common Name	DT-FT	Light	Moisture	Notes	Flower Color	Height
<i>Acer rubrum</i>	Red Maple	DT-FT	Sun-shade	Dry-wet	Fall color		50-70'
<i>Betula nigra</i>	River Birch	FT	Sun-pt shade	Moist-wet	Exfoliating bark		40-70'
<i>Carpinus caroliniana</i>	Ironwood		Sun-pt shade	Moist		White	40-60'
<i>Carya aquatica</i>	Water Hickory	FT-DT	Sun	Moist	Fall color		35-50'
<i>Cercus Canadensis</i>	Redbud	DT	Sun-shade	Moist	Pea-like flowers, seed pods	Purple	20-30'
<i>Liquidambar styraciflua</i>	Sweetgum (fruitless)	DT-FT	Sun-pt shade	Dry-moist			60-100'
<i>Nyssa sylvatica</i>	Black Gum		Sun-Shade	Moist	Fall color		35-50'
<i>Platanus occidentalis</i>	Sycamore	FT	Sun-pt shade	Moist	White mottled bark		70-100'
<i>Quercus nuttalli</i>	Nuttall Oak	DT	Sun	Dry-moist	Acorns		40-60'
<i>Quercus lyrata</i>	Overcup Oak	FT	Sun	Moist	Acorns		40-60'
<i>Quercus shumardii</i>	Shumard Oak	DT	Sun	Moist	Acorns		40-60'
<i>Ulmus americana</i>	American Elm	DT-FT	Sun-pt shade	Moist			

DT: Drought Tolerant FT: Flood Tolerant





Table GIP-02-07. Popular Native Shrubs Suitable for Tree Planters

Latin Name	Common Name	DT- FT	Light	Moisture	Notes	Flower Color	Height
<i>Clethra alnifolia</i>	Sweet Pepper Bush (Dwarf)		Sun-pt shade	Dry-moist	Hummingbirds	White	5-8'
<i>Hydrangea quercifolia</i>	Oakleaf Hydrangea	DT	Pt shade – shade	Moist		White	3-6'
<i>Hypericum frondosum</i>	Golden St. John's Wort	DT	Sun-pt shade	Dry-moist	Semi-evergreen	Yellow	2-3'
<i>Ilex glabra</i>	Inkberry (Dwarf)	DT	Sun-pt shade	Moist-wet	Evergreen		4-8'

DT: Drought Tolerant  
 FT: Flood Tolerant



## Permeable Pavement



## GIP - 03

Hamilton County



Water Quality Program

**Description:** Permeable pavements allow stormwater runoff to filter through voids in the pavement surface into an underlying stone reservoir, where it is temporarily stored and/or infiltrated. Porous paving systems have several design variants. The four major categories are: 1) pervious concrete; 2) modular block systems; 3) porous asphalt and 4) grass and gravel pavers. All have a similar structure, consisting of a surface pavement layer, an underlying stone aggregate reservoir layer and a filter layer or fabric installed on the bottom.

**Variations:** permeable interlocking pavers, concrete grid pavers, plastic reinforced grid pavers

### Advantages/Benefits:

- Runoff volume reduction
- Can increase aesthetic value
- Provides water quality treatment

### Disadvantages/Limitations:

- Cost
- Maintenance
- Limited to low traffic areas with limited structural loading
- Potential issues with handicap access
- Infiltration can be limited by underlying soil property
- Not effective on steep slopes

### Applications:

- Best used in low traffic and low load bearing areas
- Parking lots (particularly overflow areas)
- Driveways (commercial)
- Sidewalks (outside the Right of Way)
- Emergency access roads, maintenance roads and trails, etc.

### Selection Criteria:

**LEVEL 1 – 45% Runoff Reduction Credit**

**LEVEL 2 – 75% Runoff Reduction Credit**

### Land Use Considerations:

- Residential
- Commercial
- Industrial

### Maintenance:

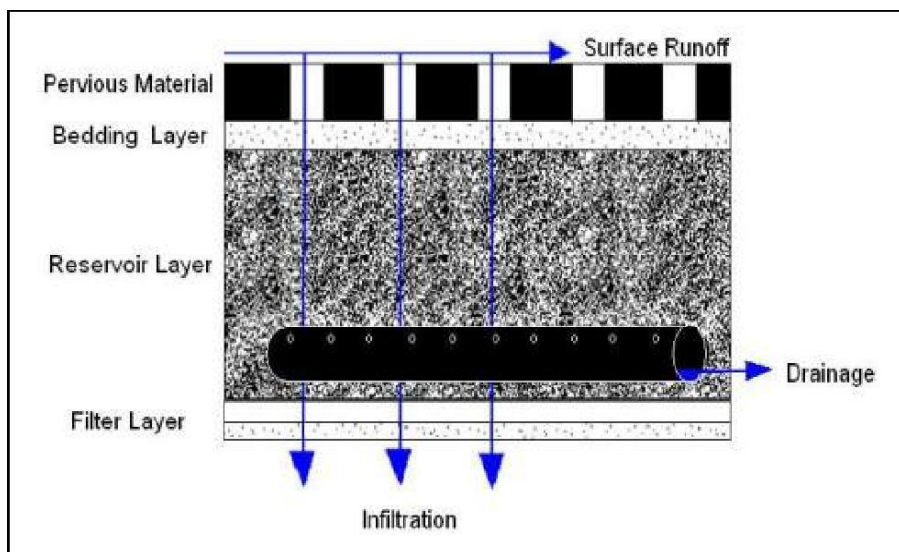
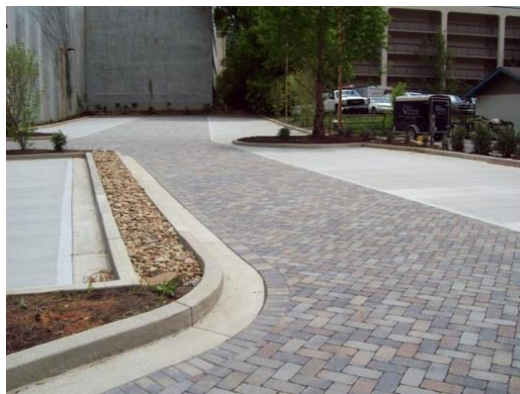
- Turf pavers can require mowing, fertilization, and irrigation. Plowing is possible, but requires use of skids
- Sand and salt should not be applied
- Adjacent areas should be fully stabilized with vegetation to prevent sediment-laden runoff from clogging the surface
- A vacuum-type sweeper or high-pressure hosing (for porous concrete) should be used for cleaning

**H** Maintenance Burden  
 L = Low M = Moderate H = High



## GIP – 03 SECTION 1: DESCRIPTION

Permeable pavements are alternative paving surfaces that allow stormwater runoff to filter through voids in the pavement surface into an underlying stone reservoir, where it is temporarily stored and/or infiltrated. Permeable pavements consist of a surface pavement layer, an underlying stone aggregate reservoir layer and a filter layer or fabric installed on the bottom (See **Figure GIP-03-01** below). The thickness of the reservoir layer is determined by both a structural and hydrologic design analysis. The reservoir layer serves to retain stormwater and also supports the design traffic loads for the pavement. In low-infiltration soils, some or all of the filtered runoff is collected in an underdrain and returned to the storm drain system. If infiltration rates in the native soils permit, permeable pavement can be designed without an underdrain, to enable full infiltration of runoff. A combination of these methods can be used to infiltrate a portion of the filtered runoff.



**Figure GIP-03-01. Cross Section of Typical Permeable Pavement (Source: Hunt & Collins, 2008)**

Permeable pavement is typically designed to treat stormwater that falls on the actual pavement surface area, but it may also be used to accept run-on from small adjacent impervious areas, such as impermeable driving lanes or rooftops. However, careful sediment control is needed for any run-on areas to avoid clogging of the down-gradient permeable pavement. Permeable pavement has been used at commercial, institutional, and residential sites in spaces that are traditionally impervious. Permeable pavement promotes a high degree of runoff volume reduction and nutrient removal, and it can also reduce the effective impervious cover of a development site.

## GIP – 03 SECTION 2: PERFORMANCE

The overall runoff reduction of permeable pavement is shown in **Table GIP-03-01**.





Table 3.1. Runoff Volume Reduction Provided by Permeable Pavement		
Stormwater Function	Level 1 Design	Level 2 Design
Runoff Volume Reduction (RR)	45%	75%

Sources: CSN (2008) and CWP (2007)

### GIP – 03 SECTION 3: DESIGN TABLE

The major design goal of Permeable Pavement is to maximize runoff reduction. To this end, designers may choose to use a baseline permeable pavement design (Level 1) or an enhanced design (Level 2) that maximizes runoff reduction. To qualify for Level 2, the design must meet all design criteria shown in the right hand column of **Table GIP-03-02**.

Table GIP-03-02. Permeable Pavement Design Criteria	
Level 1 Design	Level 2 Design
$Tv^1 = (1)(Rv)(A) 3630$	$Tv = (1.1)(Rv)(A) 3630$
Soil infiltration $\leq 0.5$ in./hr.	Soil infiltration rate $> 0.5$ in./hr.
Maximum contributing drainage area is twice the permeable surface area.	The permeable material handles only rainfall on its surface.
Underdrain required	Underdrain not required; <b>OR</b> If an underdrain is used, a 12-inch stone sump must be provided below the underdrain invert

1. A = Area in acres

### GIP – 03 SECTION 4: TYPICAL DETAILS

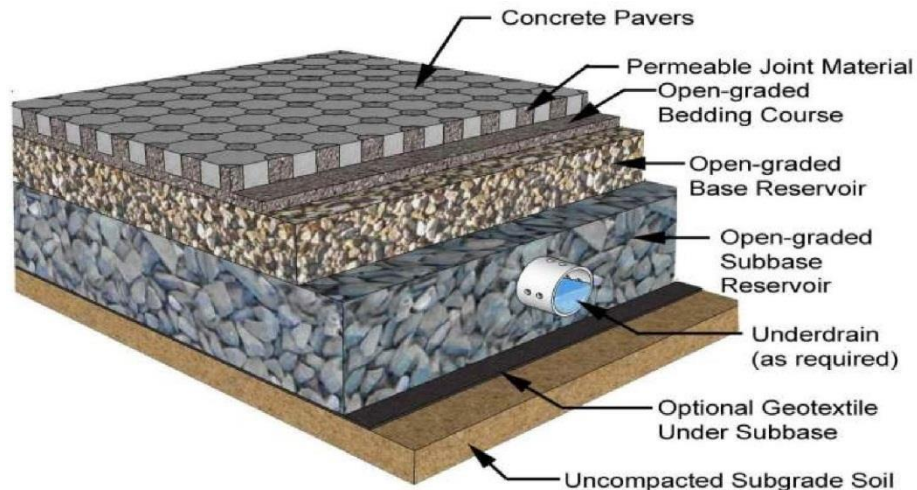
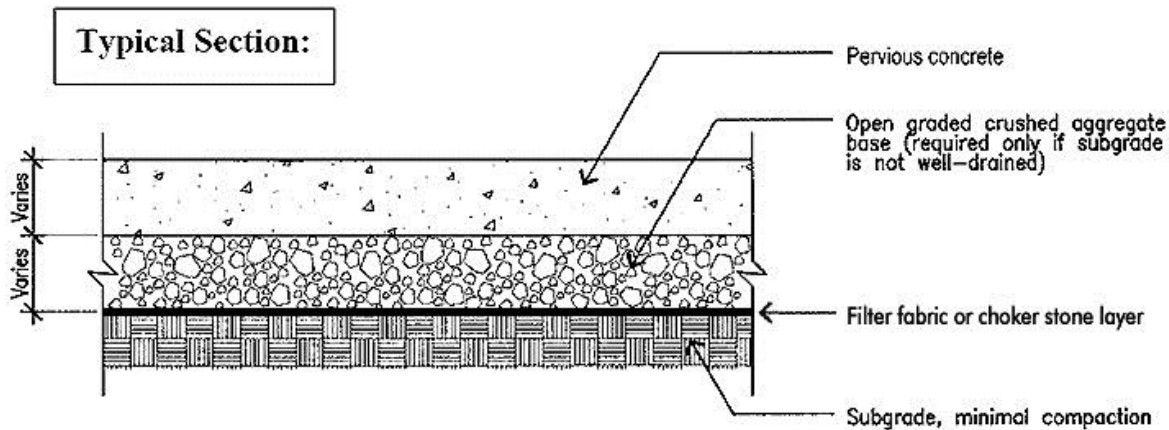


Figure GIP-03-02. Typical Detail of Concrete Paver (Source: Smith, 2009)



### *Pervious Concrete Mixes*



**Figure GIP-03-03. Typical Detail of Pervious Concrete (Source: Portland, 2003)**

## **GIP – 03 SECTION 5: PHYSICAL FEASIBILITY & DESIGN APPLICATIONS**

Since permeable pavement has a very high runoff reduction capability, it should always be considered as an alternative to conventional pavement. Permeable pavement is subject to the same feasibility constraints as most infiltration practices, as described below.

**Available Space.** A prime advantage of permeable pavement is that it does not normally require additional space at a new development or redevelopment site, which can be important for tight sites or areas where land prices are high.

**Soils.** Soil conditions do not constrain the use of permeable pavement, although they do determine whether an underdrain is needed. Impermeable soils in Hydrologic Soil Groups (HSG) C or D usually require an underdrain, whereas HSG A and B soils often do not. In addition, permeable pavement should never be situated above fill soils unless designed with an impermeable liner and underdrain.

If the proposed permeable pavement area is designed to infiltrate runoff without underdrains, it must have a minimum infiltration rate of 0.5 inches per hour. Initially, projected soil infiltration rates can be estimated from USDA-NRCS soil data, but they must be confirmed by an on-site infiltration measurement. Native soils should have silt/clay content less than 40% and clay content less than 20%.

**Designers should also evaluate existing soil properties during initial site layout, and seek to configure the site to conserve and protect the soils with the greatest recharge and infiltration rates. In particular, areas of HSG A or B soils shown on NRCS soil surveys should be considered as primary locations for all types of infiltration.**

**External Drainage Area.** Any external drainage area contributing runoff to permeable pavement should not exceed twice the surface area of the permeable pavement (for Level 1 design), and it should be as close to 100% impervious as possible. Some field experience has shown that an upgradient drainage area (even if it is impervious) can contribute particulates to the permeable pavement and lead to clogging (Hirschman, et al., 2009).



Therefore, careful sediment source control and/or a pre-treatment strip or sump (e.g., stone or gravel) should be used to control sediment run-on to the permeable pavement section.

**Pavement Slope.** Steep slopes can reduce the stormwater storage capability of permeable pavement and may cause shifting of the pavement surface and base materials. Designers should consider using a terraced design for permeable pavement in sloped areas, especially when the local slope is several percent or greater. The bottom slope of a permeable pavement installation should be as flat as possible (i.e., 0% longitudinal slope) to enable even distribution and infiltration of stormwater. However, a maximum longitudinal slope of 1% is permissible if an underdrain is employed. Lateral slopes should be 0%.

**Minimum Hydraulic Head.** The elevation difference needed for permeable pavement to function properly is generally nominal, although 2 to 4 feet of head may be needed to drive flows through underdrains. Flat terrain may affect proper drainage of Level 1 permeable pavement designs, so underdrains should have a minimum 0.5% slope.

**Minimum Depth to Water Table.** A high groundwater table may cause runoff to pond at the bottom of the permeable pavement system. Therefore, a minimum vertical distance of 2 feet must be provided between the bottom of the permeable pavement installation (i.e., the bottom invert of the reservoir layer) and the seasonal high water table.

**Setbacks.** Permeable pavement should not be hydraulically connected to structure foundations, in order to avoid harmful seepage. Setbacks to structures and roads vary, based on the scale of the permeable pavement installation (see **Table 3.3** below). At a minimum, small- and large-scale pavement applications should be located a minimum horizontal distance of 100 feet from any water supply well, 50 feet from septic systems, and at least 5 feet down-gradient from dry or wet utility lines.

**Informed Owner.** The property owner should clearly understand the unique maintenance responsibilities inherent with permeable pavement, particularly for parking lot applications. The owner should be capable of performing routine and long-term actions (e.g., vacuum sweeping) to maintain the pavement's hydrologic functions, and avoid future practices (e.g., winter sanding, seal coating or repaving) that diminish or eliminate them.

**High Loading Situations.** Permeable pavement is not intended to treat sites with high sediment or trash/debris loads, since such loads will cause the practice to clog and fail.

**Groundwater Protection.** Section 10 of the Bioretention specification (GIP-01) presents a list of potential stormwater hotspots that pose a risk of groundwater contamination. Infiltration of runoff from designated hotspots is highly restricted or prohibited.

**Limitations.** Permeable pavement can be used as an alternative to most types of conventional pavement at residential, commercial and institutional developments; however, it is not currently approved for use in the Right of Way (ROW).

**Design Scales.** Permeable pavement can be installed at the following three scales:

1. The smallest scale is termed **Micro-Scale Pavements**, which applies to converting impervious surfaces to permeable ones on small lots and redevelopment projects, where the installations may range from 250 to 1000 square feet in total area. Where redevelopment or retrofitting of existing impervious areas results in a larger foot-print of permeable pavers (small-scale or large-scale, as described below), the designer should





implement the Load Bearing, Observation Well, Underdrain, Soil Test, and Building Setback criteria associated with the applicable scale.

2. **Small-scale pavement** applications treat portions of a site between 1,000 and 10,000 square feet in area, and include areas that only occasionally receive heavy vehicular traffic.
3. **Large scale pavement** applications exceed 10,000 square feet in area and typically are installed within portions of a parking lot.

**Table GIP-03-03** outlines the different design requirements for each of the three scales of permeable pavement installation.

Table GIP-03-03. The Three Design Scales for Permeable Pavement			
Design Factor	Micro-Scale Pavement	Small-Scale Pavement	Large-Scale Pavement
<b>Impervious Area Treated</b>	250 to 1,000 sq. ft.	1,000 to 10,000 sq. ft.	More than 10,000 sq. ft.
<b>Typical Applications</b>	Driveways Walkways Courtyards Plazas Individual Sidewalks	Sidewalk Network Fire Lanes Road Shoulders (private) Spill-Over Parking Plazas	Parking Lots with more than 40 spaces
<b>Load Bearing Capacity</b>	Foot traffic Light vehicles	Light vehicles	Heavy vehicles (moving & parked)
<b>Reservoir Size</b>	Infiltrate or detain some or all of the $T_v$	Infiltrate or detain the full $T_v$	
<b>External Drainage Area?</b>	No	Impervious cover up to twice with Level 1 design.	Impervious cover up to twice with Level 1 design.
<b>Observation Well</b>	No	No	Yes
<b>Underdrain?</b>	Rare	Depends on the soils	Back-up underdrain
<b>Required Soil Tests</b>	Two per practice	Four per practice	Four + one per every additional 5000 ft <sup>2</sup>
<b>Suggested Building Setbacks</b>	5 feet down-gradient 25 feet up-gradient	10 feet down-gradient 50 feet up-gradient	25 feet down-gradient 100 feet up-gradient

Regardless of the design scale of the permeable pavement installation, the designer should carefully consider the expected traffic load at the proposed site and the consequent structural requirements of the pavement system. Sites with heavy traffic loads will require a thick aggregate base. Sites with heavy traffic loads will require a thick aggregate base and, in the case of porous asphalt and pervious concrete, may require the addition of an admixture for strength or a specific bedding design. In contrast, most micro-scale applications should have little or no traffic flow to contend with.

## GIP – 03 SECTION 6: DESIGN CRITERIA

### 6.1 Sizing of Permeable Pavement

**Structural Design.** If permeable pavement will be used in a parking lot or other setting that involves vehicles, the pavement surface must be able to support the maximum anticipated traffic load. The structural design process will vary according to the type of pavement selected, and the manufacturer’s specific recommendations should be consulted. The thickness of the permeable pavement and reservoir layer must be sized to support structural loads and to temporarily store the design storm volume (e.g., the water quality, channel protection, and/or flood



control volumes). On most new development and redevelopment sites, the structural support requirements will dictate the depth of the underlying stone reservoir.

The structural design of permeable pavements involves consideration of four main site elements:

- ❖ Total traffic;
- ❖ In-situ soil strength;
- ❖ Environmental elements; and
- ❖ Bedding and Reservoir layer design.

The resulting structural requirements may include, but are not limited to, the thickness of the pavement, filter, and reservoir layer. Designers should note that if the underlying soils have a low California Bearing Ratio (CBR) (less than 4%), they may need to be compacted to at least 95% of the Standard Proctor Density, which generally rules out their use for infiltration.

Designers should determine structural design requirements by consulting transportation design guidance sources, such as the following:

- ❖ TDOT Roadway Design Guidelines (2010; or latest edition);
- ❖ AASHTO Guide for Design of Pavement Structures (1993); and,
- ❖ AASHTO Supplement to the Guide for Design of Pavement Structures (1998).

**Hydraulic Design.** Permeable pavement is typically sized to store the complete water quality Treatment Volume ( $T_v$ ) or another design storm volume in the reservoir layer. Modeling has shown that this simplified sizing rule approximates an 80% average rainfall volume removal for subsurface soil infiltration rates up to one inch per hour. More conservative values are given because both local and national experience has shown that clogging of the permeable material can be an issue, especially with larger contributing areas carrying significant soil materials onto the permeable surface.

The infiltration rate typically will be less than the flow rate through the pavement, so that some underground reservoir storage will usually be required. Designers should initially assume that there is no outflow through underdrains, using **Equation GIP-03-01** to determine the depth of the reservoir layer, assuming runoff fully infiltrates into the underlying soil:

**Equation GIP-03-01. Depth of Reservoir Layer with no Underdrain**

$$d_p = \frac{\{(d_c \times R) + P - (i/2 \times t_f)\}}{n}$$

Where:

- $d_p$  = The depth of the reservoir layer (ft.)
- $d_c$  = The depth of runoff from the contributing drainage area (not including the permeable paving surface) for the Treatment Volume ( $T_v/A_c$ ), or other design storm (ft.)
- $R$  =  $A_c/A_p$  = The ratio of the contributing drainage area ( $A_c$ , not including the permeable paving surface) to the permeable pavement surface area ( $A_p$ ) [NOTE: With reference to **Table 3.3**, the maximum value for the Level 1 design is  $R = 2$ , (the external drainage area  $A_c$  is twice that of the permeable pavement area  $A_p$ ; and for Level 2 design  $R = 0$  (the drainage area is made up solely of permeable pavement  $A_p$ ).
- $P$  = The rainfall depth for the Treatment Volume (Level 1 = 1 inch; Level 2 = 1.1 inch), or other design storm (ft.)
- $i$  = The field-verified infiltration rate for native soils (ft./day)



- $t_f$  = The time to fill the reservoir layer (day) – typically 2 hours or 0.083 day
- $n$  = The porosity for the reservoir layer (0.4)

The maximum allowable depth of the reservoir layer is constrained by the maximum allowable drain time, which is calculated using **Equation GIP-03-02**.

**Equation GIP-03-02. Maximum Depth of Reservoir Layer**

$$d_{p-max} = \frac{(i/2 \times t_d)}{n}$$

Where:

- $d_{p-max}$  = The maximum depth of the reservoir layer (ft.)
- $i$  = The field-verified infiltration rate for native soils (ft./day)
- $t_d$  = The maximum allowable time to drain the reservoir layer, typically 1 to 2 days
- $n$  = The porosity for the reservoir layer (0.4)

The following design assumptions apply to **Equations GIP-03-01 and GIP-03-02**:

- ❖ The contributing drainage area ( $A_c$ ) should not contain pervious areas.
- ❖ For design purposes, the native soil infiltration rate ( $i$ ) should be the field-tested soil infiltration rate divided by a factor of safety of 2. The minimum acceptable native soil infiltration rate is 0.5 inches/hr.
- ❖ The porosity ( $n$ ) for No. 57 stone = 0.40
- ❖ Max. drain time for the reservoir layer should be not less than 24 or more than 48 hours.

If the depth of the reservoir layer is too great (i.e.  $d_p$  exceeds  $d_{p-max}$ ), or the verified soil infiltration rate is less than 0.5 inches per hour, then the design method typically changes to account for underdrains. The storage volume in the pavements must account for the underlying infiltration rate and outflow through the underdrain. In this case, the design storm should be routed through the pavement to accurately determine the required reservoir depth. Alternatively, the designer may use **Equations 3.3 through 3.5** to approximate the depth of the reservoir layer for designs using underdrains.

**Equation GIP-03-03** can be used to approximate the outflow rate from the underdrain. The hydraulic conductivity,  $k$ , of gravel media is very high (~17,000 ft./day). However, the permeable pavement reservoir layer will drain increasingly slower as the storage volume decreases (i.e. the hydraulic head decreases). To account for this change, a conservative permeability coefficient of 100 ft./day can be used to approximate the average underdrain outflow rate.

**Equation GIP-03-03. Outflow through Underdrain**

$$q_u = k \times m$$

Where:

- $q_u$  = Outflow through the underdrain (per outlet pipe, assumed 6-inch diameter)(ft./day)
- $k$  = Hydraulic conductivity for the reservoir layer (ft./day – assume 100 ft./day)
- $m$  = Underdrain pipe slope (ft./ft.)

Once the outflow rate through the underdrain has been approximated, **Equation 3.4** is used to determine the depth of the reservoir layer needed to store the design storm.





**Equation GIP-03-04. Depth of Reservoir Layer with Outflow through Underdrain**

$$d_p = \frac{\{(d_c \times R) + P - (i/2 \times t_f) - (q_u \times t_f)\}}{n}$$

Where:

- $d_p$  = Depth of the reservoir layer (ft.)
- $d_c$  = Depth of runoff from the contributing drainage area (not including the permeable pavement surface) for the Treatment Volume (Tv/ $A_c$ ), or other design storm (ft.)
- $R$  =  $A_c/A_p$  = The ratio of the contributing drainage area ( $A_c$ ) (not including the permeable pavement surface) to the permeable pavement surface area ( $A_p$ )
- $P$  = The rainfall depth for the Treatment Volume (Level 1 = 1 inch; Level 2 = 1.1 inch), or other design storm (ft.)
- $i$  = The field-verified infiltration rate for the native soils (ft./day)
- $t_f$  = The time to fill the reservoir layer (day) – typically 2 hours or 0.083 day
- $n$  = The porosity for the reservoir layer (0.4)
- $q_u$  = Outflow through Underdrain (ft/day)

The maximum allowable depth of the reservoir layer is constrained by the maximum allowable drain time, which is calculated using **Equation GIP-03-05**.

**Equation GIP-03-05. Maximum Depth of Reservoir Layer with Outflow through Underdrain**

$$d_{p-max} = \frac{\{(i/2 \times t_d) - (q_u \times t_d)\}}{n}$$

Where:

- $d_{p-max}$  = The maximum depth of the reservoir layer (ft.)
- $i$  = The field-verified infiltration rate for the native soils (ft./day)
- $n$  = The porosity for the reservoir layer (0.4)
- $t_d$  = The time to drain the reservoir layer (day – typically 1 to 2 days)
- $q_u$  = Outflow through Underdrain (ft/day)

If the depth of the reservoir layer is still too great (i.e.  $d_p$  exceeds  $d_{p-max}$ ), the number of underdrains can be increased, which will increase the underdrain outflow rate.

Permeable pavement can also be designed to address, in whole or in part, the detention storage needed to comply with channel protection and/or flood control requirements. The designer can model various approaches by factoring in storage within the stone aggregate layer, expected infiltration, and any outlet structures used as part of the design. Routing calculations can also be used to provide a more accurate solution of the peak discharge and required storage volume.

Once runoff passes through the surface of the permeable pavement system, designers should calculate outflow pathways to handle subsurface flows. Subsurface flows can be regulated using underdrains, the volume of storage in the reservoir layer, and the bed slope of the reservoir layer.



## 6.2 Soil Infiltration Rate Testing

To design a permeable pavement system *without* an underdrain, the measured infiltration rate of subsoils must be 0.5 inches per hour or greater. On-site soil infiltration rate testing procedures are outlined in Appendix 3-A. A minimum of two tests must be taken for micro-scale pavements, four tests for small-scale, and four tests plus one for every additional 5,000 sq. ft. of large-scale pavement. The same frequency of soil borings must be taken to confirm the underlying soil properties *at the depth where infiltration is designed to occur* (i.e., to ensure that the depth to water table, depth to bedrock, or karst is defined). Soil infiltration testing should be conducted within any confining layers that are found within 4 feet of the bottom of a proposed permeable pavement system.

## 6.3 Type of Surface Pavement

Pervious concrete, porous asphalt, permeable interlocking concrete pavers, concrete grid pavers, and plastic reinforced grid paver surfaces are permitted.

## 6.4 Internal Geometry and Drawdowns

- ❖ **Elevated Underdrain.** To promote greater runoff reduction for permeable pavement located on marginal soils, an elevated underdrain should be installed with a stone jacket that creates a 12 to 18 inch deep storage layer *below* the underdrain invert. The void storage in this layer can help qualify a site to achieve Level 2 design.
- ❖ **Rapid Drawdown.** When possible, permeable pavement should be designed so that the target runoff reduction volume stays in the reservoir layer for at least 36 hours before being discharged through an underdrain.
- ❖ **Conservative Infiltration Rates.** Designers should always decrease the measured infiltration rate by a factor of 2 during design, to approximate long term infiltration rates.

## 6.5 Pretreatment

Pretreatment for most permeable pavement applications is not necessary, since the surface acts as pretreatment to the reservoir layer below.

## 6.6 Conveyance and Overflow

Permeable pavement designs should include methods to convey larger storms (e.g., 2-yr, 10-yr) to the storm drain system. The following is a list of methods that can be used to accomplish this:

- ❖ Place a perforated pipe horizontally near the top of the reservoir layer to pass excess flows after water has filled the base. The placement and/or design should be such that the incoming runoff is not captured (e.g., placing the perforations on the underside only).
- ❖ Increase the thickness of the top of the reservoir layer by as much as 6 inches (i.e., create freeboard). The design computations used to size the reservoir layer often assume that no freeboard is present.
- ❖ Create underground detention within the reservoir layer of the permeable pavement system. Reservoir storage may be augmented by corrugated metal pipes, plastic or concrete arch structures, etc.
- ❖ Route excess flows to another detention or conveyance system that is designed for the management of extreme event flows.
- ❖ Set the storm drain inlets flush with the elevation of the permeable pavement surface to effectively convey excess stormwater runoff past the system (typically in remote areas). The design should also make allowances for relief of unacceptable ponding depths during larger rainfall events.



### 6.7 Reservoir layer

The thickness of the reservoir layer is determined by runoff storage needs, the infiltration rate of in situ soils, structural requirements of the pavement sub-base, depth to water table and bedrock, and frost depth conditions. A professional should be consulted regarding the suitability of the soil subgrade.

- ❖ The reservoir below the permeable pavement surface should be composed of clean, washed stone aggregate and sized for both the storm event to be treated and the structural requirements of the expected traffic loading.
- ❖ The storage layer may consist of clean washed No. 57 stone, although No. 2 stone is preferred because it provides additional storage and structural stability.
- ❖ The bottom of the reservoir layer should be completely flat so that runoff will be able to infiltrate evenly through the entire surface.

### 6.8 Underdrains

The use of underdrains is recommended when there is a reasonable potential for infiltration rates to decrease over time, when underlying soils have an infiltration rate of 0.5 inches per hour or less, when shallow bedrock is present, or when soils must be compacted to achieve a desired Proctor density. Underdrains can also be used to manage extreme storm events to keep detained stormwater from backing up into the permeable pavement.

- ❖ An underdrain(s) should be placed within the reservoir and encased in 8 to 12 inches of clean, washed stone.
- ❖ The underdrain outlet can be fitted with a flow-reduction orifice as a means of regulating the stormwater detention time. The minimum diameter of any orifice should be 0.5 inch.
- ❖ An underdrain(s) can also be installed and capped at a downstream structure as an option for future use if maintenance observations indicate a reduction in the soil permeability.

### 6.9 Maintenance Reduction Features

Maintenance is a crucial element to ensure the long-term performance of permeable pavement. The most frequently cited maintenance problem is surface clogging caused by organic matter and sediment, which can be reduced by the following measures:

- ❖ **Periodic Vacuum Sweeping.** The pavement surface is the first line of defense in trapping and eliminating sediment that may otherwise enter the stone base and soil subgrade. The rate of sediment deposition should be monitored and vacuum sweeping done once or twice a year. This frequency should be adjusted according to the intensity of use and deposition rate on the permeable pavement surface. At least one sweeping pass should occur at the end of winter.
- ❖ **Protecting the Bottom of the Reservoir Layer.** There are two options to protect the bottom of the reservoir layer from intrusion by underlying soils. The first method involves covering the bottom with nonwoven, polypropylene geotextile that is permeable, although some practitioners recommend avoiding the use of filter fabric since it may become a future plane of clogging within the system. Permeable filter fabric is still recommended to protect the excavated sides of the reservoir layer, in order to prevent soil piping. The second method is to form a barrier of choker stone and sand. In this case, underlying native soils should be separated from the reservoir base/subgrade layer by a thin 2 to 4 inch layer of clean, washed, choker stone (ASTM D 448 No. 8 stone) covered by a layer of 6 to 8 inches of course sand.
- ❖ **Observation Well.** An observation well, consisting of a well-anchored, perforated 4 to 6 inch (diameter) PVC pipe that extends vertically to the bottom of the reservoir layer, should be installed at the downstream end of all large-scale permeable pavement systems. The observation well should be fitted with a lockable cap installed flush with the ground surface (or under the pavers) to facilitate periodic inspection and maintenance. The observation well is used to observe the rate of drawdown within the reservoir layer following a storm event.





- ❖ **Overhead Landscaping.** Check the area of parking lots required to be in landscaping. Large-scale permeable pavement applications should be carefully planned to integrate this landscaping in a manner that maximizes runoff treatment and minimizes the risk that sediment, mulch, grass clippings, leaves, nuts, and fruits will inadvertently clog the paving surface.

## GIP – 03 SECTION 7: Material Specifications

Permeable pavement material specifications vary according to the specific pavement product selected. **Table GIP-03-04** describes general material specifications for the component structures installed beneath the permeable pavement. **Table GIP-03-05** provides specifications for general categories of permeable pavements. Designers should consult manufacturer’s technical specifications for specific criteria and guidance.

Table GIP-03-04. Material Specifications for Underneath the Pavement Surface		
Material	Specification	Notes
<b>Bedding Layer</b>	Pervious Concrete: None Interlocking Pavers: 2 in. depth of No. 8 stone over 3 to 4 inches of No. 57	ASTM D448 size No. 8 stone (e.g. 3/8 to 3/16 inch in size). Should be double-washed and clean and free of all fines.
<b>Reservoir Layer</b>	Pervious Concrete: No. 57 or No. 2 stone Interlocking Pavers: No. 57 or No. 2 stone	ASTM D448 size No. 57 stone (e.g. 1 1/2 to 1/2 inch in size); No. 2 Stone (e.g. 3 inch to 3/4 inch in size). Depth is based on the pavement structural and hydraulic requirements. Should be double-washed and clean and free of all fines.
<b>Underdrain</b>	Use 4 to 6 inch diameter perforated HDPE or PVC (AASHTO M 252) pipe, with 3/8-inch perforations at 6 inches on center; each underdrain installed at a minimum 0.5% slope located 20 feet or less from the next pipe (or equivalent corrugated HDPE may be used for smaller load-bearing applications). Perforated pipe installed for the full length of the permeable pavement cell, and non-perforated pipe, as needed, is used to connect with the storm drain system. T’s and Y’s installed as needed, depending on the underdrain configuration. Extend cleanout pipes to the surface with vented caps at the Ts and Ys.	
<b>Either Filter Layer or (See Filter Fabric below)</b>	The underlying native soils should be separated from the stone reservoir by a thin, 2 to 4 inch layer of choker stone (e.g. No. 8) covered by a 6 to 8 inch layer of coarse sand (e.g. ASTM C 33, 0.02-0.04 inch).	The sand should be placed between the stone reservoir and the choker stone, which should be placed on top of the underlying native soils.
<b>Filter Fabric (optional)</b>	Use a needled, non-woven, polypropylene geotextile with Grab Tensile Strength equal to or greater than 120 lbs. (ASTM D4632), with a Mullen Burst Strength equal to or greater than 225 lbs./sq. in. (ASTM D3786), with a Flow Rate greater than 125 gpm/sq. ft. (ASTM D4491), and an Apparent Opening Size (AOS) equivalent to a US # 70 or # 80 sieve (ASTM D4751). The geotextile AOS selection is based on the percent passing the No. 200 sieve in “A” Soil subgrade, using FHWA or AASHTO selection criteria.	
<b>Impermeable Liner (if needed)</b>	Use a thirty mil (minimum) PVC Geomembrane liner covered by 8 to 12 oz./sq. yd. <sup>2</sup> non-woven geotextile.	
<b>Observation Well</b>	Use a perforated 4 to 6 inch vertical PVC pipe (AASHTO M 252) with a lockable cap, installed flush with the surface.	



**Table GIP-03-05. Different Permeable Pavement Specifications**

Material	Specification	Notes
<b>Permeable Interlocking Concrete Pavers</b>	Surface open area: 5% to 15%. Thickness: 3.125 inches for vehicles. Compressive strength: 55 Mpa (~8000 psi). Open void fill media: aggregate	Must conform to ASTM C936 specifications. Reservoir layer required to support the structural load.
<b>Concrete Grid Pavers</b>	Open void content: 20% to 50%. Thickness: 3.5 inches. Compressive strength: 35 Mpa (~5000 psi). Open void fill media: aggregate, topsoil and grass, coarse sand.	Must conform to ASTM C 1319 specifications. Reservoir layer required to support the structural load.
<b>Plastic Reinforced Grid Pavers</b>	Void content: depends on fill material. Compressive strength: varies, depending on fill material. Open void fill media: aggregate, topsoil and grass, coarse sand.	Reservoir layer required to support the structural load.
<b>Pervious Concrete</b>	Void content: 15% to 25 %. Thickness: typically 4 to 8 inches. Compressive strength: 2.8 to 28 Mpa. Open void fill media: None	May not require a reservoir layer to support the structural load, but a layer may be included to increase the storage or infiltration.
<b>Porous Asphalt</b>	Void content: 15% to 20 %. Thickness: typically 3 to 7 in. (depending on traffic load). Open void fill media: None.	Reservoir layer required to support the structural load.

## GIP – 03 SECTION 8: SPECIAL CASE DESIGN ADAPTATIONS

The design adaptation described below permits permeable pavement to be used on a wider range of sites.

However, it is important not to force this practice onto marginal sites. Other runoff reduction practices are often preferred alternatives for difficult sites.

### 8.1 Shallow Bedrock

Underdrains must be used in locations in which bedrock is encountered less than 2 feet beneath the planned invert of the reservoir layer.

## GIP – 03 SECTION 9: CONSTRUCTION

Experience has shown that proper installation is absolutely critical to the effective operation of a permeable pavement system.

### 9.1 Necessary Erosion & Sediment Controls

- ❖ All permeable pavement areas should be fully protected from sediment intrusion by silt fence or construction fencing, particularly if they are intended to infiltrate runoff.
- ❖ Permeable pavement areas should remain outside the limit of disturbance during construction to prevent soil compaction by heavy equipment. Permeable pavement areas should be clearly marked on all construction



documents and grading plans. To prevent soil compaction, heavy vehicular and foot traffic should be kept out of permeable pavement areas during and immediately after construction.

- ❖ During construction, care should be taken to avoid tracking sediments onto any permeable pavement surface to avoid clogging.
- ❖ Any area of the site intended ultimately to be a permeable pavement area should generally not be used as the site of a temporary sediment basin.
- ❖ Where locating a sediment basin on an area intended for permeable pavement is unavoidable, the invert of the sediment basin must be a minimum of 2 feet above the final design elevation of the bottom of the aggregate reservoir course.
- ❖ All sediment deposits in the excavated area should be carefully removed prior to installing the subbase, base and surface materials

## 9.2 Permeable Pavement Construction Sequence

The following is a typical construction sequence to properly install permeable pavement:

**Step 1.** Construction of the permeable pavement shall only begin after the entire contributing drainage area has been stabilized. The proposed site should be checked for existing utilities prior to any excavation. Do not install the system in rain or snow, and do not install frozen bedding materials.

**Step 2.** As noted above, temporary EPSC measures are needed during installation to divert stormwater away from the permeable pavement area until it is completed. Special protection measures such as erosion control fabrics may be needed to protect vulnerable side slopes from erosion during the excavation process. The proposed permeable pavement area must be kept free from sediment during the entire construction process. Construction materials that are contaminated by sediments must be removed and replaced with clean materials.

**Step 3.** Where possible, excavators or backhoes should work from the sides to excavate the reservoir layer to its appropriate design depth and dimensions. For micro-scale and small-scale pavement applications, excavating equipment should have arms with adequate extension so they do not have to work inside the footprint of the permeable pavement area (to avoid compaction). Contractors can utilize a cell construction approach, whereby the proposed permeable pavement area is split into 500 to 1000 sq. ft. temporary cells with a 10 to 15 foot earth bridge in between, so that cells can be excavated from the side. Excavated material should be placed away from the open excavation so as to not jeopardize the stability of the side walls.

**Step 4.** The native soils along the bottom and sides of the permeable pavement system should be scarified or tilled to a depth of 3 to 4 inches prior to the placement of the filter layer or filter fabric. In large scale paving applications with weak soils, the soil subgrade may need to be compacted to 95% of the Standard Proctor Density to achieve the desired load-bearing capacity. (NOTE: This effectively eliminates the infiltration function of the installation, and it must be addressed during hydrologic design.)

**Step 5.** If filter fabric is to be installed on the bottom and the sides of the reservoir layer, the strips should overlap down-slope by a minimum of 2 feet, and be secured a minimum of 4 feet beyond the edge of the excavation. Where the filter layer extends beyond the edge of the pavement (to convey runoff to the reservoir layer), install an additional layer of filter fabric 1 foot below the surface to prevent sediments from entering into the reservoir layer. Excess filter fabric should not be trimmed until the site is fully stabilized.

**Step 6.** Provide a minimum of 2 inches of aggregate above and below the underdrains. The underdrains should slope down towards the outlet at a grade of 0.5% or steeper. The up-gradient end of underdrains in the reservoir





layer should be capped. Where an underdrain pipe is connected to a structure, there shall be no perforations within 1 foot of the structure. Ensure that there are no perforations in clean-outs and observation wells within 1 foot of the surface.

**Step 7.** Moisten and spread 6-inch lifts of the appropriate clean, washed stone aggregate (usually No. 2 or No. 57 stone). Place at least 4 inches of additional aggregate above the underdrain, and then compact it using a vibratory roller in static mode until there is no visible movement of the aggregate. Do not crush the aggregate with the roller.

**Step 8.** Install the bedding layer. The thickness of the bedding layer is to be based on the block manufacturer's recommendation or that of a qualified professional.

**Step 9.** Paving materials shall be installed in accordance with manufacturer or industry specifications for the particular type of pavement.

### 9.3 Construction Inspection

Inspections before, during and after construction are needed to ensure that permeable pavement is built in accordance with these specifications. Use detailed inspection checklists that require sign-offs by qualified individuals at critical stages of construction, to ensure that the contractor's interpretation of the plan is consistent with the designer's intent.

Some common pitfalls can be avoided by careful construction supervision that focuses on the following key aspects of permeable pavement installation:

- ❖ Store materials in a protected area to keep them free from mud, dirt, and other foreign materials.
- ❖ The contributing drainage area should be stabilized prior to directing water to the permeable pavement area.
- ❖ Check the aggregate material to confirm that it is clean and washed, meets specifications and is installed to the correct depth.
- ❖ Check elevations (e.g., the invert of the underdrain, inverts for the inflow and outflow points, etc.) and the surface slope.
- ❖ Make sure the permeable pavement surface is even, runoff evenly spreads across it, and the storage bed drains within 48 hours.
- ❖ Inspect the structural integrity of the pavement surface, looking for signs of slumping, cracking, spalling or broken pavers. Replace or repair affected areas.
- ❖ Ensure that caps are placed on the upstream (but not the downstream) ends of the underdrains.
- ❖ Inspect the pretreatment structures (if applicable) to make sure they are properly installed and working effectively.
- ❖ The drawdown rate should be measured at the observation well for three (3) days following a storm event in excess of 0.5 inch in depth. If standing water is still observed in the well after three days, this is a clear sign that clogging is a problem.
- ❖ Once the final construction inspection has been completed, log the GPS coordinates for each facility and submit them to the Program.



## GIP – 03 SECTION 10: AS-BUILT REQUIREMENTS

After the permeable pavement has been installed, an as-built inspection and certification must be performed by a Professional Engineer. The as-built certification verifies that the BMP was installed as designed and approved. The following components must be addressed in the as-built certification:

1. The infiltration rate of the permeable pavement must be verified.
2. The infiltration rate test of the underlying soils should be included if Level 2 is used without an underdrain.
3. Surrounding drainage areas must be stabilized to prevent sediment from clogging the pavement.

## GIP – 03 SECTION 11: MAINTENANCE

### 11.1 Maintenance Document

Each BMP must have a Hamilton County Water Quality Stormwater Management Facility I&M Storm Water Management Facilities Agreement submitted for approval and maintained and updated by the BMP owner. The Stormwater Management Facilities I&M Agreement must be completed and submitted to the Program with the Land Disturbance permit application. The Stormwater Management Facilities I&M Agreement is for the use of the BMP owner in performing routine inspections. The developer/owner is responsible for the cost of maintenance and annual inspections. The BMP owner must maintain and update the BMP inspections and maintenance plan.

### 11.2 Maintenance Tasks

It is difficult to prescribe the specific types or frequency of maintenance tasks that are needed to maintain the hydrologic function of permeable pavement systems over time. Most installations work reasonably well year after year with little or no maintenance, whereas some have problems right from the start.

One preventative maintenance task for large-scale applications involves vacuum sweeping on a frequency consistent with the use and loadings encountered in the parking lot. Many consider an annual, dry-weather sweeping in the spring months to be important. The contract for sweeping should specify that a vacuum sweeper be used that does not use water spray, since spraying may lead to subsurface clogging. Vacuum settings for large-scale interlocking paver applications should be calibrated so they *do not* pick up the stones between pavement blocks.

### 11.3 Maintenance Inspections

It is highly recommended that a spring maintenance inspection and cleanup be conducted at each permeable pavement site, particularly at large-scale applications.

Maintenance of permeable pavement is driven by annual inspections that evaluate the condition and performance of the practice. The following are suggested annual maintenance inspection points for permeable pavements:

- ❖ The drawdown rate should be measured at the observation well for three (3) days following a storm event in excess of 0.5 inch in depth. If standing water is still observed in the well after three days, this is a clear sign that clogging is a problem.
- ❖ Inspect the surface of the permeable pavement for evidence of sediment deposition, organic debris, staining or ponding that may indicate surface clogging. If any signs of clogging are noted, schedule a vacuum sweeper (no brooms or water spray) to remove deposited material. Then, test sections by pouring water from a five gallon bucket to ensure they work.



- ❖ Inspect the structural integrity of the pavement surface, looking for signs of surface deterioration, such as slumping, cracking, spalling or broken pavers. Replace or repair affected areas, as necessary.
- ❖ Check inlets, pretreatment cells and any flow diversion structures for sediment buildup and structural damage. Note if any sediment needs to be removed.
- ❖ Inspect the condition of the observation well and make sure it is still capped.
- ❖ Generally inspect any contributing drainage area for any controllable sources of sediment or erosion.

## GIP – 03 SECTION 12: COMMUNITY & ENVIRONMENTAL CONCERNS

**Compliance with the Americans with Disabilities Act (ADA).** Porous concrete and porous asphalt are generally considered to be ADA compliant. Interlocking concrete pavers are considered to be ADA compliant, if designers ensure that surface openings between pavers do not exceed 0.5 inch. However, some forms of interlocking pavers may not be suitable for handicapped parking spaces. Interlocking concrete pavers interspersed with other hardscape features (e.g., concrete walkways) *can* be used in creative designs to address ADA issues.

**Groundwater Protection.** While well-drained soils enhance the ability of permeable pavement to reduce stormwater runoff volumes, they may also increase the risk that stormwater pollutants might migrate into groundwater aquifers. Designers should avoid the use of infiltration-based permeable pavement in areas known to provide groundwater recharge to aquifers used for water supply. In these source water protection areas, designers should include liners and underdrains in large-scale permeable pavement applications (i.e., when the proposed surface area exceeds 10,000 square feet).

**Stormwater Hotspots.** Designers should also certify that the proposed permeable pavement area will not accept any runoff from a severe stormwater hotspot. Stormwater hotspots are operations or activities that are known to produce higher concentrations of stormwater pollutants and/or have a greater risk of spills, leaks or illicit discharges. Examples include certain industrial activities, gas stations, public works areas and petroleum storage areas (for a complete list of hotspots where infiltration is restricted or prohibited, see Section 11.1 of **GIP-01 Bioretention**). For potential hotspots, restricted infiltration means that a minimum of 50% of the total  $T_v$  must be treated by a filtering or bioretention practice prior to the permeable pavement system. For known severe hotspots, the risk of groundwater contamination from spills, leaks or discharges is so great that infiltration of stormwater or snowmelt through permeable pavement is *prohibited*.

**Underground Injection Control Permits.** The Safe Drinking Water Act regulates the infiltration of stormwater in certain situations pursuant to the Underground Injection Control (UIC) Program, which is administered either by the EPA or a delegated state groundwater protection agency. In general, the EPA (2008) has determined that permeable pavement installations are not classified as Class V injection wells, since they are always wider than they are deep.

**Air and Runoff Temperature.** Permeable pavement appears to have some value in reducing summer runoff temperatures, which can be important in watersheds with sensitive cold-water fish populations. The temperature reduction effect is greatest when runoff is infiltrated into the sub-base, but some cooling may also occur in the reservoir layer, when underdrains are used. ICPI (2008) notes that the use of certain reflective colors for interlocking concrete pavers can also help moderate surface parking lot temperatures.





**Vehicle Safety.** Permeable pavement is generally considered to be a safer surface than conventional pavement, according to research reported by Smith (2006) and Jackson (2007). Permeable pavement has less risk of hydroplaning, more rapid ice melt and better traction than conventional pavement.

## GIP – 03 SECTION 13: REFERENCES

AG-588-14. North Carolina State University. Raleigh, NC. Available online at: [http://www.bae.ncsu.edu/stormwater/PublicationFiles/Perm Pave2008.pdf](http://www.bae.ncsu.edu/stormwater/PublicationFiles/Perm%20Pave2008.pdf).

American Society for Testing and Materials (ASTM). 2003. "Standard Classification for Sizes of Aggregate for Road and Bridge Construction." *ASTM D448-03a*. West Conshohocken, PA.

Chesapeake Stormwater Network (CSN). 2009. Technical Bulletin No. 1. *Stormwater Design Guidelines for Karst Terrain in the Chesapeake Bay watershed. Version 2.0*. Baltimore, MD. Available online at: <http://www.chesapeakestormwater.net/all-things-stormwater/stormwater-guidance-for-karst-terrain-in-the-chesapeake-bay.html>

City of Franklin, Stormwater Management Program, January 2014. *City of Franklin Stormwater Best Management Practices Manual*.

CWP. 2007. *National Pollutant Removal Performance Database, Version 3.0*. Center for Watershed Protection, Ellicott City, MD.

Hathaway, J. and W. Hunt. 2007. *Stormwater BMP Costs*. Report to NC DEHNR. Department of Biological and Agricultural Engineering. North Carolina State University. Raleigh, NC.

Hirschman, D., L. Woodworth and S. Drescher. 2009. *Technical Report: Stormwater BMPs in Virginia's James River Basin: An Assessment of Field Conditions & Programs*. Center for Watershed Protection. Ellicott City, MD.

Hunt, W. and K. Collins. 2008. "Permeable Pavement: Research Update and Design Implications." *North Carolina Cooperative Extension Service Bulletin*. Urban Waterways Series.

Interlocking Concrete Pavement Institute (ICPI). 2008. *Permeable Interlocking Concrete Pavement: A Comparison Guide to Porous Asphalt and Pervious Concrete*.

Jackson, N. 2007. *Design, Construction and Maintenance Guide for Porous Asphalt Pavements*. National Asphalt Pavement Association. Information Series 131. Lanham, MD. Available online at: [www.hotmix.com](http://www.hotmix.com)

Northern Virginia Regional Commission (NVRC). 2007. *Low Impact Development Supplement to the Northern Virginia BMP Handbook*. Fairfax, Virginia

Sustainable Infrastructure Alternative Paving Materials Subcommittee Report. Portland, Oregon. Available online at: <http://www.portlandonline.com/bes/index.cfm?c=34602&>

Schueler, T., C. Swann, T. Wright and S. Sprinkle. 2004. *Pollution source control practices*. Manual No. 8 in the Urban Subwatershed Restoration Manual Series. Center for Watershed Protection. Ellicott City, MD.



Schueler et al 2007. *Urban Stormwater Retrofit Practices*. Manual 3 in the Urban Subwatershed Restoration Manual Series. Center for Watershed Protection. Ellicott City, MD.

Schueler, T. 2008. Technical Support for the Baywide Runoff Reduction Method. Chesapeake Stormwater Network. Baltimore, MD. [www.chesapeakestormwater.net](http://www.chesapeakestormwater.net)

Smith, D. 2006. *Permeable Interlocking Concrete Pavement-selection design, construction and maintenance. Third Edition*. Interlocking Concrete Pavement Institute. Herndon, VA.

TDOT. 2010. *Roadway Design Guidelines*. Tennessee Department of Transportation, Nashville, TN. [http://www.tdot.state.tn.us/Chief\\_Engineer/assistant\\_engineer\\_design/design/DesGuide.htm](http://www.tdot.state.tn.us/Chief_Engineer/assistant_engineer_design/design/DesGuide.htm).

U.S EPA. 2008. June 13 2008 Memo. L. Boornaizian and S. Heare. "Clarification on which stormwater infiltration practices/technologies have the potential to be regulated as "Class V" wells by the Underground Injection Control Program." Water Permits Division and Drinking Water Protection Division. Washington, D.C.

VADCR. 2011. Stormwater Design Specification No. 7: Permeable Pavement, version 1.8, March 1, 2011. Virginia Department of Conservation and Recreation. <http://vwrrc.vt.edu/swc/NonProprietaryBMPs.html>.

Water Environment Research Federation (WERF). 2005. *Performance and Whole-life Costs of Best Management Practices and Sustainable Urban Drainage Systems*. Alexandria, VA.



## GIP-03 APPENDIX A INFILTRATION SOIL TESTING PROCEDURES

### I. Test Pit/Boring Procedures

1. The number of required test pits or standard soil borings is based on proposed infiltration area:
  - $< 1,000 \text{ ft}^2 = 2$  tests
  - $1,000 - 10,000 \text{ ft}^2 = 4$  tests
  - $>10,000 \text{ ft}^2 = 4$  tests + 1 test for every additional  $5,000 \text{ ft}^2$
2. **The location of each test pit or standard soil boring should correspond to the location of the proposed infiltration area.**
3. Excavate each test pit or penetrate each standard soil boring to a depth at least 2 feet below the bottom of the proposed infiltration area.
4. If the groundwater table is located within 2 feet of the bottom of the proposed facility, determine the depth to the groundwater table immediately upon excavation and again 24 hours after excavation is completed.
5. Determine the USDA or Unified Soil Classification system textures at the bottom of the proposed infiltration area and at a depth that is 2 feet below the bottom. All soil horizons should be classified and described.
6. If bedrock is located within 2 feet of the bottom of the proposed infiltration area, determine the depth to the bedrock layer.
7. Test pit/soil boring stakes should be left in the field to identify where soil investigations were performed.

### II. Infiltration Testing Procedures

1. The number of required infiltration tests is based on proposed infiltration area:
  - $< 1,000 \text{ ft}^2 = 2$  tests
  - $1,000 - 10,000 \text{ ft}^2 = 4$  tests
  - $>10,000 \text{ ft}^2 = 4$  tests + 1 test for every additional  $5,000 \text{ ft}^2$
2. **The location of each infiltration test should correspond to the location of the proposed infiltration area.**
3. Install a test casing (e.g., a rigid, 4 to 6 inch diameter pipe) to a depth 2 feet below the bottom of the proposed infiltration area.
4. Remove all loose material from the sides of the test casing and any smeared soil material from the bottom of the test casing to provide a natural soil interface into which water may percolate. If desired, a 2-inch layer of coarse sand or fine gravel may be placed at the bottom of the test casing to prevent clogging and scouring of the underlying soils. Fill the test casing with clean water to a depth of 2 feet, and allow the underlying soils to presoak for 24 hours.
5. After 24 hours, refill the test casing with another 2 feet of clean water and measure the drop in water level within the test casing after one hour. Repeat the procedure three (3) additional times by filling the test casing with clean water and measuring the drop in water level after one hour. A total of four (4) observations must be completed. The infiltration rate of the underlying soils may be reported either as the average of all four observations or the value of the last observation. The infiltration rate should be reported in terms of inches per hour.





6. Infiltration testing may be performed within an open test pit or a standard soil boring.
7. After infiltration testing is completed, the test casing should be removed and the test pit or soil boring should be backfilled and restored.



## Infiltration Trench



**Description:** Excavated trench filled with stone aggregate used to capture and allow infiltration of stormwater runoff into the surrounding soils from the bottom and sides of the trench. Runoff from each rain event is captured and treated primarily through settling and filtration.

## GIP - 04

### Hamilton County



### Water Quality Program

#### Components:

- Soil infiltration rate of 0.5 in/hr. or greater required
- Excavated trench (3 to 8 foot depth) filled with stone media (1.5- to 2.5-inch diameter); pea gravel and sand filter layers
- A sediment forebay and grass channel, or equivalent upstream pretreatment, must be provided
- Observation well to monitor percolation

#### Advantages/Benefits:

- Provides for groundwater recharge
- Good for small sites with porous soils
- Cost effective
- High community acceptance when integrated into a development

#### Disadvantages/Limitations:

- Potential for groundwater contamination
- High clogging potential; should not be used on sites with fine-particle soils (clays or silts) in drainage area
- Cannot be used in karst soils
- Geotechnical testing required
- Community perceived concerns with mosquitoes and safety

#### Design considerations:

- 5 acres maximum drainage area
- Space Required – Varies depending on the depth of the facility
- Site Slope – No more than 6% slope (for pre-construction facility footprint)
- Minimum Depth to Water Table – 4 feet recommended between the bottom of the infiltration trench and the elevation of the seasonally high water table

#### Selection Criteria:

**Level 1 – 50% Runoff Reduction Credit**

**Level 2 – 90% Runoff Reduction Credit**

#### Land Use Considerations:

- Residential
- Commercial
- Industrial (with approval)

#### Maintenance:

- Inspect for clogging
- Remove sediment from forebay
- Replace pea gravel layer as needed
- Maintain side slopes/remove invasive vegetation

**Maintenance Burden**  
 L = Low M = Moderate H = High

**H**



## GIP -04 SECTION 1: DESCRIPTION

Infiltration trenches are excavations typically filled with stone to create an underground reservoir for stormwater runoff (see Figure 4.1). The runoff volume gradually exfiltrates through the bottom and sides of the trench into the subsoil over a 2-day period and eventually reaches the water table. By diverting runoff into the soil, an infiltration trench not only treats the water quality volume, but also helps to preserve the natural water balance on a site and can recharge groundwater and preserve base flow. Due to this fact, infiltration systems are limited to areas with highly porous soils where the water table and/or bedrock are located well below the bottom of the trench.

In addition, infiltration trenches must be carefully sited to avoid the potential of groundwater contamination. Infiltration trenches are not intended to trap sediment and must always be designed with a sediment forebay and grass channel or filter strip or other appropriate pretreatment measures to prevent clogging and failure. Due to their high potential for failure, these facilities must only be considered for sites where upstream sediment control can be ensured.

Using the natural filtering properties of soil, infiltration trenches can remove a wide variety of pollutants from stormwater through sorption, precipitation, filtering, and bacterial and chemical degradation. Sediment load and other suspended solids should be removed from runoff by pretreatment measures on-site before they reach the trench surface.

## GIP – 04 SECTION 2: PERFORMANCE

When used appropriately, infiltration has a very high runoff volume reduction capability, as shown in **Table GIP-04-01**.

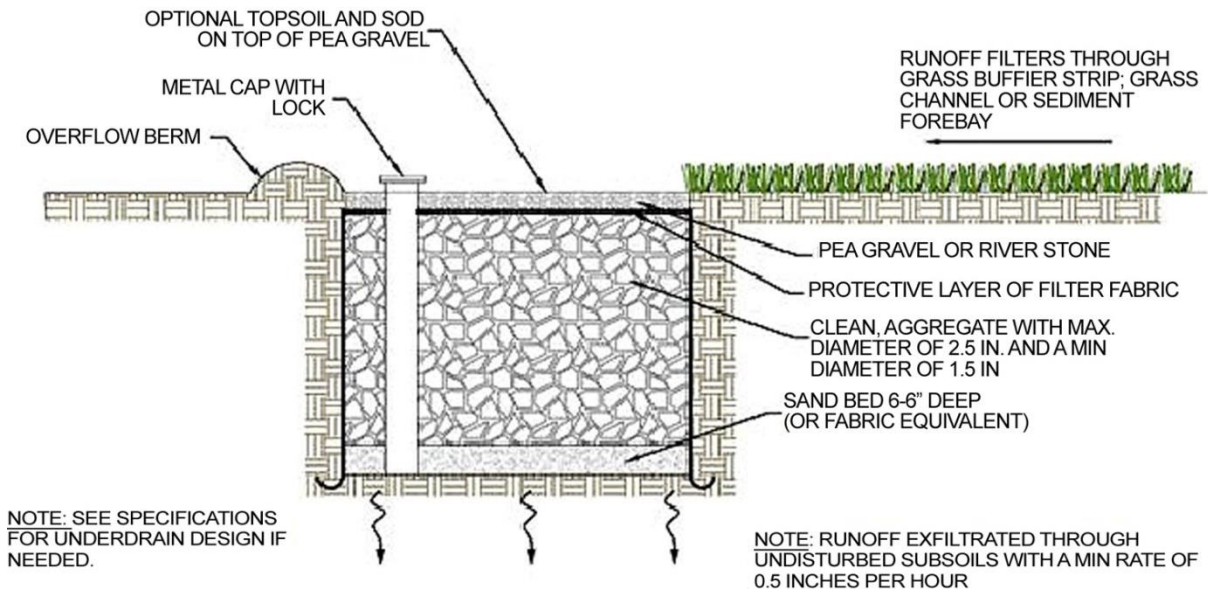
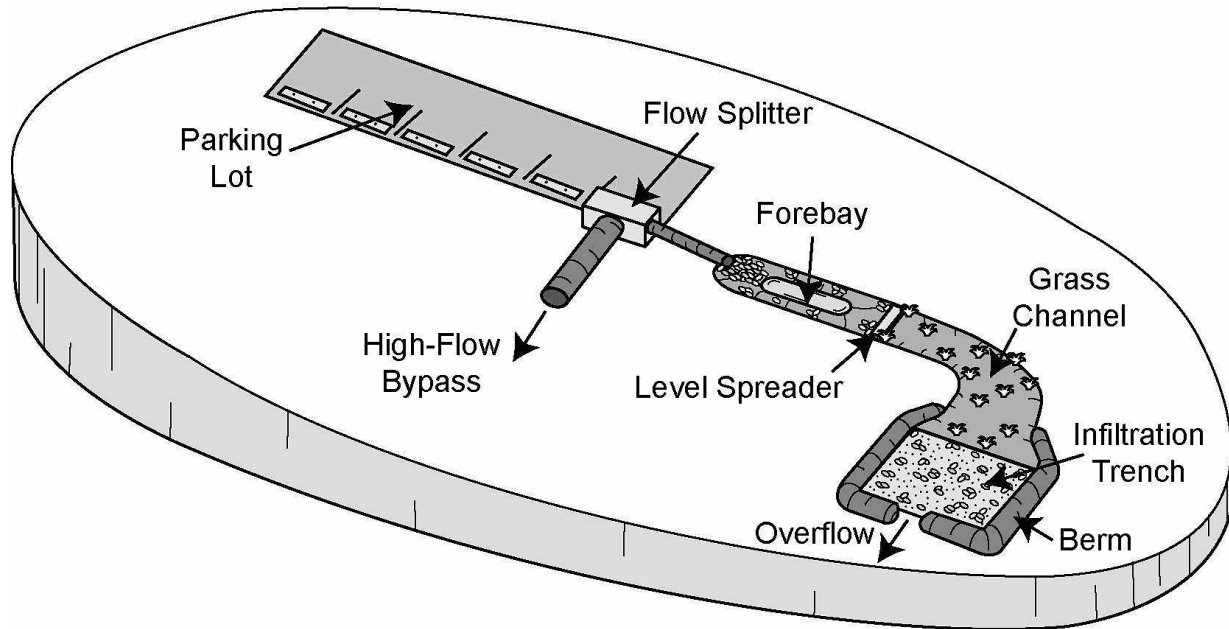
Stormwater Function	Level 1 Design	Level 2 Design
Runoff Volume Reduction (RR)	50%	90%

<sup>1</sup> CSN (2008) and CWP (2007)





**SECTION 3: TYPICAL DETAILS**



**Figure GIP-04-01. Infiltration Plan and Section (VADCR, 2011)**

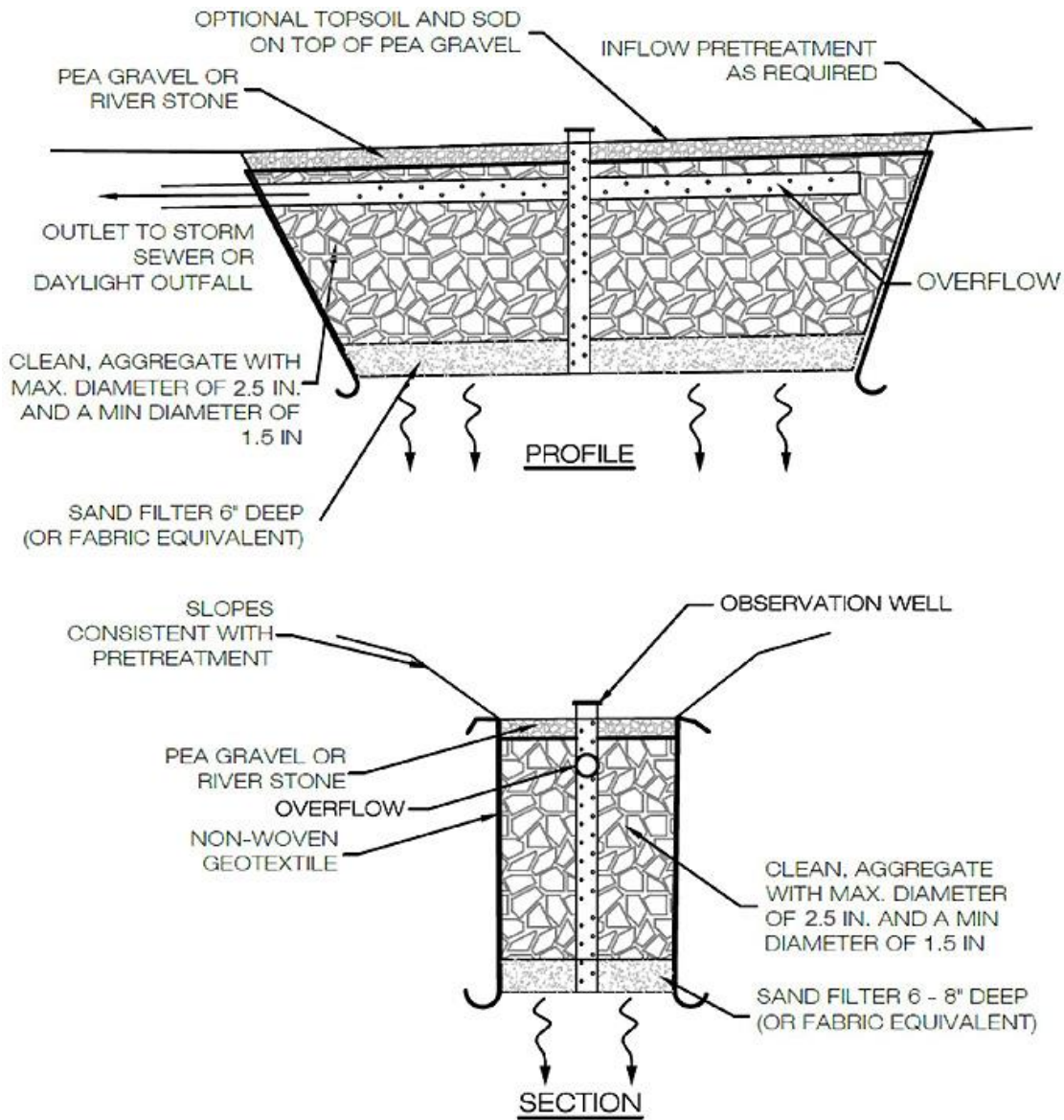


Figure GIP-04-02. Typical Infiltration Trench (VADCR, 2011)

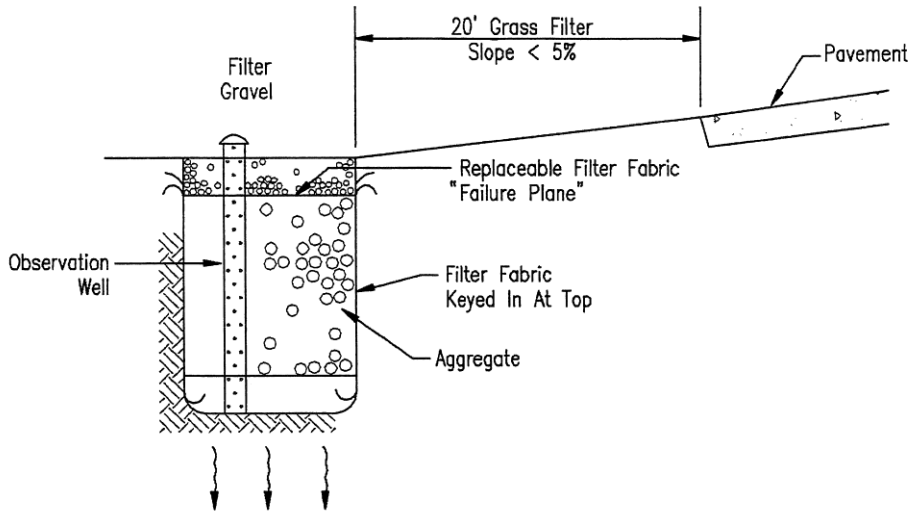


Figure GIP-04-03. Infiltration Trench Section (VADCR, 2011)

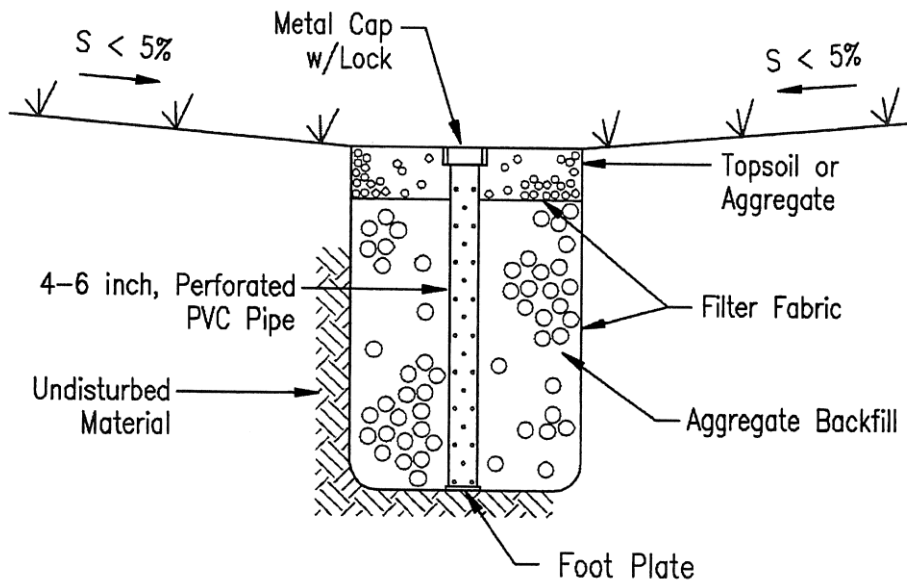


Figure GIP-04-04. Observation Well Detail (VADCR, 2011)





## GIP – 04 SECTION 4: DESIGN CRITERIA

### 4.1 Overview

Infiltration trenches are generally suited for medium-to-high density residential, commercial and institutional developments where the subsoil is sufficiently permeable to provide a reasonable infiltration rate and the water table is low enough to prevent groundwater contamination. They are applicable primarily for impervious areas where there are not high levels of fine particulates (clay/silt soils) in the runoff and should only be considered for sites where the sediment load is relatively low.

Infiltration trenches can either be used to capture sheet flow from a drainage area or function as an off-line device. Due to the relatively narrow shape, infiltration trenches can be adapted to many different types of sites and can be utilized in retrofit situations. Unlike some other structural stormwater controls, they can easily fit into the margin, perimeter, or other unused areas of developed sites.

To protect groundwater from potential contamination, runoff from designated hotspot land uses or activities must not be infiltrated. Infiltration trenches should not be used for manufacturing and industrial yards, where there is a potential for high concentrations of soluble pollutants and heavy metals. In addition, infiltration should not be considered for areas with a high pesticide concentration. Infiltration trenches are also not suitable in areas with karst geology without adequate geotechnical testing by qualified individuals and in accordance with **Appendix GIP-04-A**.

- ❖ To be suitable for infiltration, underlying soils should have an infiltration rate of greater than 0.5 inches per hour, as initially determined from NRCS soil textural classification and subsequently confirmed by field geotechnical tests. The minimum geotechnical testing is one test hole per 50 linear feet, with a minimum of two borings per facility (taken within the proposed limits of the facility). Infiltration trenches cannot be used in fill soils.
- ❖ Infiltration trenches should have a contributing drainage area of 5 acres or less.
- ❖ Soils in the drainage area tributary to an infiltration trench should have a clay content of less than 20% and a silt/clay content of less than 40% to prevent clogging and failure.
- ❖ There should be at least 2 feet between the bottom of the infiltration trench and the elevation of the seasonally high water table.
- ❖ Clay lenses, bedrock or other restrictive layers below the bottom of the trench will reduce infiltration rates unless excavated.
- ❖ Suggested minimum setback requirements for infiltration trench facilities:
  - From a property line – 10 feet
  - From a building foundation – 25 feet
  - From a private well – 100 feet
  - From a public water supply well – 1,200 feet
  - From a septic system tank/leach field – 100 feet
  - From surface waters – 100 feet
  - From surface drinking water sources – 400 feet (100 feet for a tributary)



- ❖ When used in an off-line configuration, the storage volume ( $T_v$ ) is diverted to the infiltration trench through the use of a flow splitter. Stormwater flows greater than the  $T_v$  are diverted to other controls or downstream using a diversion structure or flow splitter.
- ❖ To reduce the potential for costly maintenance and/or system reconstruction, it is strongly recommended that the trench be located in an open or lawn area, with the top of the structure as close to the ground surface as possible. Infiltration trenches shall not be located beneath paved surfaces, such as parking lots.
- ❖ Infiltration trenches are designed for intermittent flow and must be allowed to drain and allow aeration of the surrounding soil between rainfall events. They must not be used on sites with a continuous flow from groundwater, sump pumps, or other sources.

The major design goal for infiltration is to maximize runoff volume reduction. To this end, designers may choose to go with the baseline design (Level 1) or choose an enhanced design (Level 2) that maximizes runoff reduction. To qualify for Level 2, the infiltration practice must meet all the design criteria shown in the right hand column of **Table GIP-04-02**.

Table GIP-04-02. Level 1 and Level 2 Infiltration Design Guidelines	
Level 1 Design (RR:50)	Level 2 Design (RR:90)
Sizing: $T_v = [1(R_v)(A)/12]$ – the volume reduced by an upstream BMP	Sizing: $T_v = [1.1(R_v)(A)/12]$ – the volume reduced by an upstream BMP
At least two forms of pre-treatment (see <b>Table 4.3</b> )	At least three forms of pre-treatment (see <b>Table 4.3</b> )
Soil infiltration rate > 0.5 in/hr & <1 in/hr 1 test hole/50 linear ft., minimum of 2 (see <b>Appendix 4-A</b> )	Soil infiltration rates of 1.0 to 4.0 in/hr 1 test hole/50 linear ft., minimum of 2 (see <b>Appendix 4-A</b> )
Minimum of 2 feet between the bottom of the infiltration practice and the seasonal high water table or bedrock ( <b>Section 4.1</b> )	
$T_v$ infiltrates within 48 hours ( <b>Section 4.3</b> )	
Setbacks – see suggested minimum setbacks ( <b>Section 4.1</b> )	
<b>All Designs</b> are subject to hotspot runoff restrictions/prohibitions	

### 1.2 General Design

A well-designed infiltration trench consists of:

- ❖ Excavated shallow trench backfilled with sand, coarse stone, and pea gravel, and lined with a filter fabric;
- ❖ Appropriate pretreatment measures; and
- ❖ One or more observation wells to show how quickly the trench dewater or to determine if the device is clogged.

### 1.3 Physical Specifications/Geometry

- ❖ The required storage volume in the gravel trench is equal to the water quality volume ( $T_v$ ).
- ❖ A trench must be designed to fully dewater the entire  $T_v$  within 24 to 48 hours after a rainfall event. The slowest infiltration rate obtained from tests performed at the site should be used in the design calculations.
- ❖ Trench depths should be between 3 and 8 feet, to provide for easier maintenance. The width of a trench must be less than 25 feet.
- ❖ Broader, shallow trenches reduce the risk of clogging by spreading the flow over a larger area for infiltration.



- ❖ The surface area required is calculated based on the trench depth, soil infiltration rate, aggregate void space, and fill time (assume a fill time of 2 hours for most designs).
- ❖ The bottom slope of a trench should be flat across its length and width to evenly distribute flows, encourage uniform infiltration through the bottom, and reduce the risk of clogging.
- ❖ The stone aggregate used in the trench should be washed, bank-run gravel, 1.5 to 2.5 inches in diameter with porosity of about 40%. Aggregate contaminated with soil shall not be used. A porosity value (pore volume/total volume) of 0.32 should be used in calculations, unless aggregate specific data exist.
- ❖ A 6-inch layer of clean, washed sand is placed on the bottom of the trench to encourage drainage and prevent compaction of the native soil while the stone aggregate is added.
- ❖ The infiltration trench is lined on the sides and top by an appropriate geotextile filter fabric that prevents soil piping but has greater permeability than the parent soil. The top layer of filter fabric is located 2 to 6 inches from the top of the trench and serves to prevent sediment from passing into the stone aggregate. Since this top layer serves as a sediment barrier, it will need to be replaced more frequently and must be readily separated from the side sections.
- ❖ The top surface of the infiltration trench above the filter fabric is typically covered with pea gravel. The pea gravel layer improves sediment filtering and maximizes the pollutant removal in the top of the trench. In addition, it can easily be removed and replaced should the device begin to clog. Alternatively, the trench can be covered with permeable topsoil and planted with grass in a landscaped area.
- ❖ An observation well must be installed in every infiltration trench and should consist of a perforated PVC or HDPE pipe, 4 to 6 inches in diameter, extending to the bottom of the trench (see Figure 4.4 for a schematic of an observation well). The observation well will show the rate of dewatering after a storm, as well as provide a means of determining sediment levels at the bottom and when the filter fabric at the top is clogged and maintenance is needed. It should be installed along the centerline of the structure, flush with the ground elevation of the trench. A visible floating marker should be provided to indicate the water level. The top of the well should be capped and locked to discourage vandalism and tampering.
- ❖ The trench excavation should be limited to the width and depth specified in the design. Excavated material should be placed away from the open trench so as not to jeopardize the stability of the trench sidewalls. The bottom of the excavated trench shall not be loaded in a way that causes soil compaction, and should be scarified prior to placement of sand. The sides of the trench shall be trimmed of all large roots. The sidewalls shall be uniform with no voids and scarified prior to backfilling. All infiltration trench facilities should be protected during site construction and should be constructed after upstream areas have been stabilized.

#### 1.4 Pretreatment/Inlets

- ❖ Pretreatment facilities must always be used in conjunction with an infiltration trench to prevent clogging and failure
- ❖ For a trench receiving sheet flow from an adjacent drainage area, the pretreatment system should consist of a vegetated filter strip with a minimum 25-foot length. A vegetated buffer strip around the entire trench is required if the facility is receiving runoff from both directions. If the infiltration rate for the underlying soils is greater than 2 inches per hour, 50% of the  $T_v$  should be pretreated by another method prior to reaching the infiltration trench.
- ❖ For an off-line configuration, pretreatment should consist of a sediment forebay, vault, plunge pool, or similar sedimentation chamber (with energy dissipaters) sized to 25% of the storage volume ( $T_v$ ). Exit velocities from the pretreatment chamber must be nonerosive for the 2-year design storm.

Every infiltration practice must include multiple pretreatment techniques, although the nature of pretreatment practices depends on the scale at which infiltration is applied. The number, volume and type of acceptable pretreatment techniques needed for the two scales of infiltration are provided in **Table GIP-04-03**.





Table GIP-04-03. Required Pretreatment Elements for Infiltration Practices		
Pretreatment <sup>1</sup>	Scale of Infiltration	
	Small-Scale Infiltration	Conventional Infiltration
<b>Number and Volume of Pretreatment Techniques Employed</b>	<b>2</b> techniques; <b>15%</b> minimum pretreatment volume required (inclusive).	<b>3</b> techniques; <b>25%</b> minimum pretreatment volume required (inclusive); at least <b>one</b> separate pretreatment cell.
<b>Acceptable Pretreatment Techniques</b>	Grass filter strip Grass channel Plunge pool Gravel diaphragm	Sediment trap cell Sand filter cell Sump pit Grass filter strip Gravel diaphragm

<sup>1</sup> A minimum of 50% of the runoff reduction volume must be pre-treated by a filtering or bioretention practice *prior* to infiltration *if* the site is a restricted stormwater hotspot

### 1.5 Other Design Criteria

- ❖ **Outlet Structures.** Outlet structures are not required for infiltration trenches.
- ❖ **Emergency Spillway.** Typically for off-line designs, there is no need for an emergency spillway. However, a nonerosive overflow channel should be provided to safely pass flows that exceed the storage capacity of the trench to a stabilized downstream area or watercourse.
- ❖ **Maintenance Access.** Adequate access in an easement should be provided to an infiltration trench facility for inspection and maintenance.
- ❖ **Safety Features.** In general, infiltration trenches are not likely to pose a physical threat to the public and do not need to be fenced.
- ❖ **Landscaping.** Vegetated filter strips and buffers should fit into and blend with surrounding area. Native grasses are preferable, if compatible. The trench may be covered with permeable topsoil and planted with grass in a landscaped area.
- ❖ **Additional Site-Specific Design Criteria and Issues.** Not suitable for karst areas without adequate geotechnical testing.
- ❖ **Additional Permitting Requirements.** Underground Injection Control Permit (UIC) may be required from the State of Tennessee if the trench is deeper than its widest surface dimension.

## GIP – 04 SECTION 5: DESIGN PROCEDURES

**Step 1.** Compute the Storage Volume  $T_v$ .

Calculate the storage volume ( $T_v$ ). This volume must be contained in the gravel trench.

### Equation GIP-04-01. Treatment Volume

$$T_v = P \times R_v \times A / 12$$

Where:

- $T_v$  = Storage Volume, cu ft.
- $P$  = 1 in (Level 1) or 1.1 in (Level 2)
- $R_v$  = Runoff coefficient from RR Method (Section 2.3.3 of this manual)
- $A$  = Site area, sq. ft.



**Step 2.** Determine if the development site and conditions are appropriate for the use of an infiltration trench. Consider the Site and Design Considerations in this section, above.

**Step 3.** Divert flows above the  $T_v$  flow rate ( $Q_{TV}$ ).

Flows exceeding the  $T_v$  flow are to be diverted from the trench. Flows can be calculated using the Rational Method:

**Equation GIP-04-02. Rational Method for Treatment Volume Flow Rate**

$$Q_{TV} = CIA$$

Where:

- $Q_{TV}$  = The  $T_v$  flow rate
- $C$  = Runoff coefficient
- $I$  = Rainfall intensity for the design storm and a duration equal to the time of concentration
- $A$  = The contributing drainage area for the BMP, in acres

**Step 4.** Size flow diversion structure, if needed.

A flow regulator (or flow splitter diversion structure) should be supplied to divert the  $T_v$  to the infiltration trench.

Size low flow orifice, weir, or other device to pass  $Q_{TV}$ .

**Step 5.** Size infiltration trench.

The area of the trench can be determined from the following equation:

**Equation GIP-04-03. Surface Area for Infiltration Trench**

$$SA = \frac{T_v}{0.4(D)}$$

Where:

- $SA$  = Surface Area (sq. ft.)
- $T_v$  = Total volume to be infiltrated (cu. ft.)
- $D$  = Media depth of trench in feet.

All infiltration systems should be designed to fully dewater the entire  $T_v$  within 24 to 48 hours after the rainfall event. See the Physical Specifications/Geometry section of Site and Design Considerations for more details.

**Step 6.** Determine pretreatment volume and design pretreatment measures.

Size pretreatment facility to treat 25% of the water quality volume ( $T_v$ ) for offline configurations.

See the Pretreatment / Inlets (Section 4.3) for more details.

**Step 7.** Design spillway(s).

Adequate stormwater outfalls should be provided for the overflow exceeding the capacity of the trench, ensuring nonerosive velocities on the down-slope.



## GIP – 04 SECTION 6: AS-BUILT REQUIREMENTS

After the infiltration trench has been constructed, an as-built certification must be performed by a registered Professional Engineer and submitted to the Program. The as-built certification verifies that the BMP was installed as designed and approved.

The following components must be addressed in the as-built certification:

- ❖ The infiltration trench cannot be located in a sinkhole area or in karst soils.
- ❖ Infiltration rates must be verified.
- ❖ Proper dimensions for the trench must be verified.
- ❖ A mechanism for overflow for large storm events must be provided.

## GIP – 04 SECTION 7: MAINTENANCE

Each BMP must have a Hamilton County Water Quality Stormwater Management Facility I&M Storm Water Management Facilities Agreement submitted for approval and maintained and updated by the BMP owner. The Stormwater Management Facilities I&M Agreement must be completed and submitted to the Program with the Land Disturbance permit application. The Stormwater Management Facilities I&M Agreement is for the use of the BMP owner in performing routine inspections. The developer/owner is responsible for the cost of maintenance and annual inspections. The BMP owner must maintain and update the BMP inspections and maintenance plan. At a minimum, the inspections and maintenance plan must address:

- ❖ Ensure that contributing area, facility and inlets are clear of debris.
- ❖ Ensure that the contributing area is stabilized.
- ❖ Remove sediment and oil/grease from pretreatment devices, as well as overflow structures.
- ❖ Check observation wells following 3 days of dry weather. Failure to percolate within this time period indicates clogging.
- ❖ Inspect pretreatment devices and diversion structures for sediment build-up and structural damage.
- ❖ Remove trees that start to grow in the vicinity of the trench.
- ❖ Replace pea gravel/topsoil and top surface filter fabric (when clogged).
- ❖ Perform total rehabilitation of the trench to maintain design storage capacity.
- ❖ Excavate trench walls to expose clean soil.

## GIP – 04 SECTION 8: REFERENCES

Chesapeake Stormwater Network (CSN). 2008. *Technical Bulletin 1: Stormwater Design Guidelines for Karst Terrain in the Chesapeake Bay Watershed*. Version 1.0. Baltimore, MD. Available online at: <http://www.chesapeakestormwater.net/all-things-stormwater/stormwater-guidance-for-karst-terrain-in-the-chesapeake-bay.html>

CWP. 2007. *National Pollutant Removal Performance Database, Version 3.0*. Center for Watershed Protection, Ellicott City, MD.

ARC, 2001. *Georgia Stormwater Management Manual Volume 2 Technical Handbook*.





CDM, 2000. Metropolitan Nashville and Davidson County Stormwater Management Manual Volume 4 Best Management Practices.

City of Franklin, Stormwater Management Program. January 2014. *City of Franklin Stormwater Best Management Practices Manual*.

Federal Highway Administration (FHWA), United States Department of Transportation. Stormwater Best Management Practices in an Ultra-Urban Setting: Selection and Monitoring. Accessed January 2006. <http://www.fhwa.dot.gov/environment/ultraurb/index.htm>.

VADCR. 2011. Stormwater Design Specification No. 8: Infiltration, Version 1.9, March 1, 2011. Virginia Department of Conservation and Recreation. Available at: <http://vwrrc.vt.edu/swc/NonProprietaryBMPs.html>.



## GIP-04 APPENDIX A INFILTRATION SOIL TESTING PROCEDURES

### I. Test Pit/Boring Procedures

1. One test pit or standard soil boring should be provided for every 50 linear feet of the proposed infiltration trench, with a minimum of two per facility.
2. The location of each test pit or standard soil boring should correspond to the location of the proposed infiltration area.
3. Excavate each test pit or penetrate each standard soil boring to a depth at least 2 feet below the bottom of the proposed infiltration area.
4. If the groundwater table is located within 2 feet of the bottom of the proposed facility, determine the depth to the groundwater table immediately upon excavation and again 24 hours after excavation is completed.
5. Determine the USDA or Unified Soil Classification system textures at the bottom of the proposed infiltration area and at a depth that is 2 feet below the bottom. All soil horizons should be classified and described.
6. If bedrock is located within 2 feet of the bottom of the proposed infiltration area, determine the depth to the bedrock layer.
7. Test pit/soil boring stakes should be left in the field to identify where soil investigations were performed.

### II. Infiltration Testing Procedures

1. One infiltration test should be conducted for every 50 linear feet of infiltration trench, with a minimum of two per facility.
2. The location of each infiltration test should correspond to the location of the proposed infiltration area.
3. Install a test casing (e.g., a rigid, 4 to 6 inch diameter pipe) to a depth 2 feet below the bottom of the proposed infiltration area.
4. Remove all loose material from the sides of the test casing and any smeared soil material from the bottom of the test casing to provide a natural soil interface into which water may percolate. If desired, a 2-inch layer of coarse sand or fine gravel may be placed at the bottom of the test casing to prevent clogging and scouring of the underlying soils. Fill the test casing with clean water to a depth of 2 feet, and allow the underlying soils to presoak for 24 hours.
5. After 24 hours, refill the test casing with another 2 feet of clean water and measure the drop in water level within the test casing after one hour. Repeat the procedure three (3) additional times by filling the test casing with clean water and measuring the drop in water level after one hour. A total of four (4) observations must be completed. The infiltration rate of the underlying soils may be reported either as the average of all four observations or the value of the last observation. The infiltration rate should be reported in terms of inches per hour.
6. Infiltration testing may be performed within an open test pit or a standard soil boring. After infiltration testing is completed, the test casing should be removed and the test pit or soil boring should be backfilled and restored.



## Water Quality Swale



GIP - 05

Hamilton County



Water Quality Program

**Description:** Vegetated open channels designed to capture and infiltrate stormwater runoff within a dry storage layer beneath the base of the channel.

### Components:

- Open trapezoidal or parabolic channel to store entire treatment volume, which is ultimately infiltrated
- Filter bed of permeable, engineered soils
- Underdrain system for impermeable soils
- Level spreaders every 50 feet, if length exceeds 100 feet

### Advantages/Benefits:

- Stormwater treatment combined with conveyance
- Less expensive than curb and gutter
- Reduces runoff velocity
- Promotes infiltration

### Disadvantages/Limitations:

- Higher maintenance than curb and gutter
- Cannot be used on steep slopes
- High land requirement
- Requires 3 feet of head

### Design considerations:

- Longitudinal slopes ideally less than 2%
- Bottom channel width of 2 to 8 feet
- Underdrain required for subsoil infiltration rates less than 0.5 inches/hour
- Side slopes of 3:1 or flatter; 4:1 recommended
- Must convey the 10-year storm event with a minimum of 6 inches of freeboard

### Selection Criteria:

**Level 1 – 40% Runoff Reduction Credit**

**Level 2 – 60% Runoff Reduction Credit**

### Land Use Considerations:

- Residential
- Commercial
- Industrial (with approval)

### Maintenance:

- Maintain grass height (if turf)
- Remove sediment from forebay and channel
- Remove accumulated trash and debris
- Re-establish plants as needed

M

### Maintenance Burden

L = Low M = Moderate H = High





## GIP – 05 SECTION 1: DESCRIPTION

Water quality swales are essentially bioretention cells that are shallower, configured as linear channels, and covered with turf or other surface material (other than mulch and ornamental plants). The water quality swale is a soil and vegetative filter system that temporarily stores and then filters the desired Treatment Volume ( $T_v$ ). Water quality swales rely on a pre-mixed soil media filter below the channel that is similar to that used for bioretention. If soils are extremely permeable, runoff infiltrates into underlying soils. Otherwise, the runoff treated by the soil media flows into an underdrain, which conveys treated runoff back to the conveyance system further downstream. The underdrain system consists of a perforated pipe within a gravel layer on the bottom of the swale, beneath the filter media. Water quality swales may appear as simple grass channels with the same shape and turf cover, while others may have more elaborate landscaping. Swales can be planted with turf grass, tall meadow grasses, decorative herbaceous cover or trees.

## GIP – 05 SECTION 2: PERFORMANCE

The primary pollutant removal mechanisms operating in swales are settling, filtering infiltration and plant uptake. The overall runoff reduction capabilities of water quality swales are summarized in **Table GIP-05-01**.

Table GIP-05-01. Runoff Volume Reduction Provided by Water Quality Swales		
Stormwater Function	Level 1 Design	Level 2 Design
Runoff Volume Reduction (RR)	40%	60%

Sources: CSN (2008), CWP (2007)



## GIP – 05 SECTION 3: DESIGN TABLE

Swales can be oriented to accept runoff from a single discharge point, or to accept runoff as lateral sheet flow along the swale’s length.

Table GIP-05-02. Water Quality Swale Design Criteria	
Level 1 Design (RR:40)	Level 2 Design (RR:60)
Sizing: See GIP-05 <b>Section 6.1</b>	Sizing: See GIP-05 <b>Section 6.1</b>
Surface Area (sq. ft.) = $(Tv - \text{the volume reduced by an upstream BMP}) / \text{Storage depth}^1$	Surface Area sq. ft.) = $\{(1.1)(Tv) - \text{the volume reduced by an upstream BMP}\} / \text{Storage Depth}^1$
Effective swale slope $\leq 2\%$	Effective swale slope $\leq 1\%$
Media Depth: minimum = 18 inches;	Media Depth minimum = 24 inches
Recommended maximum = 36 inches	Recommended maximum = 36 inches
Sub-soil testing (GIP-05 <b>Section 6.2</b> ): one per 50 linear feet, 2 minimum; not needed if an underdrain is used; min. infiltration rate must be $> 0.5$ inch/hour to remove the underdrain requirement;	
Underdrain (GIP-05 <b>Section 6.7</b> ): Schedule 40 PVC or HDPE with clean-outs	Underdrain and Underground Storage Layer (GIP-05 <b>Section 6.7</b> ): Schedule 40 PVC or HDPE with clean outs, and a minimum 12-inch stone sump below the invert; OR none if the soil infiltration requirements are met (see GIP-05 <b>Section 6.2</b> )
Media (GIP-05 <b>Section 6.6</b> ): supplied by the vendor or mixed onsite <sup>2</sup>	
Inflow: sheet or concentrated flow with appropriate pre-treatment	
Pre-Treatment (GIP-05 <b>Section 6.4</b> ): a pretreatment cell, spreader, or another approved (manufactured) grass filter strip, gravel diaphragm, or gravel flow pre-treatment structure.	
On-line design	Off-line design or multiple treatment cells
Planting Plan: turf grass, tall meadow grasses, decorative herbaceous cover, or trees	

<sup>1</sup>The storage depth is the sum of the porosity (n) of the soil media and gravel layers multiplied by their respective depths, plus the surface ponding depth (Refer to GIP-05 **Section 6.1**)

<sup>2</sup> Refer to **GIP 01: Bioretention** for soil specifications





**Figure GIP-05-01. Turf Grass Water Quality Swale in commercial/office setting (source: VADCR, 2011)**



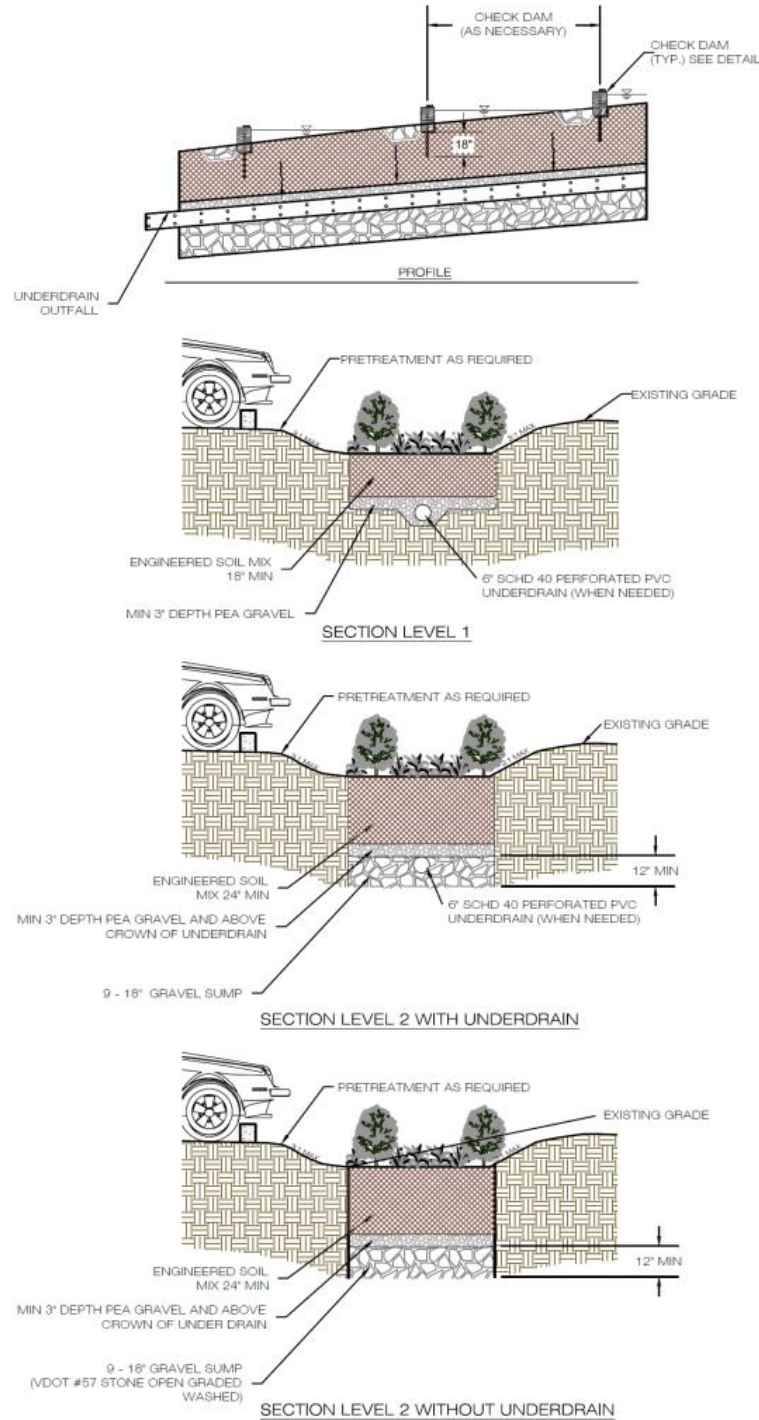
**Figure GIP-05-02. Water Quality Swale w/ tall meadow grasses & herbaceous plants along trail receiving runoff from parking area (source: National Transportation Enhancements Clearinghouse / [www.enhancements.org](http://www.enhancements.org))**





**GIP – 05 SECTION 4: TYPICAL DETAILS**

Figures GIP-05-03 through GIP-05-07 below provide typical schematics for water quality swales.



**Figure GIP-05-03. Typical Details for Level 1 and 2 Water Quality Swales (source: VADCR, 2011)**

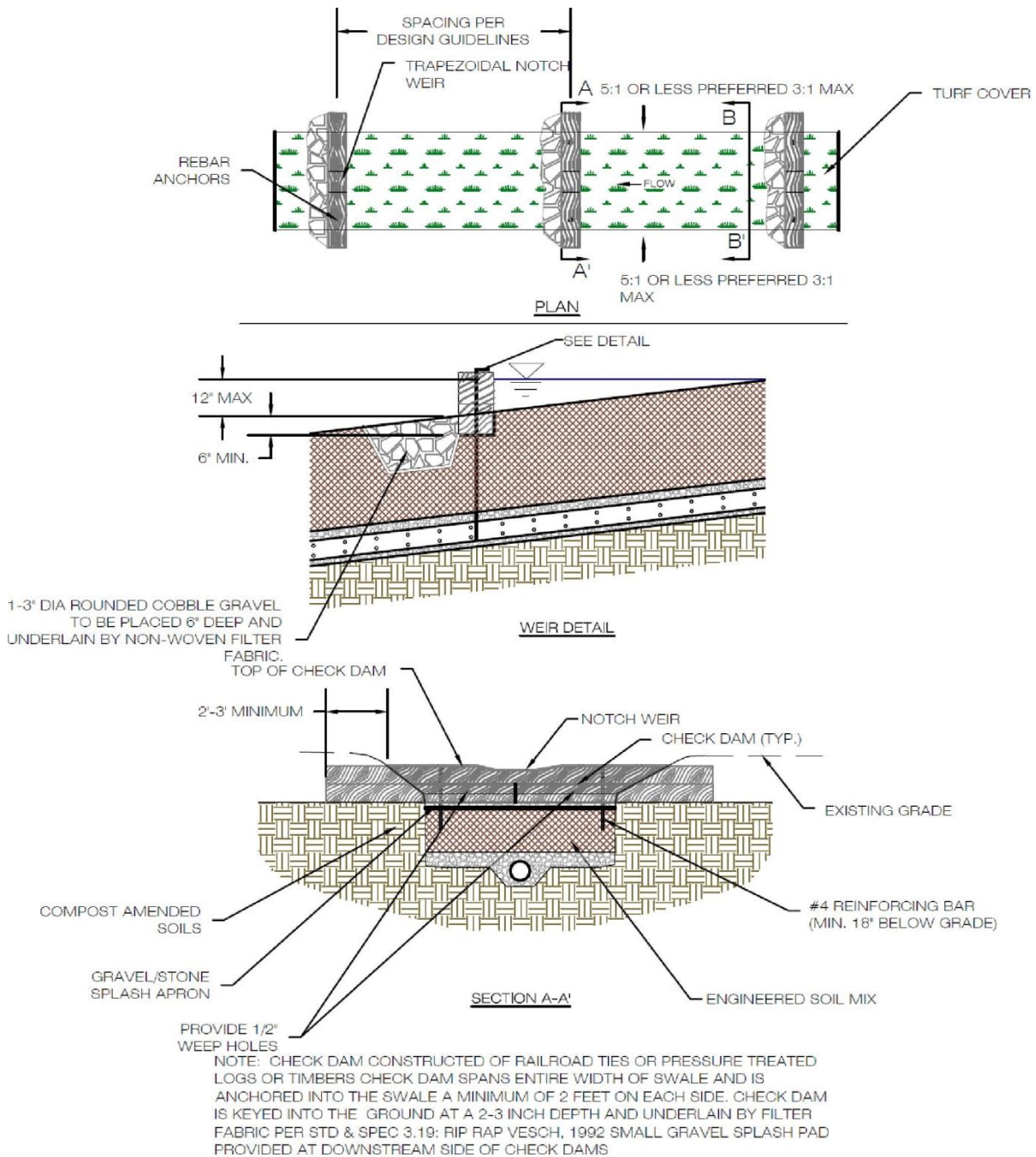


Figure GIP-05-04. Typical Detail for Water Quality Swale Check Dam (source: VADCR, 2011)



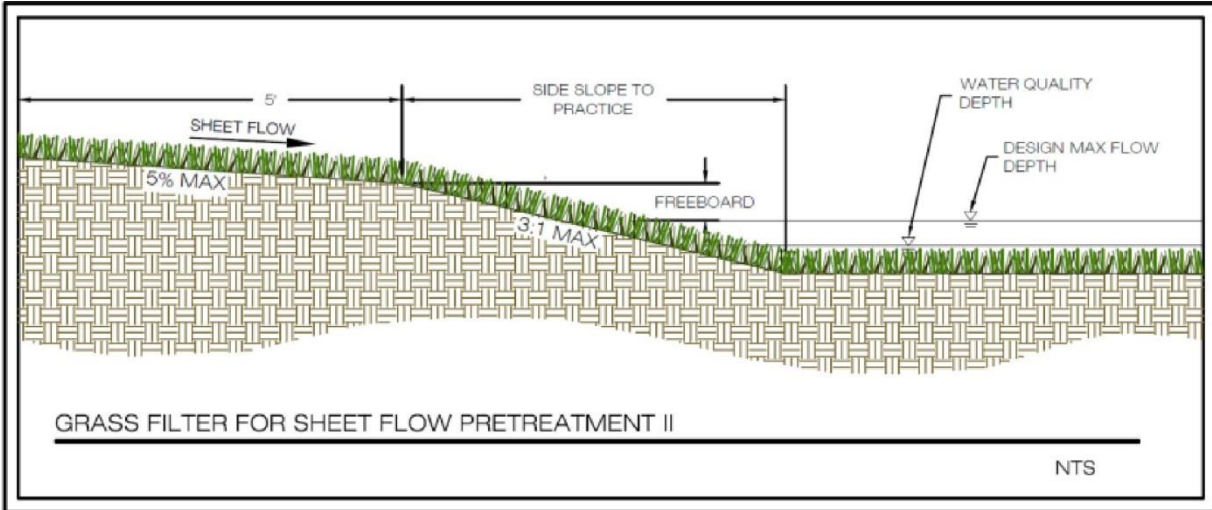
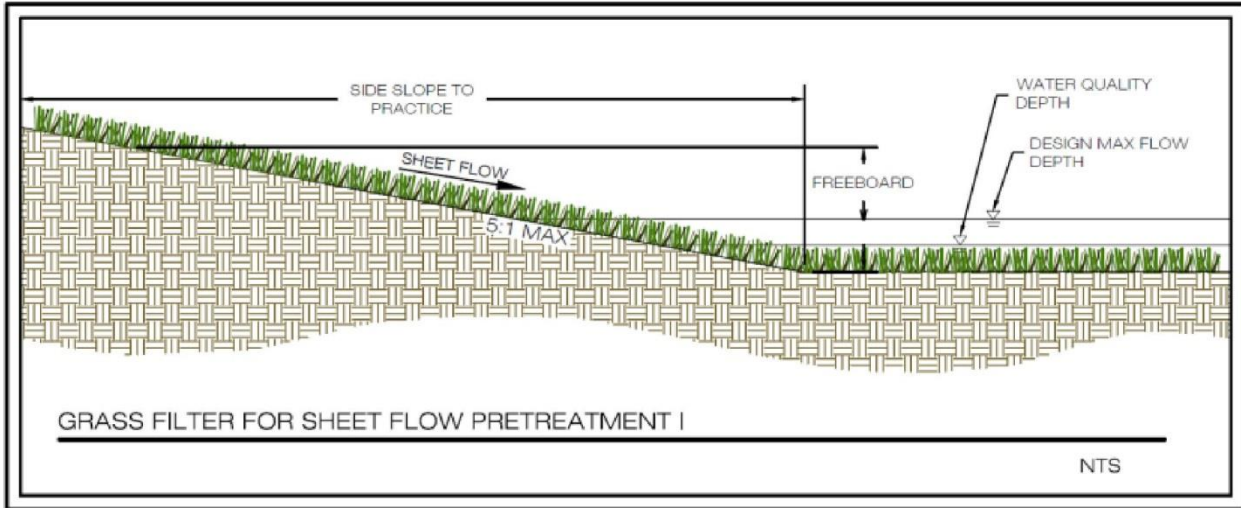


Figure GIP-05-05. Pretreatment I and II - Grass Filter for Sheet Flow (source: VADCR, 2011)

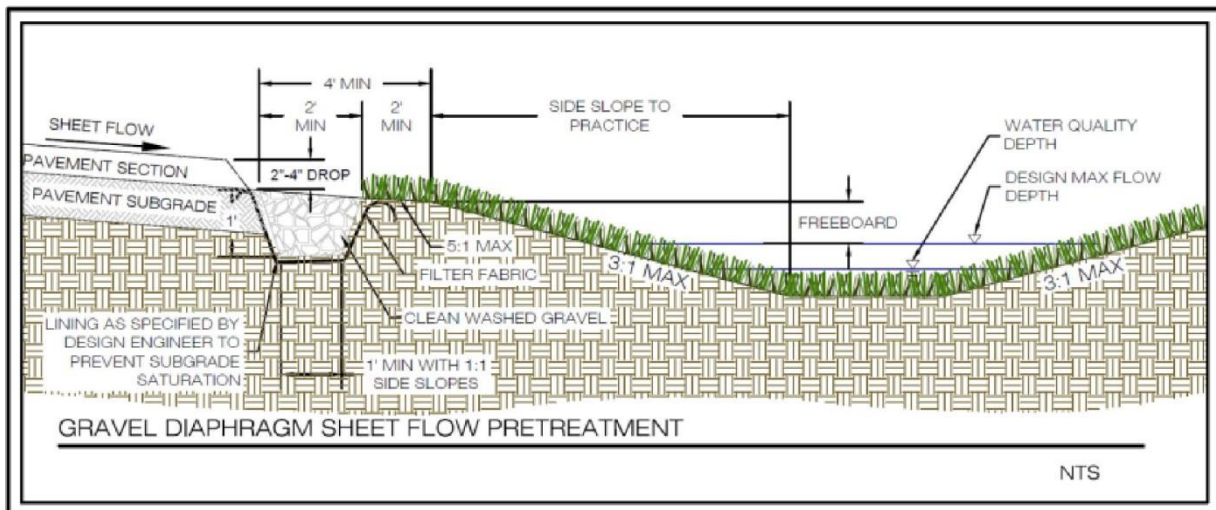


Figure GIP-05-06. Pretreatment – Gravel Diaphragm for Sheet Flow from Impervious or Pervious (source: VADCR, 2011)



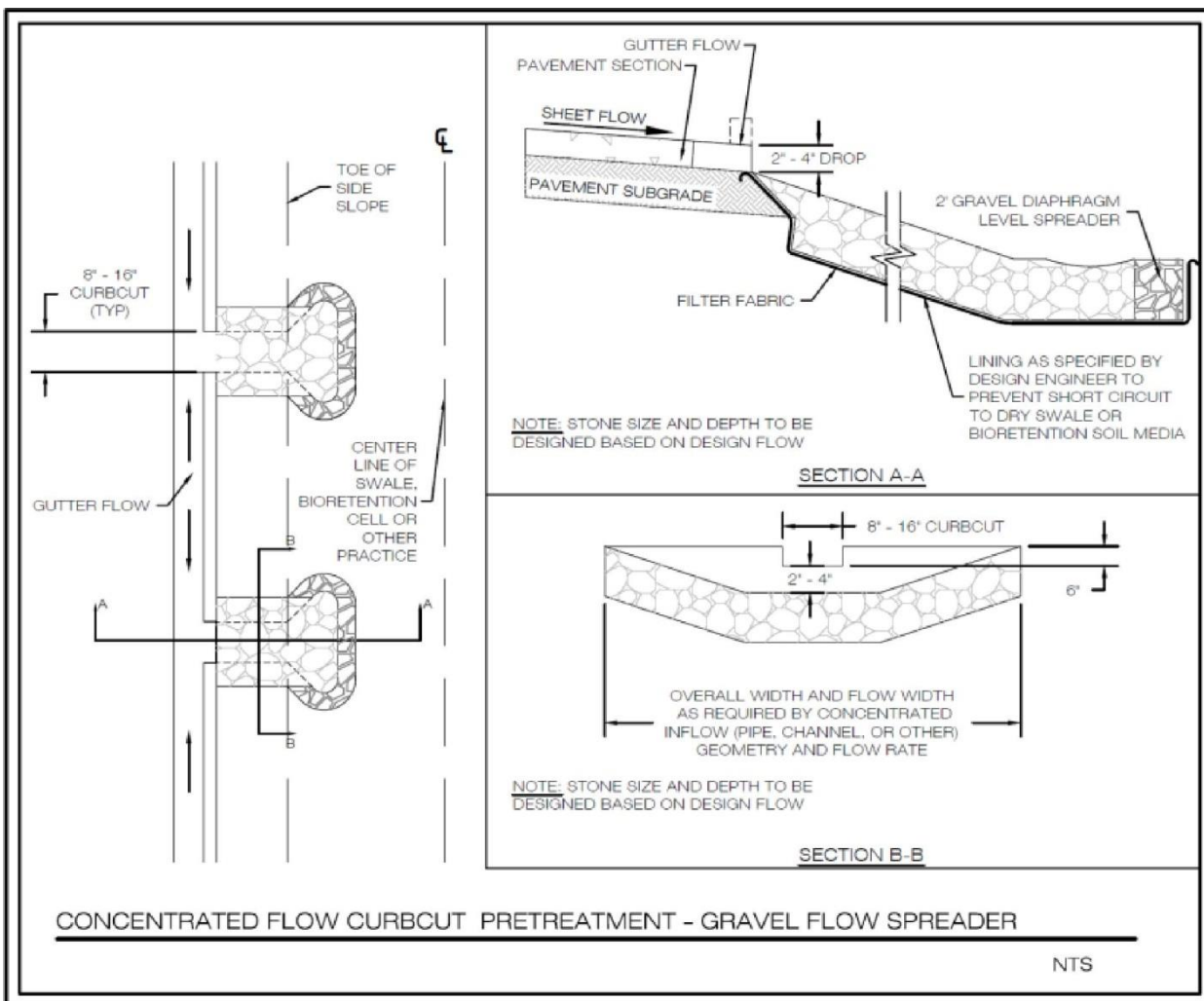


Figure GIP-05-07. Pre-Treatment – Gravel Flow Spreader for Concentrated Flow (source: VADCR, 2011)

## GIP – 05 SECTION 5: PHYSICAL FEASIBILITY & DESIGN APPLICATIONS

Water quality swales can be implemented on a variety of development sites where density and topography permit their application. Some key feasibility issues for water quality swales include the following:

**Contributing Drainage Area.** The maximum impervious contributing drainage area to a water quality swale should be 2.5 acres. When water quality swales treat larger drainage areas, the velocity of flow through the surface channel often becomes too great to treat runoff or prevent erosion in the channel. Similarly, the longitudinal flow of runoff through the soil, stone, and underdrain may cause hydraulic overloading at the downstream sections of the water quality swale. An alternative is to provide a series of inlets or diversions that convey the treated water to an outlet location.



**Available Space.** Water quality swale footprints can fit into relatively narrow corridors between utilities, roads, parking areas, or other site constraints. Water quality swales should be approximately 3% to 10% of the size of the contributing drainage area, depending on the amount of impervious cover.

**Site Topography.** Water quality swales should be used on sites with longitudinal slopes of less than 4%, but preferably less than 2%. Check dams can be used to reduce the effective slope of the swale and lengthen the contact time to enhance filtering and/or infiltration. Steeper slopes adjacent to the swale may generate rapid runoff velocities into the swale that may carry a high sediment loading (refer to pre-treatment criteria in **Section 6.4**).

**Available Hydraulic Head.** A minimum amount of hydraulic head is needed to implement water quality swales, measured as the difference in elevation between the inflow point and the downstream storm drain invert. Water quality swales typically require 3 feet of hydraulic head.

**Hydraulic Capacity.** Level 1 water quality swales are an on-line practice and must be designed with enough capacity to (1) convey runoff from the 100-year design storms at non-erosive velocities, and (2) contain the 10-year flow within the banks of the swale. This means that the swale's surface dimensions are more often determined by the need to pass the 10-year storm events, which can be a constraint in the siting of water quality swales within existing right of way (e.g., constrained by sidewalks).

**Depth to Water Table.** Designers should ensure that the bottom of the water quality swale is at least 2 feet above the seasonally high groundwater table, to ensure that groundwater does not intersect the filter bed, since this could lead to groundwater contamination or practice failure.

**Soils.** Soil conditions do not constrain the use of water quality swales, although they normally determine whether an underdrain is needed. Low-permeability soils with an infiltration rate of less than or equal to 0.5 inch per hour, such as those classified in Hydrologic Soil Groups (HSG) C and D, will require an underdrain. Designers must verify site-specific soil permeability at the proposed location using the methods for on-site soil investigation presented in **Appendix 5-A** in order to eliminate the requirements for an underdrain.

**Utilities.** Designers should consult local utility design guidance for the horizontal and vertical clearance between utilities and the swale configuration. Utilities can cross linear swales if they are specially protected (e.g., double-casing). Water and sewer lines generally need to be placed under road pavements to enable the use of water quality swales.

**Avoidance of Irrigation or Baseflow.** Water quality swales should be located so as to avoid inputs of springs, irrigation systems, chlorinated wash-water, or other dry weather flows.

**Setbacks from Building and Roads.** Given their landscape position, water quality swales are not subject to normal building setbacks. The bottom elevation of swales should be at least 1 foot below the invert of an adjacent road bed.

**Hotspot Land Use.** Runoff from hotspot land uses should not be treated with infiltrating water quality swales. An impermeable liner should be used for filtration of hotspot runoff.

**Community Acceptance.** The main concerns of adjacent residents are perceptions that swales will create nuisance conditions or will be hard to maintain. Common concerns include the continued ability to mow grass, landscape



preferences, weeds, standing water, and mosquitoes. Water quality swales are actually a positive stormwater management alternative, because all these concerns can be fully addressed through the design process and proper on-going inspection and routine maintenance. The ponding time is less than the time required for one mosquito breeding cycle, so well-maintained water quality swales should not create mosquito problems or be difficult to mow.

## GIP – 05 SECTION 6: DESIGN CRITERIA

### 6.1 Sizing of Water Quality Conveyance and Water Quality Treatment Swales

Sizing of the surface area (SA) for water quality swales is based on the computed Treatment Volume ( $T_v$ ) of the contributing drainage area and the storage provided within the swale media and gravel layers and behind check dams. The required surface area (in square feet) is computed as the Treatment Volume (in cubic feet) divided by the equivalent storage depth (in feet). The equivalent storage depth is computed as the depth of the soil media, the gravel, and surface ponding (in feet) multiplied by the accepted porosity.

The accepted porosities are:

Water Quality Swale Soil Media $n$	=	0.40
Gravel $n$	=	0.40
Surface Storage behind check dams $n$	=	1.0

The equivalent storage depth for the Level 1 design (without considering surface ponding) is therefore computed as:

#### **Equation GIP-05-01. Equivalent Storage Depth – Level 1**

$$\text{Equivalent Storage Depth} = D_E = n_1(D_1) + n_2(D_2) + \dots$$

$$D_E = (1.5 \text{ ft.} \times 0.40) + (0.25 \text{ ft.} \times 0.40) = 0.7 \text{ ft.}$$

And the equivalent storage depth for the Level 2 design (without considering surface ponding) is computed as:

#### **Equation GIP-05-02. Equivalent Storage Depth – Level 2**

$$D_E = (2.0 \text{ ft.} \times 0.40) + (1.0 \text{ ft.} \times 0.40) = 1.2 \text{ ft}$$

*The effective storage depths will vary according to the actual design depths of the soil media and gravel layer.*

**Note:** When using Equations 3 or 4 below to calculate the required surface area of a water quality swale that includes surface ponding (with check dams), the storage depth calculation (Equation 1 or 2) should be adjusted accordingly.

The Level 1 Water Quality Swale Surface Area (SA) is computed as:

#### **Equation GIP-05-03. Surface Area – Level 1**

$$SA \text{ (sq. ft.)} = (T_v - \text{the volume reduced by an upstream GIP}) / D_E \text{ ft.}$$





And the Level 2 Water Quality Swale SA is computed as:

**Equation GIP-05-04. Surface Area – Level 2**

$$SA \text{ (sq. ft.)} = [(1.1 * T_v) - \text{the volume reduced by an upstream GIP}] / D_E$$

NOTE: The volume reduced by upstream PTPs is supplemented with the anticipated volume of storage created by check dams along the swale length.

Where:

- SA = Minimum surface area of Water Quality Swale (sq. ft.)
- T<sub>v</sub> = Treatment Volume (cu. ft.) = [(1 inch)(R<sub>v</sub>)(A)]\*3630 , A= Area in acres

The final water quality swale design geometry will be determined by dividing the SA by the swale length to compute the required width; or by dividing the SA by the desired width to compute the required length.

**6.2 Soil Infiltration Rate Testing**

The second key sizing decision is to measure the infiltration rate of subsoils below the water quality swale area to determine if an underdrain will be needed. The infiltration rate of the subsoil must exceed 0.5 inches per hour to avoid installation of an underdrain. The acceptable methods for on-site soil infiltration rate testing are outlined in **Appendix 5-A**. A soil test should be conducted for every 50 linear feet of water quality swale, with a minimum of two tests per swale.

**6.3 Water Quality Swale Geometry**

Design guidance regarding the geometry and layout of water quality swales is provided below.

**Shape.** A parabolic shape is preferred for water quality swales for aesthetic, maintenance and hydraulic reasons. However, the design may be simplified with a trapezoidal cross-section, as long as the soil filter bed boundaries lay in the flat bottom areas.

**Side Slopes.** The side slopes of water quality swales should be no steeper than 3H:1V for maintenance considerations (i.e., mowing). Flatter slopes are encouraged where adequate space is available, to enhance pre-treatment of sheet flows entering the swale. Swales should have a bottom width of from 2 to 8 feet to ensure that an adequate surface area exists along the bottom of the swale for filtering. If a swale will be wider than 8 feet, the designer should incorporate berms, check dams, level spreaders or multi-level cross-sections to prevent braiding and erosion of the swale bottom.

**Swale Longitudinal Slope.** The longitudinal slope of the swale should be moderately flat to permit the temporary ponding of the Treatment Volume within the channel. The recommended swale slope is less than or equal to 2% for a Level 1 design and less than or equal to 1% for a Level 2 design, though slopes up to 4% are acceptable if check dams are used. The minimum recommended slope for an on-line water quality swale is 0.5%. Refer to **Table GIP-05-03** for check dam spacing based on the swale longitudinal slope.



**Table GIP-05-03. Typical Check Dam Spacing to Achieve Effective Swale Slope**

Swale Longitudinal Slope	LEVEL 1	LEVEL 2
	Spacing <sup>1</sup> of 12-inch High (max.) Check Dams <sup>2</sup> to Create an Effective Slope of 2%	Spacing <sup>1</sup> of 12-inch High (max.) Check Dams <sup>2</sup> to Create an Effective Slope of 0 to 1%
0.5%	–	200 ft. to –
1.0%	–	100 ft. to –
1.5%	–	67 ft. to 200 ft.
2.0%	–	50 ft. to 100 ft.
2.5%	200 ft.	40 ft. to 67 ft.
3.0%	100 ft.	33 ft. to 50 ft.
3.5%	67 ft.	30 ft. to 40 ft.
4.0%	50 ft.	25 ft. to 33 ft.

<sup>1</sup> The spacing dimension is half of the above distances if a 6-inch check dam is used.

<sup>2</sup> Check dams require a stone energy dissipater at the downstream toe.

**Check dams.** Check dams must be firmly anchored into the side-slopes to prevent outflanking and be stable during the 10 year storm design event. The height of the check dam relative to the normal channel elevation should not exceed 12 inches. Each check dam should have a minimum of one weep hole or a similar drainage feature so it can dewater after storms. Armoring may be needed behind the check dam to prevent erosion. The check dam must be designed to spread runoff evenly over the water quality swale’s filter bed surface, through a centrally located depression with a length equal to the filter bed width. In the center of the check dam, the depressed weir length should be checked for the depth of flow, sized for the appropriate design storm (see **Figure 5.4**). Check dams should be constructed of wood, stone, concrete or a material that withstands the design flow energy.

**Ponding Depth.** Drop structures or check dams can be used to create ponding cells along the length of the swale. The maximum ponding depth in a swale should not exceed 12 inches at the most downstream point.

**Drawdown.** Water quality swales should be designed so that the desired Treatment Volume is completely filtered within 24 hours or less. This drawdown time can be achieved by using the soil media mix specified in **Section 6.6** and an underdrain along the bottom of the swale, or native soils with adequate permeability, as verified through testing (see GIP-05 **Section 6.2**).

**Underdrain.** Underdrains are provided in water quality swales to ensure that they drain properly after storms (see GIP-05 **Section 6.7**). The underdrain should be constructed of 6-inch diameter perforated HDPE or PVC, which is placed on either a 3-inch layer of double-washed gravel (TDOT #57) for Level 1 or directly on a 12-inch sump layer of 1-inch stone for Level 2. The underdrain should be encased in a gravel layer extending at least 3 inches above the surface of the pipe. This gravel layer should be covered with a 3-inch layer of choker stone (TDOT #8 or #89), which is then covered with a permeable geotextile.

#### 6.4 Pre-treatment

Several pre-treatment measures are feasible, depending on whether the specific location in the water quality swale system will be receiving sheet flow, shallow concentrated flow, or fully concentrated flow:



- ❖ **Initial Sediment Forebay** (channel flow). This grass cell is located at the upper end of the water quality swale segment with a 2:1 length to width ratio and a storage volume equivalent to at least 15% of the total Treatment Volume.
- ❖ **Check dams** (channel flow). These energy dissipation devices are acceptable as pre-treatment on small swales with drainage areas of less than 1 acre.
- ❖ **Tree Check dams** (channel flow). These are street tree mounds that are placed within the bottom of a water quality swale up to an elevation of 9 to 12 inches above the channel invert. One side has a gravel or river stone bypass to allow storm runoff to percolate through.
- ❖ **Grass Filter Strip** (sheet flow). Grass filter strips extend from the edge of the pavement to the bottom of the water quality swale at a 5:1 slope or flatter. Alternatively, provide a combined 5 feet of grass filter strip at a maximum 5% (20:1) slope and 3:1 or flatter side slopes on the water quality swale. (See Figure 5.5)
- ❖ **Gravel Diaphragm** (sheet flow). A gravel diaphragm located at the edge of the pavement should be oriented perpendicular to the flow path to pre-treat lateral runoff, with a 2 to 4 inch drop. The stone must be sized according to the expected rate of discharge. (See Figure GIP-05-06)
- ❖ **Pea Gravel Flow Spreader** (concentrated flow). The gravel flow spreader is located at curb cuts, downspouts, or other concentrated inflow points, and should have a 2 to 4 inch elevation drop from a hard-edged surface into a gravel or stone diaphragm. The gravel should extend the entire width of the opening and create a level stone weir at the bottom or treatment elevation of the swale. (See Figure GIP-05-07)

### 6.5 Conveyance and Overflow

The bottom width and slope of a water quality swale should be designed such that the velocity of flow from a 1-inch rainfall will not exceed 3 feet per second. Check dams may be used to achieve the needed runoff reduction volume, as well as to reduce the flow. Check dams should be spaced based on channel slope and ponding requirements, consistent with the criteria in **Table GIP-05-03**.

The swale should also convey the 2- and 10-year storms at non-erosive velocities with at least 6 inches of freeboard. The analysis should evaluate the flow profile through the channel at normal depth, as well as the flow depth over top of the check dams.

Water quality swales may be designed as off-line systems, with a flow splitter or diversion to divert runoff in excess of the design capacity to an adjacent conveyance system. Or, strategically placed overflow inlets may be placed along the length of the swale to periodically pick up water and reduce the hydraulic loading at the downstream limits.

### 6.6 Filter Media

Water quality swales require replacement of native soils with a prepared soil media. The soil media provides adequate drainage, supports plant growth, and facilitates pollutant removal within the water quality swale. At least 18 inches of soil media should be added above the choker stone layer to create an acceptable filter. The mixture for the soil media is identical to that used for bioretention and is provided in **Table 5.4** (refer to GIP-01: Bioretention, for additional soil media specifications).

### 6.7 Underdrain and Underground Storage Layer

Some Level 2 water quality swale designs will not use an underdrain [(where soil infiltration rates meet minimum standards (see GIP-05 Section 6.2 and Table GIP-05-02)]. For Level 2 designs with an underdrain, an underground storage layer, consisting of a minimum 12 inches of stone, should be incorporated below the invert of the underdrain. The depth of the storage layer will depend on the target treatment and storage volumes needed to meet water quality criteria. However, the bottom of the storage layer must be at least 2 feet above the seasonally





high groundwater table and bedrock. The storage layer should consist of clean, washed #57 stone or an approved infiltration module.

A water quality swale should include observation wells with cleanout pipes along the length of the swale, if the contributing drainage area exceeds 1 acre. The wells should be tied into any T's or Y's in the underdrain system, and should extend upwards to be flush with surface, with a vented cap.

### 6.8 Landscaping and Planting Plan

Designers should choose grasses, herbaceous plants or trees that can withstand both wet and dry periods and relatively high velocity flows for planting within the channel. Salt tolerant grass species should be chosen for water quality swales receiving drainage from areas treated for ice in winter. Taller and denser grasses are preferable, although the species is less important than good stabilization and dense vegetative cover. Grass species should have the following characteristics: a deep root system to resist scouring; a high stem density with well-branched top growth; water-tolerance; resistance to being flattened by runoff; and an ability to recover growth following inundation. A qualified landscape designer should be consulted for selection of appropriate plantings.

### 6.9 Water Quality Swale Material Specifications

**Table GIP-05-04** outlines the standard material specifications for constructing water quality swales.

Table 5.4. Water Quality Swale Material Specifications		
Material	Specification	Notes
Filter Media Composition	Filter Media to contain (by volume): 30-70% sand < 40% silt 5-10% organic matter < 20% clay	The volume of filter media is based on 110% of the product of the surface area and the media depth, to account for settling.
Filter Media Testing	Mix on-site or procure from an approved media vendor (refer to <b>GIP-01: Bioretention</b> , for additional soil media information).	
Filter Fabric	A non-woven polypropylene geotextile with a flow rate of > 110 gal./min./sq. ft. (e.g., Geotex 351 or equivalent); Apply immediately above the choker stone.	
Choking Layer	A 3- inch layer of choker stone (typically #8 or # 89 washed gravel) laid above the underdrain stone.	
Stone and/or Storage Layer	A 12 to 18 inch layer (depending on the desired depth of the storage layer) of #57 stone should be double-washed and clean and free of all soil and fines.	
Underdrains, Cleanouts, and Observation Wells	6-inch PVC or HDPE pipe, with 3/8-inch perforations.	If needed, install perforated pipe for the full length of the water quality swale. Use non-perforated pipe, as needed, to connect with the storm drain system.
Vegetation	Plant species as specified on the landscaping plan	
Check Dams	Use non-erosive material such as wood, gabions, riprap, or concrete. All check dams should be underlain with filter fabric, and include weep holes. Wood used for check dams should consist of pressure-treated logs or timbers, or water-resistant tree species such as cedar, hemlock, swamp oak or locust.	
Erosion Control Fabric	Where flow velocities dictate, use woven biodegradable erosion control fabric or mats that are durable enough to last at least 2 growing seasons.	



## GIP – 05 SECTION 7: SPECIAL CASE DESIGN ADAPTATIONS

### 7.1 Steep Terrain

In areas of steep terrain, water quality swales can be implemented with contributing slopes of up to 20% gradient, as long as a multiple cell design is used to dissipate erosive energy prior to filtering. This can be accomplished by terracing a series of water quality swale cells to manage runoff across or down a slope. The drop in elevation between cells should be limited to 1 foot and armored with river stone or a suitable equivalent. A greater emphasis on properly engineered energy dissipaters and/or drop structures is warranted.

## GIP – 05 SECTION 8: CONSTRUCTION

### 8.1 Construction Erosion Prevention and Sediment Control

**Construction Stage EPSC Controls.** Water quality swales should be fully protected by silt fence or construction fencing, particularly if they will provide an infiltration function (i.e., have no underdrains). Ideally, water quality swale areas should remain *outside* the limits of disturbance during construction to prevent soil compaction by heavy equipment.

Water quality swale locations may be used for small sediment traps or basins during construction. However, these must be accompanied by notes and graphic details on the EPSC plan specifying that the maximum excavation depth of the sediment trap/basin at the construction stage must (1) be at least 1 foot above the depth of the post-construction water quality swale installation, (2) contain an underdrain, and (3) specify the use of proper procedures for conversion from a temporary practice to a permanent one, including de-watering, cleanout and stabilization.

### 8.2 Construction Sequence

The following is a typical construction sequence to properly install a water quality swale, although the steps may be modified as needed to adapt to different site conditions.

**Step 1: Protection during Site Construction.** As noted above, water quality swales should remain outside the limit of disturbance during construction to prevent soil compaction by heavy equipment. However, this is seldom practical given that swales are a key part of the drainage system at most sites. In these cases, temporary EPSC such as dikes, silt fences and other similar measures should be integrated into the swale design throughout the construction sequence. Specifically, barriers should be installed at key check dam locations, erosion control fabric should be used to protect the channel, and excavation should be no deeper than 2 feet above the proposed invert of the bottom of the planned underdrain. Water quality swales that lack underdrains (and rely on filtration) must be fully protected by silt fence or construction fencing to prevent compaction by heavy equipment during construction.

**Step 2.** Installation should begin after the entire contributing drainage area has been stabilized by vegetation. The designer should check the boundaries of the contributing drainage area to ensure it conforms to original design. Additional EPSC may be needed during swale construction, particularly to divert stormwater from the water quality swale until the filter bed and side slopes are fully stabilized. Pre-treatment cells should be excavated first to trap sediments before they reach the planned filter beds.



**Step 3.** Excavators or backhoes should work from the sides to excavate the water quality swale area to the appropriate design depth and dimensions. Excavating equipment should have scoops with adequate reach so they do not have to sit inside the footprint of the water quality swale area.

**Step 4.** The bottom of the water quality swale should be ripped, roto-tilled or otherwise scarified to promote greater infiltration.

**Step 5.** Place an acceptable filter fabric on the underground (excavated) sides of the water quality swale with a minimum 6 inch overlap. Place the stone needed for storage layer over the filter bed. Perforate the underdrain pipe and check its slope. Add the remaining stone jacket, and then pack #57 stone to 3 inches above the top of the underdrain, and then add 3 inches of choker stone as a filter layer.

**Step 6.** Add the soil media in 12-inch lifts until the desired top elevation of the water quality swale is achieved. Wait a few days to check for settlement, and add additional media as needed.

**Step 7.** Install check dams, driveway culverts and internal pre-treatment features, as specified in the plan.

**Step 8.** Prepare planting holes for specified trees and shrubs, install erosion control fabric where needed, spread seed or lay sod, and install any temporary irrigation.

**Step 9.** Plant landscaping materials as shown in the landscaping plan, and water them weekly during the first 2 months. The construction contract should include a care and replacement warranty to ensure that vegetation is properly established and survives during the first growing season following construction.

**Step 10.** Conduct a final construction inspection and develop a punch list for facility acceptance.

### 8.3 Construction Inspection

Inspections are needed during construction to ensure that the water quality swale is built in accordance with these specifications. Detailed inspection checklists should be used that include sign-offs by qualified individuals at critical stages of construction, to ensure that the contractor's interpretation of the plan is consistent with the designer's intent. Some common pitfalls can be avoided by careful construction supervision that focuses on the following key aspects of water quality swale installation.

- ❖ Check the filter media to confirm that it meets specifications and is installed to the correct depth.
- ❖ Check elevations such as the invert of the underdrain, inverts for the inflow and outflow points, and the ponding depth provided between the surface of the filter bed and the overflow structure.
- ❖ Ensure that caps are placed on the upstream (but not the downstream) ends of the underdrains.
- ❖ Make sure the desired coverage of turf or erosion control fabric has been achieved following construction, both on the filter beds and their contributing side-slopes.
- ❖ Inspect check dams and pre-treatment structures to make sure they are properly installed and working effectively.
- ❖ Check that outfall protection/energy dissipation measures at concentrated inflow and outflow points are stable.

The real test of a water quality swale occurs after its first big storm. The post-storm inspection should focus on whether the desired sheet flow, shallow concentrated flows or fully concentrated flows assumed in the plan actually occur in the field. Also, inspectors should check that the water quality swale drains completely within 24





hour drawdown period. Minor adjustments are normally needed as a result of this post-storm inspection (e.g., spot reseeding, gully repair, added armoring at inlets or outfalls, and check dam realignment).

## GIP – 05 SECTION 9: MAINTENANCE

### 9.1 Maintenance Document

Each BMP must have a Hamilton County Water Quality Stormwater Management Facility I&M Storm Water Management Facilities Agreement submitted for approval and maintained and updated by the BMP owner. The Stormwater Management Facilities I&M Agreement must be completed and submitted to the Program with the Land Disturbance permit application. The Stormwater Management Facilities I&M Agreement is for the use of the BMP owner in performing routine inspections. The developer/owner is responsible for the cost of maintenance and annual inspections. The BMP owner must maintain and update the BMP inspections and maintenance plan.

### 9.2. Maintenance Inspections

Annual inspections are used to trigger maintenance inspections such as sediment removal, spot revegetation and inlet stabilization. The following is a list of several key maintenance inspection points:

- ❖ Add reinforcement planting to maintain 95% turf cover or vegetation density. Reseed or replant any dead vegetation.
- ❖ Remove any accumulated sand or sediment deposits on the filter bed surface or in pretreatment cells.
- ❖ Inspect upstream and downstream of check dams for evidence of undercutting or erosion, and remove trash or blockages at weepholes.
- ❖ Examine filter beds for evidence of braiding, erosion, excessive ponding or dead grass.
- ❖ Check inflow points for clogging, and remove any sediment.
- ❖ Inspect side slopes and grass filter strips for evidence of any rill or gully erosion, and repair as needed.
- ❖ Look for any bare soil or sediment sources in the contributing drainage area, and stabilize immediately.
- ❖ Ideally, inspections should be conducted in the spring of each year.

### 9.3 Routine Maintenance and Inspection

Once established, water quality swales have minimal maintenance needs outside of the spring clean-up, regular mowing, and pruning and management of trees and shrubs. The surface of the filter bed can become clogged with fine sediment over time, but this can be alleviated through core aeration or deep tilling of the filter bed. Additional effort may be needed to repair check dams, stabilize inlet points and remove deposited sediment from pre-treatment cells.

## GIP – 05 SECTION 10: AS-BUILT REQUIREMENTS

After the water quality swale has been constructed, the developer must have an as-built certification of the swale prepared by a registered Professional Engineer and submit this to the Program. The as-built certification verifies that the BMP was installed as designed and approved.

The following components must be addressed in the as-built certification:

1. Appropriate underdrain system for water quality swales.
2. Correctly sized treatment volume.
3. Appropriate filter media and stone installed.
4. Adequate vegetation in place. Landscape plan must be provided.



5. Correct ponding depths and infiltration rates verified.
6. Overflow system in place for high flows.

## GIP – 05 SECTION 11: REFERENCES

Chesapeake Stormwater Network (CSN). 2008. *Technical Bulletin 1: Stormwater Design Guidelines for Karst Terrain in the Chesapeake Bay Watershed*. Version 1.0. Baltimore, MD. Available online at: <http://www.chesapeakestormwater.net/all-things-stormwater/stormwater-guidance-for-karst-terrain-in-the-chesapeake-bay.html>

City of Franklin, Stormwater Management Program. January 2014. *City of Franklin Stormwater Best Management Practices Manual*.

CWP. 2007. *National Pollutant Removal Performance Database, Version 3.0*. Center for Watershed Protection, Ellicott City, MD.

Claytor, R. and T. Schueler. 1996. *Design of Stormwater Filtering Systems*. Center for Watershed Protection. Ellicott City, MD.

Hirschman, D. and J. Kosco. 2008. *Managing Stormwater in Your Community: A Guide for Building an Effective Post-Construction Program*. EPA Publication 833-R-08-001, Tetra-Tech, Inc. and the Center for Watershed Protection. Ellicott City, MD.

Maryland Department of Environment (MDE). 2000. *Maryland Stormwater Design Manual*. Baltimore, MD. Available online at: [http://www.mde.state.md.us/Programs/WaterPrograms/SedimentandStormwater/stormwater design/index.asp](http://www.mde.state.md.us/Programs/WaterPrograms/SedimentandStormwater/stormwater%20design/index.asp)

Schueler, T., D. Hirschman, M. Novotney and J. Zielinski. 2007. *Urban stormwater retrofit practices*. Manual 3 in the Urban Subwatershed Restoration Manual Series. Center for Watershed Protection, Ellicott City, MD.

Schueler, T. 2008. Technical Support for the Baywide Runoff Reduction Method. Chesapeake Stormwater Network. Baltimore, MD. [www.chesapeakestormwater.net](http://www.chesapeakestormwater.net)

Virginia Department of Conservation and Recreation (VADCR). 1999. *Virginia Stormwater Management Handbook*. Volumes 1 and 2. Division of Soil and Water Conservation. Richmond, VA.

Virginia Department of Conservation and Recreation (VADCR). 2011. *Stormwater Design Specification No. 10: Dry Swales*. Version 1.9. Division of Soil and Water Conservation. Richmond, VA.



## GIP-05 APPENDIX A INFILTRATION SOIL TESTING PROCEDURES

### I. Test Pit/Boring Procedures

1. One test pit or standard soil boring should be provided for every 50 linear feet of the proposed infiltration area, with a minimum of two per swale.
2. The location of each test pit or standard soil boring should correspond to the location of the proposed infiltration area.
3. Excavate each test pit or penetrate each standard soil boring to a depth at least 2 feet below the bottom of the proposed infiltration area.
4. If the groundwater table is located within 2 feet of the bottom of the proposed facility, determine the depth to the groundwater table immediately upon excavation and again 24 hours after excavation is completed.
5. Determine the USDA or Unified Soil Classification system textures at the bottom of the proposed infiltration area and at a depth that is 2 feet below the bottom. All soil horizons should be classified and described.
6. If bedrock is located within 2 feet of the bottom of the proposed infiltration area, determine the depth to the bedrock layer.
7. Test pit/soil boring stakes should be left in the field to identify where soil investigations were performed.

### II. Infiltration Testing Procedures

1. One infiltration test should be conducted for every 50 linear feet of surface area for the infiltration area, with a minimum two per swale.
2. The location of each infiltration test should correspond to the location of the proposed infiltration area.
3. Install a test casing (e.g., a rigid, 4 to 6 inch diameter pipe) to a depth 2 feet below the bottom of the proposed infiltration area.
4. Remove all loose material from the sides of the test casing and any smeared soil material from the bottom of the test casing to provide a natural soil interface into which water may percolate. If desired, a 2-inch layer of coarse sand or fine gravel may be placed at the bottom of the test casing to prevent clogging and scouring of the underlying soils. Fill the test casing with clean water to a depth of 2 feet, and allow the underlying soils to presoak for 24 hours.
5. After 24 hours, refill the test casing with another 2 feet of clean water and measure the drop in water level within the test casing after one hour. Repeat the procedure three (3) additional times by filling the test casing with clean water and measuring the drop in water level after one hour. A total of four (4) observations must be completed. The infiltration rate of the underlying soils may be reported either as the average of all four observations or the value of the last observation. The infiltration rate should be reported in terms of inches per hour.
6. Infiltration testing may be performed within an open test pit or a standard soil boring. After infiltration testing is completed, the test casing should be removed and the test pit or soil boring should be backfilled and restored.





## Extended Detention



GIP - 06

Hamilton County



Water Quality Program

**Description:** Constructed stormwater detention basin that has a permanent pool (or micropool). Runoff from each rain event is captured and treated primarily through settling and biological uptake mechanisms.

**Variations:** Wet extended detention, micropool extended detention, multiple pond system

### Components:

- Permanent pool / micropool – prevents re-suspension of solids
- Live storage above permanent pool – sized for a percentage of water quality volume and flow attenuation.
- Forebay – settles out larger sediments in an area where sediment removal will be easier
- Spillway system – spillway system(s) provides outlet for stormwater runoff when large storm events occur and maintains the permanent pool

### Advantages/Benefits:

- Can be designed as a multi-functional BMP
- Cost effective
- Can be designed as an amenity within a development
- Wildlife habitat potential
- High community acceptance when integrated into a development

### Disadvantages/Limitations:

- Potential for thermal impacts downstream
- Not recommended in karst terrain
- Community perceived concerns with mosquitoes and safety

### Design considerations:

- Minimum contributing drainage area of 25 acres; 10 acres for micropool extended detention (Unless water balance calculations show support of permanent pool by a smaller drainage area)
- Sediment forebay or equivalent pretreatment must be provided
- Minimum length to width ratio = 3:1
- Maximum depth of permanent pool = 4'
- 3:1 side slopes or flatter around pond perimeter

### Selection Criteria:

**15% Runoff Reduction Credit  
 (0% if lined)**

### Land Use Considerations:

- Residential
- Commercial
- Industrial

### Maintenance:

- Remove debris from inlet and outlet structures
- Maintain side slopes/remove invasive vegetation
- Monitor sediment accumulation and remove periodically

**M** Maintenance Burden  
 L = Low M = Moderate H = High



## GIP – 06 SECTION 1: DESCRIPTION

An Extended Detention (ED) Pond relies on 24 to 48 hour detention of stormwater runoff after each rain event. An under-sized outlet structure restricts stormwater flow so it backs up and is stored within the basin. The temporary ponding enables particulate pollutants to settle out and reduces the maximum peak discharge to the downstream channel, thereby reducing the effective shear stress on banks of the receiving stream. ED differs from stormwater detention, since it is designed to achieve a minimum drawdown time, rather than a maximum peak rate of flow (which is commonly used to design for peak discharge or flood control purposes and often detains flows for just a few minutes or hours). ED ponds rely on gravitational settling as their primary pollutant removal mechanism. Consequently, they generally provide fair-to-good removal for particulate pollutants, but low or negligible removal for soluble pollutants, such as nitrate and soluble phosphorus. The use of ED alone generally results in a low overall pollutant removal. As a result, ED is normally combined with other practices to maximize pollutant removal rates.

## GIP – 06 SECTION 2: PERFORMANCE

Table GIP-06-01. Runoff Volume Reduction Provided by ED Ponds	
Stormwater Function	Specified Design
Runoff Volume Reduction (RR)	15%

Sources: CSN (2008), CWP (2007)

## GIP – 06 SECTION 3: DESIGN TABLE

ED ponds must be designed with a Storage Volume,  $T_v$ . **Table GIP-06-02** lists the criteria for qualifying designs. See **Section 6** for more detailed design guidelines.

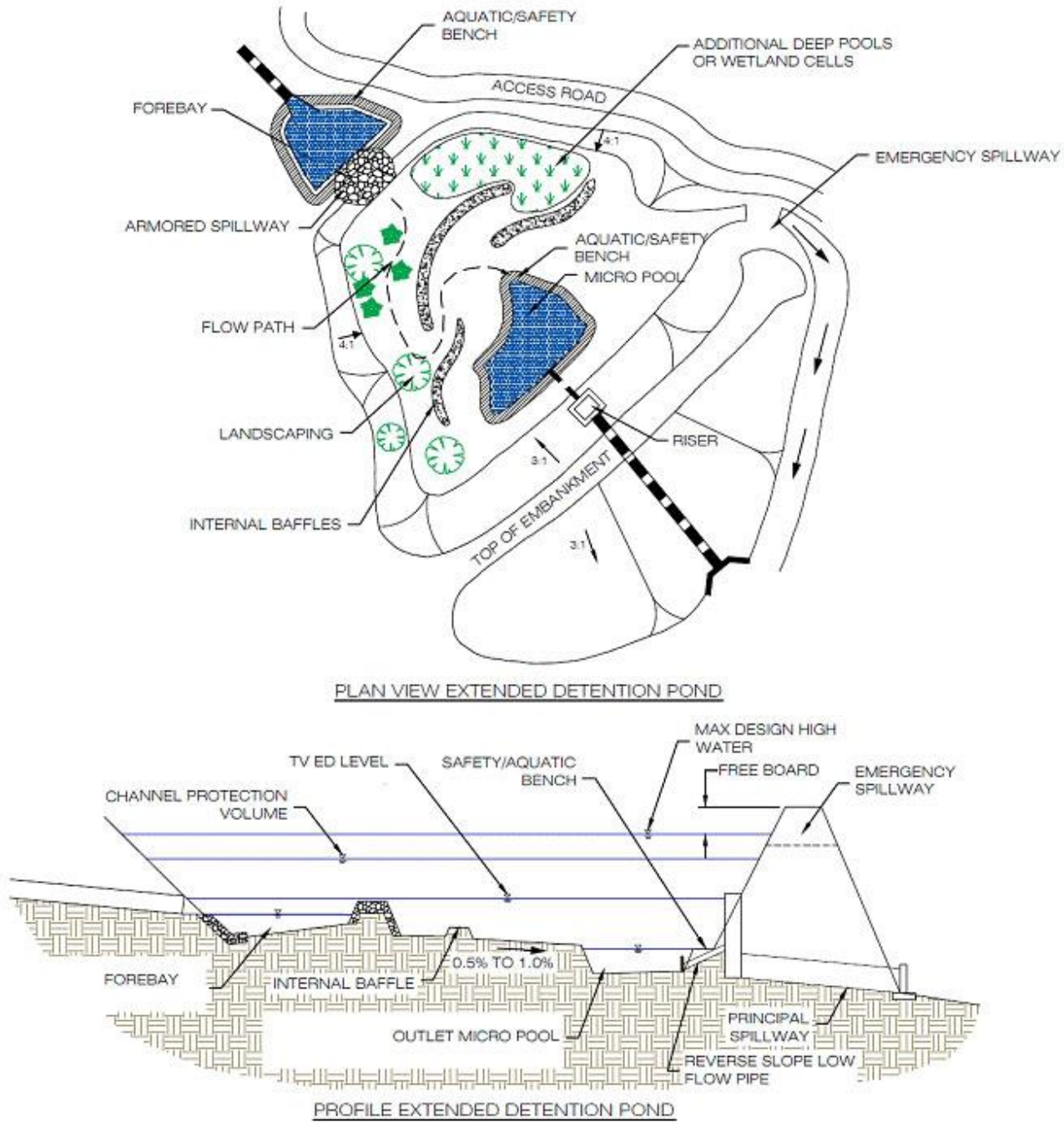
Table GIP-06-02. Extended Detention (ED) Pond Criteria
Specified Design (RR:15)
$T_v^1 = [(1.25) (R_v) (A)] * 3630$ – the volume reduced by an upstream BMP
A minimum of 40% of $T_v$ in the permanent pool (forebay, micropool, deep pool, or wetlands)
Length/Width ratio <i>OR</i> flow path = 3:1 or more
Length of the shortest flow path / overall length = 0.7 or more
Minimum $T_v$ ED time = 24 hours
Maximum vertical $T_v$ ED limit of 4 feet
Trees and wetlands in the planting plan
Includes additional cells or features (deep pools, wetlands, etc.) Refer to Section 5
CDA is greater than 10 acres unless water balance supports smaller contributing drainage area (CDA)

<sup>1</sup>A= Area in Acres



**GIP – 06 SECTION 4: TYPICAL DETAILS**

Figure GIP-06-01 portrays a typical schematic for an ED pond.



**Figure GIP-06-01. Typical Extended Detention Pond Details (source: VADCR, 2011)**





## GIP – 06 SECTION 5: PHYSICAL FEASIBILITY & DESIGN APPLICATIONS

The following feasibility issues need to be evaluated when ED ponds are considered as the final practice in a treatment train. Many of these issues will be influenced by the type of ED Pond being considered (refer to Design Applications at the end of this section).

**Space Required.** A typical ED pond requires a footprint of 1% to 3% of its contributing drainage area, depending on the depth of the pond (i.e., the deeper the pond, the smaller footprint needed).

**Contributing Drainage Area.** A minimum contributing drainage area of 10 acres is recommended for ED ponds in order to sustain a permanent micropool to protect against clogging. Extended detention may still work with drainage areas less than 10 acres, but designers should be aware that these “pocket” ponds will typically (1) have very small orifices that will be prone to clogging, (2) experience fluctuating water levels, and (3) generate more significant maintenance problems. Water balance calculations should also support a CDA less than 10 acres.

**Available Hydraulic Head.** The depth of an ED pond is usually determined by the amount of hydraulic head available at the site. The bottom elevation is normally the invert of the existing downstream conveyance system to which the ED pond discharges. Typically, a minimum of 6 to 10 feet of head is needed for an ED pond to function.

**Minimum Setbacks.** Local ordinances and design criteria should be consulted to determine minimum setbacks to property lines, structures, and wells. Generally, ED ponds should be set back at least 10 feet from property lines, 25 feet from building foundations, 50 feet from septic system fields, and 100 feet from private wells.

**Depth-to-Water Table and Bedrock.** If less than 3 feet of vertical separation exists between the bottom of the ED pond and the underlying soil-bedrock interface, ED ponds should not be used unless they have an acceptable liner.

**Soils.** The permeability of soils is seldom a design constraint for micropool ED ponds. Soil infiltration tests need to be conducted at proposed pond sites to estimate infiltration rates, which can be significant in Hydrologic Soil Group (HSG) A soils and some group B soils. Infiltration through the bottom of the pond is encouraged unless it will impair the integrity of the embankment. Geotechnical tests should be conducted to determine the infiltration rates and other subsurface properties of the soils underlying the proposed ED pond. If the site is on karst topography, an alternative practice or combination of practices should be employed at the site, if possible. See Technical bulletin No. 1 (CSN, 2009) for guidance on stormwater design in karst terrain. The Extended Detention Basin should be the option of last resort and, if used in karst, must have an impermeable clay or (preferably) geosynthetic liner.

### **Design Applications**

Extended Detention is normally combined with other stormwater treatment options within the stormwater facility (e.g., wet ponds, and constructed wetlands) to enhance its performance and appearance. Other design variations are also possible where a portion of the runoff is directed to bioretention, infiltration, etc., that are within the overall footprint but housed in a separate cell, where the ponding depth of the Tv and/or flood protection storage is limited by the criteria of that particular practice.

While ED ponds can provide for flood protection, they will rarely provide adequate runoff volume reduction and pollutant removal to serve as a stand-alone compliance strategy. Therefore, designers should always maximize



the use of upland runoff reduction practices, (e.g., rooftop disconnections, small-scale infiltration, rainwater harvesting, bioretention, grass channels and water quality swales) that reduce runoff at its source (rather than merely treating the runoff at the terminus of the storm drain system). Upland runoff reduction practices can be used to satisfy most or all of the runoff reduction requirements at most sites. Upland runoff reduction practices will greatly reduce the size, footprint and cost of the downstream ED pond.

## GIP – 06 SECTION 6: DESIGN CRITERIA

### 6.1 Overall Sizing

Designers can use a site-adjusted  $R_v$  (see **Chapter 3.2** of **Volume 5** for appropriate equations), which reflects the use of upland runoff reduction practices, to compute the remaining treatment and flood protection volumes that must be treated by the ED pond. ED ponds should then be designed to capture and treat the remaining runoff volume as necessary, using methodology found below and in **Volume 4 PTP-06**. Runoff treatment ( $T_v$ ) credit may be taken for the entire water volume below the permanent pool elevation of any micropools, forebays and wetland areas, as well as, the temporary extended detention above the normal pool. A minimum of 40% of the  $T_v$  must be designed into the permanent pool.

#### Equation 6.1. ED Treatment Volume

$$T_v \text{ (cu. ft.)} = (\text{Original } T_v - \text{the volume reduced by an upstream BMP})$$

After calculating  $T_v$ , the forebay should be sized using guidance in **Section 6.4**.

The outlets must then be sized for appropriate storm events. If the pond is additionally going to address peak flow attenuation, the downstream impacts must be considered for the 2-through 100-year events. Refer to **Volume 4 PTP-01** and **Volume 2 Chapter 8** for instruction on design of outlet orifices and weirs.

### 6.2 Treatment Volume Drawdown and Detention Design

Low flow orifices can be sized using the following equation, as provided in **Volume 4 PTP-06**. For more information on the design of outlet orifices and weirs and for achieving the target drawdown of the Treatment Volume design, refer to **Volume 2 Chapter 8**. If different equation is used or different type of low flow orifice is used, provide supporting calculations.

#### Equation 6.2. Area of Low Flow Orifice

$$a = \frac{2A(H - H_o)^{0.5}}{3600CT(2g)^{0.5}}$$

Where:

a	=	Area of orifice (ft <sup>2</sup> )
A	=	Average surface area of the pond (ft <sup>2</sup> )
C	=	Orifice coefficient, 0.66 for thin, 0.80 for materials thicker than orifice diameter
T	=	Drawdown time of pond (hrs.), must be greater than 24 hours
g	=	Gravity (32.2 ft/sec <sup>2</sup> )
H	=	Elevation when pond is full to storage height (ft)
H <sub>o</sub>	=	Final elevation when pond is empty (ft)

**Table 6.2** provides maximum ponding depths and other criteria for providing runoff volume reduction.



Once the low flow orifice has been sized, design embankments and emergency spillways, investigate potential dam hazard classifications, and finally design inlets, sediment forebays, outlet structures, maintenance access, and safety features. These items are detailed in both Section 6.5 and below.

### 6.3 Required Geotechnical Testing

Soil borings should be taken below the proposed embankment, in the vicinity of the proposed outlet area, and in at least two locations within the proposed ED pond treatment area. Soil boring data is needed to (1) determine the physical characteristics of the excavated material, (2) determine its adequacy for use as structural fill or spoil, (3) provide data for structural designs of the outlet works (e.g., bearing capacity and buoyancy), (4) determine compaction/composition needs for the embankment, (5) determine the depth to groundwater and bedrock and (6) evaluate potential infiltration losses (and the potential need for a liner).

### 6.4 Pretreatment Forebay

Sediment forebays are considered to be an integral design feature to maintain the longevity of ED ponds. A forebay must be located at each major inlet to trap sediment and preserve the capacity of the main treatment cell. Other forms of pre-treatment for sheet flow and concentrated flow for minor inflow points should be designed consistent with pretreatment criteria found in **GIP-01 Bioretention**. The following criteria apply to forebay design:

- ❖ A major inlet is defined as an individual storm drain inlet pipe or open channel serving at least 10% of the ED pond's contributing drainage area.
- ❖ The forebay consists of a separate cell, formed by an acceptable barrier. (e.g., an earthen berm, concrete weir, gabion baskets, etc.).
- ❖ The forebay should be at least 4 feet deep and must be equipped with a variable width aquatic bench for safety purposes. The aquatic benches should be 4 to 6 feet wide at a depth of 18 inches below the water surface.
- ❖ The total volume of all forebays should be at least 15% of the total Treatment Volume. The relative size of individual forebays should be proportional to the percentage of the total inflow to the pond. Similarly, any outlet protection associated with the end section or end wall should be designed according to state or local design standards.
- ❖ The forebay should be designed in such a manner that it acts as a level spreader to distribute runoff evenly across the entire bottom surface area of the main treatment cell.
- ❖ The bottom of the forebay may be hardened (e.g., concrete, asphalt, or grouted riprap) in order to make sediment removal easier.

### 6.5 Conveyance and Overflow

**No Pilot Channels.** Micropool ED ponds shall not have a low flow pilot channel, but instead must be constructed in a manner whereby flows are evenly distributed across the pond bottom, to promote the maximum infiltration possible.

**Internal Slope.** The maximum longitudinal slope through the pond should be approximately 0.5% to 1% to promote positive flow through the ED pond.

**Primary Spillway.** The primary spillway shall be designed with acceptable anti-flotation, anti-vortex, and trash rack devices. The spillway must generally be accessible from dry land.

**Non-Clogging Low Flow Orifice.** ED Ponds with drainage areas of 10 acres or less, where small diameter pipes are typical, are prone to chronic clogging by organic debris and sediment. Orifices less than 3 inches in diameter may





require extra attention during design to minimize the potential for clogging. Designers should always look at upstream conditions to assess the potential for higher sediment and woody debris loads. The risk of clogging in outlet pipes with small orifices can be reduced by:

- ❖ Providing a micropool at the outlet structure:
  - Use a reverse-sloped pipe that extends to a mid-depth of the permanent pool or micropool.
  - Install a downturned elbow or half-round CMP over a riser orifice (circular, rectangular, V-notch, etc.) to pull water from below the micropool surface.
  - The depth of the micropool should be at least 4 feet deep, and the depth may not draw down by more than 2 feet during 30 consecutive days of dry weather in the summer.
- ❖ Providing an over-sized forebay to trap sediment, trash and debris before it reaches the ED pond's low-flow orifice.
- ❖ Installing a trash rack to screen the low-flow orifice.
- ❖ Using a perforated pipe under a gravel blanket with an orifice control at the end in the riser structure to supplement the primary outlet.

**Emergency Spillway.** ED ponds must be constructed with overflow capacity to pass the 100-year design storm event through either the Primary Spillway or a vegetated or armored Emergency Spillway.

**Adequate Outfall Protection.** The design must specify an outfall that will be stable for the 10- year design storm event. The channel immediately below the pond outfall must be modified to prevent erosion and conform to natural dimensions in the shortest possible distance. This is typically done by placing appropriately sized riprap, over filter fabric, which can reduce flow velocities from the principal spillway to non-erosive levels (3.5 to 5.0 fps depending on the channel lining material). Flared pipe sections that discharge at or near the stream invert or into a step pool arrangement should be used at the spillway outlet.

**Inlet Protection.** Inlet areas should be stabilized to ensure that non-erosive conditions exist during storm events up to the overbank flood event (i.e., the 10-year storm event). Inlet pipe inverts should generally be located at or slightly below the forebay pool elevation.

**On-Line ED Ponds** must be designed to detain the required  $T_v$  and either manage or be capable of safely passing larger storm events conveyed to the pond (e.g., 10-year flood protection, and/or the 100-year design storm event).

## 6.6. Internal Design Features

**Side Slopes.** Side slopes leading to the ED pond should generally have a gradient of 4H:1V to 5H:1V. The mild slopes promote better establishment and growth of vegetation and provide for easier maintenance and a more natural appearance.

**Long Flow Path.** ED pond designs should have an irregular shape and a long flow path from inlet to outlet to increase water residence time, treatment pathways, and pond performance. In terms of flow path geometry, there are two design considerations: (1) the overall flow path through the pond, and (2) the length of the shortest flow path (Hirschman et al., 2009):

- ❖ The overall flow path can be represented as the length-to-width ratio *OR* the flow path. These ratios must be at least 3L:1W. Internal berms, baffles, or topography can be used to extend flow paths and/or create multiple pond cells.



- ❖ The shortest flow path represents the distance from the closest inlet to the outlet. The ratio of the shortest flow to the overall length must be at least 0.7. In some cases – due to site geometry, storm sewer infrastructure, or other factors – some inlets may not be able to meet these ratios. However, the drainage area served by these “closer” inlets should constitute no more than 20% of the total contributing drainage area.

**Treatment Volume Storage.** The total  $T_v$  storage may be provided by a combination of the permanent pool (in the form of forebays, deep pools, and/or wetland area) and extended detention storage.

**Vertical Extended Detention Limits.** The maximum  $T_v$  ED water surface elevation may not extend more than 4 feet above the basin floor or normal pool elevation. The maximum vertical elevation for ED detention over shallow wetlands is 1 foot. Frequent fluctuations in water elevations, or bounce effect, are not as critical for larger flood control storms (e.g., the 10-year design storm), and these events can exceed the 4 foot vertical limit if they are managed by a multi-stage outlet structure.

#### **Safety Features.**

- ❖ The principal spillway opening must be designed and constructed to prevent access by small children.
- ❖ End walls above pipe outfalls greater than 48 inches in diameter must be fenced to prevent a hazard.
- ❖ An emergency spillway and associated freeboard must be provided in accordance with applicable local or state dam safety requirements. The emergency spillway must be located so that downstream structures will not be impacted by spillway discharges.
- ❖ Both the safety bench and the aquatic bench should be landscaped with vegetation that hinders or prevents access to the pool.

### **6.7 Landscaping and Planting Plan**

A landscaping plan must be provided that indicates the methods used to establish and maintain vegetative coverage within the ED pond. Minimum elements of a plan include the following:

- ❖ Delineation of pond-scaping zones within the pond
- ❖ Selection of corresponding plant species
- ❖ The planting plan
- ❖ The sequence for preparing the wetland bed, if one is incorporated with the ED pond (including soil amendments, if needed)
- ❖ Sources of plant material
- ❖ The planting plan should allow the pond to mature into a native forest in the right places, but yet keep mowable turf along the embankment and all access areas. The wooded wetland concept proposed by Capiella *et al.*, (2005) may be a good option for many ED ponds.
- ❖ Woody vegetation may not be planted or allowed to grow within 15 feet of the toe of the embankment nor within 25 feet from the principal spillway structure.
- ❖ Avoid species that require full shade, or are prone to wind damage. Extra mulching around the base of trees and shrubs is strongly recommended as a means of conserving moisture and suppressing weeds.

For more guidance on planting trees and shrubs in ED ponds consult Capiella et al (2006).

### **6.8 Maintenance Reduction Features**

Good maintenance access is needed so crews can remove sediments from the forebay, alleviate clogging and make riser repairs. The following ED pond maintenance issues can be addressed during design, in order to make on-going maintenance easier:



- ❖ Adequate maintenance access must extend to the forebay, micropool, any safety benches, riser, and outlet structure and must have sufficient area to allow vehicles to turn around.
- ❖ The riser should be located within the embankment for maintenance access, safety and aesthetics.
- ❖ Access roads must (1) be constructed of load-bearing materials or be built to withstand the expected frequency of use, (2) have a minimum width of 12 feet, and (3) have a profile grade that does not exceed 15%. Steeper grades are allowable if appropriate stabilization techniques are used, such as a gravel road.
- ❖ A maintenance right-of-way or easement must extend to the ED pond from a public or private road.

### 6.9 ED Pond Material Specifications

ED ponds are generally constructed with materials obtained on-site, except for the plant materials, inflow and outflow devices (e.g., piping and riser materials), possibly stone for inlet and outlet stabilization, and filter fabric for lining banks or berms.

The basic material specifications for earthen embankments, principal spillways, vegetated emergency spillways and sediment forebays shall be as specified in Tennessee state guidelines and TRM-06, Dry Ponds in within this manual.

### 6.10 Dam Safety

Tennessee Safe Dams Act may apply to ponds with storage volumes and embankment heights large enough to fall under the regulation for dam safety, as applicable. Size emergency spillway for any overtopping of pond in case of rain event in excess of 100-year storm and for instances of malfunction or clogging of primary outlet structure.

## GIP – 06 SECTION 7: SPECIAL CASE DESIGN ADAPTATIONS

### 7.1 Steep Terrain

The use of ED ponds is highly constrained at development sites with steep terrain.

### 7.2 Karst Terrain

Karst is found in some areas of the Program. The presence of karst complicates both land development in general and stormwater design in particular. Designers should always conduct geotechnical investigations in karst terrain to assess this risk during the project planning stage. Because of the risk of sinkhole formation and groundwater contamination in karst regions, *use of ED ponds is highly restricted* (see CSN Technical Bulletin No. 1, 2009). If these studies indicate that less than 3 feet of vertical separation exists between the bottom of the ED pond and the underlying soil-bedrock interface, ED ponds should not be used unless they have an acceptable liner.

### 7.3 Multi-Functional Uses

Recreational and other uses may be provided between storm runoff events, as shown in **Figure GIP-06-02**.



**Figure GIP-06-02. Multi-Use Dry Detention Doubling as Sports Fields Englewood, CO**





## GIP – 06 SECTION 8: CONSTRUCTION

### 8.1 Construction Sequence

The following is a typical construction sequence to properly install an ED pond. The steps may be modified to reflect different dry ED pond designs, site conditions, and the size, complexity and configuration of the proposed facility.

**Step 1: Use of ED pond as an EPSC.** An ED pond may serve as a sediment basin during project construction. If this is done, the volume should be based on the more stringent sizing rule (erosion and sediment control requirement vs. water quality treatment requirement). Installation of the permanent riser should be initiated during the construction phase, and design elevations should be set with final cleanout of the sediment basin and conversion to the post-construction ED pond in mind. The bottom elevation of the ED pond should be lower than the bottom elevation of the temporary sediment basin. Appropriate procedures should be implemented to prevent discharge of turbid waters when the basin is being converted into an ED pond.

**Step 2: Stabilize the Drainage Area.** ED ponds should only be constructed after the contributing drainage area to the pond is completely stabilized or if water is routed around them during construction. If the proposed pond site will be used as a sediment trap or basin during the construction phase, the construction notes should clearly indicate that the facility will be dewatered, dredged and re-graded to design dimensions after the original site construction is complete.

**Step 3: Assemble Construction Materials** on-site, make sure they meet design specifications, and prepare any staging areas.

**Step 4: Clear and Strip** the project area to the desired sub-grade.

**Step 5: Install EPSC Controls** prior to construction, including temporary de-watering devices and stormwater diversion practices. All areas surrounding the pond that are graded or denuded during construction must be planted with turf grass, native plantings, or other approved methods of soil stabilization.

**Step 6: Excavate the Core Trench and Install the Spillway Pipe.**

**Step 7: Install the Riser or Outflow Structure** and ensure the top invert of the overflow weir is constructed level at the design elevation.

**Step 8: Construct the Embankment and any Internal Berms** in 8 to 12-inch lifts and compact the lifts with appropriate equipment.

**Step 9: Excavate/Grade** until the appropriate elevation and desired contours are achieved for the bottom and side slopes of the ED pond.

**Step 10: Construct the Emergency Spillway** in cut or structurally stabilized soils.

**Step 11: Install Outlet Pipes**, including downstream rip-rap apron protection and/or channel armor, as necessary.



**Step 12: Stabilize Exposed Soils** with temporary seed mixtures appropriate for the pond. All areas above the normal pool elevation should be permanently stabilized by hydroseeding or seeding over straw.

**Step 13: Plant the Pond Area**, following the pond-scaping plan (see **Section 6.7**).

## 8.2 Construction Inspection

Multiple inspections are critical to ensure that stormwater ponds are properly constructed. Inspections are recommended during the following stages of construction:

- ❖ Pre-construction meeting
- ❖ Initial site preparation (including installation of EPSC controls)
- ❖ Excavation/Grading (interim and final elevations)
- ❖ Installation of the embankment, the riser/primary spillway, and the outlet structure
- ❖ Implementation of the pond-scaping plan and vegetative stabilization
- ❖ Final inspection (develop a punch list for facility acceptance)

If the ED pond has a permanent pool, then to facilitate maintenance the contractor should measure the actual constructed pond depth at three areas within the permanent pool (forebay, mid-pond and at the riser), and they should mark and geo-reference them on an as-built drawing. This simple data set will enable maintenance inspectors to determine pond sediment deposition rates in order to schedule sediment cleanouts.

## GIP – 06 SECTION 9: MAINTENANCE

### 9.1 Maintenance Document

Each BMP must have a Hamilton County Water Quality Stormwater Management Facility I&M Storm Water Management Facilities Agreement submitted for approval and maintained and updated by the BMP owner. The Stormwater Management Facilities I&M Agreement must be completed and submitted to the Program with the Land Disturbance permit application. The Stormwater Management Facilities I&M Agreement is for the use of the BMP owner in performing routine inspections. The developer/owner is responsible for the cost of maintenance and annual inspections. The BMP owner must maintain and update the BMP inspection and maintenance plan.

### 9.2 Maintenance Inspections

Maintenance of ED ponds is driven by annual inspections that evaluate the condition and performance of the pond, including the following:

- ❖ Measure sediment accumulation levels in forebay.
- ❖ Monitor the growth of wetlands, trees and shrubs planted, and note the presence of any invasive plant species.
- ❖ Inspect the condition of stormwater inlets to the pond for material damage, erosion or undercutting.
- ❖ Inspect the banks of upstream and downstream channels for evidence of sloughing, animal burrows, boggy areas, woody growth, or gully erosion that may undermine embankment integrity.
- ❖ Inspect pond outfall channel for erosion, undercutting, rip-rap displacement, woody growth, etc.
- ❖ Inspect condition of principal spillway and riser for evidence of spalling, joint failure, leakage, corrosion, etc.



- ❖ Inspect condition of all trash racks, reverse sloped pipes or flashboard risers for evidence of clogging, leakage, debris accumulation, etc.
- ❖ Inspect maintenance access to ensure it is free of woody vegetation, and check to see whether valves, manholes and locks can be opened and operated.
- ❖ Inspect internal and external side slopes of the pond for evidence of sparse vegetative cover, erosion, or slumping, and make needed repairs immediately.

### 9.3 Common Ongoing Maintenance Issues

ED ponds are prone to a high clogging risk at the ED low-flow orifice. This component of the pond's plumbing should be inspected at least twice a year after initial construction. The constantly changing water levels in ED ponds make it difficult to mow or manage vegetative growth. The bottom of ED ponds often become soggy, and water-loving trees such as willows may take over. The maintenance plan should clearly outline how vegetation in the pond will be managed or harvested in the future.

The maintenance plan should schedule a cleanup at least once a year to remove trash and floatables that tend to accumulate in the forebay, micropool, and on the bottom of ED ponds.

Frequent sediment removal from the forebay is essential to maintain the function and performance of an ED pond. Maintenance plans should schedule cleanouts every 5 to 7 years, or when inspections indicate that 50% of the forebay capacity has been filled. Sediments excavated from ED ponds are not usually considered toxic or hazardous, and can be safely disposed by either land application or land filling.

## GIP – 06 SECTION 10: AS-BUILT REQUIREMENTS

After the pond is constructed, an as-built certification of the pond, performed by a registered Professional Engineer, must be submitted to the Program. The as-built certification verifies that the BMP was installed as designed and approved. The following are additional components which must be addressed in the as-built certification:

1. Pretreatment for coarse sediments must be provided.
2. Surrounding drainage areas must be stabilized to prevent sediment from clogging the filter media.
3. Correct ponding depths and infiltration rates must be maintained to prevent killing vegetation.
4. A mechanism for overflow for large storm events must be provided.

## GIP – 06 SECTION 11: COMMUNITY AND ENVIRONMENTAL CONCERNS

Extended Detention Ponds can generate the following community and environmental concerns that need to be addressed during design.

**Aesthetics.** ED ponds tend to accumulate sediment and trash, which residents are likely to perceive as unsightly and creating nuisance conditions. Fluctuating water levels in ED ponds also create a difficult landscaping environment. In general, designers should avoid designs that rely solely on *dry* ED ponds.

**Existing Wetlands.** ED ponds should never be constructed within existing *natural* wetlands, nor should they inundate or otherwise change the hydroperiod of existing wetlands.





**Existing Forests.** Designers can expect a great deal of neighborhood opposition if they do not make a concerted effort to save mature trees during design and pond construction. Designers should also be aware that even modest changes in inundation frequency can kill upstream trees (Cappiella *et al.*, 2007).

**Safety Risk.** ED ponds are generally considered to be safer than other pond options, since they have few deep pools. Steep side-slopes and unfenced headwalls, however, can still create some safety risks. Gentle side slopes should be provided to avoid potentially dangerous drop-offs, especially where ED ponds are located near residential areas.

**Mosquito Risk.** The fluctuating water levels within ED ponds have potential to create conditions that lead to mosquito breeding. Mosquitoes tend to be more prevalent in irregularly flooded ponds than in ponds with a permanent pool (Santana *et al.*, 1994). Designers can minimize the risk by combining ED with a wet pond or wetland.

## GIP – 06 SECTION 12: REFERENCES

Chesapeake Stormwater Network (CSN). 2008. *Technical Bulletin 1: Stormwater Design Guidelines for Karst Terrain in the Chesapeake Bay Watershed*. Version 1.0. Baltimore, MD. Available online at: <http://www.chesapeakestormwater.net/all-things-stormwater/stormwater-guidance-for-karst-terrain-in-the-chesapeake-bay.html>

Cappiella, K., T. Schueler and T. Wright. 2005. *Urban Watershed Forestry Manual: Part 1: Methods for Increasing Forest Cover in a Watershed*. USDA Forest Service. Center for Watershed Protection. Ellicott City, MD.

Cappiella, K., T. Schueler and T. Wright. 2006. *Urban Watershed Forestry Manual: Part 2: Conserving and Planting Trees at Development Sites*. USDA Forest Service. Center for Watershed Protection. Ellicott City, MD.

Cappiella, K., T. Schueler, J. Tomlinson, T. Wright. 2007. *Urban Watershed Forestry Manual: Part 3: Urban Tree Planting Guide*. USDA Forest Service. Center for Watershed Protection. Ellicott City, MD.

Cappiella, K., L. Fraley-McNeal, M. Novotney and T. Schueler. 2008. "The Next Generation of Stormwater Wetlands." *Wetlands and Watersheds Article No. 5*. Center for Watershed Protection. Ellicott City, MD.

Center for Watershed Protection. 2004. *Pond and Wetland Maintenance Guidebook*. Ellicott City, MD.

CWP. 2007. *National Pollutant Removal Performance Database, Version 3.0*. Center for Watershed Protection, Ellicott City, MD

Chesapeake Stormwater Network (CSN). 2008. *Technical Bulletin 1: Stormwater Design Guidelines for Karst Terrain in the Chesapeake Bay Watershed*. Version 1.0. Baltimore, MD.

Chesapeake Stormwater Network (CSN). 2009. Technical Bulletin No. 1. Stormwater Guidance for Karst Terrain in the Chesapeake Bay Watershed, Version 2.0. Retrieved from [www.chesapeakestormwater.net/all-things-stormwater/category/policy-design-issues](http://www.chesapeakestormwater.net/all-things-stormwater/category/policy-design-issues).



City of Franklin, Stormwater Management Program. January 2014. *City of Franklin Stormwater Best Management Practices Manual*.

Hirschman, D., L. Woodworth and S. Drescher. 2009. *Technical Report: Stormwater BMPs in Virginia's James River Basin: An Assessment of Field Conditions & Programs*. Center for Watershed Protection. Ellicott City, MD.

Maryland Department of Environment (MDE). 2000. *Maryland Stormwater Design Manual*. Baltimore, MD. Available online at: [www.mde.state.md.us/Programs/WaterPrograms/SedimentandStormwater/stormwaterdesign/index.asp](http://www.mde.state.md.us/Programs/WaterPrograms/SedimentandStormwater/stormwaterdesign/index.asp).

Santana, F.J., J.R. Wood, R.E. Parsons, & S.K. Chamberlain. 1994. Control of Mosquito Breeding in Permitted Stormwater Systems. Brooksville: Sarasota County Mosquito Control and Southwest Florida Water Management District.

Schueler, T., D. Hirschman, M. Novotney and J. Zielinski. 2007. *Urban Stormwater Retrofit Practices*. Manual 3 in the Urban Subwatershed Restoration Manual Series. Center for Watershed Protection, Ellicott City, MD.

Virginia Department of Conservation and Recreation (VADCR). 1999. *Virginia Stormwater Management Handbook. Volumes 1 and 2*. Division of Soil and Water Conservation. Richmond, VA.

Virginia Department of Conservation and Recreation (VADCR). 2011. *Virginia DCR Stormwater Design Specification No. 15, Extended Detention (ED) Pond, Version 1.9, March 1, 2011*. Division of Soil and Water Conservation. Richmond, VA.



## Downspout Disconnection



GIP - 07

Hamilton County



Water Quality Program

**Description:** Refers to disconnecting roof downspouts and directing flow away from sewer inlets and impervious areas such as driveways, parking lots, and roads that provide direct connections to a public stormwater system, and directing them instead to a storage facility or pervious areas for infiltration. Downspouts can be directed to rain barrels, rain gardens, on-site filters, grassy areas (vegetated filters) and vegetated swales.

### Advantages/Benefits:

- Cost effective
- Promotes infiltration, reducing runoff volume & peak discharge
- Vegetated areas for infiltration provide aesthetics
- Increases public awareness and involvement

### Disadvantages/Limitations:

- For appreciable volume and peak discharge reduction, must be applied broadly
- Requires owner buy-in and maintenance to ensure proper drainage
- May require large on-lot pervious areas
- Must avoid causing foundation flooding or ice hazards
- Difficult to regulate and oversee, especially for subdivision grading permit projects

### Design considerations:

- For Soil Groups C or D, alternative runoff reduction practices (e.g., compost-amended filter path, bioretention, rainwater harvesting) are necessary to boost runoff reduction rate.
- When designing simple disconnections, soil erodibility must be considered & clearly stipulated in the site's Maintenance Plan.
- Maintenance of disconnected downspouts usually involves periodic lawn or landscaping maintenance in the filter path, unless directed to rain barrel or a natural, undisturbed setting.
- Must be a minimum distance of 10 feet outside the water quality buffer.
- Must be a minimum distance of 500 feet from steep slopes or landslide-prone areas.

### Selection Criteria:

**25-50% Runoff Reduction Credit**

### Land Use Considerations:

- Residential (limited use)
- Commercial
- Industrial

### Maintenance:

- On-site systems need to be maintained to ensure proper drainage to avoid nuisance flooding.

**Maintenance Burden**  
L = Low M = Moderate H = High





## GIP – 07 SECTION 1: DESCRIPTION

This strategy involves managing runoff close to its source by intercepting, infiltrating, filtering, treating or reusing it as it moves from the impervious surface to the drainage system. Two kinds of disconnection are allowed: (1) simple disconnection, whereby rooftops and/or on-lot residential impervious surfaces are directed to pervious areas, and (2) disconnection leading to an alternative runoff reduction practice(s) adjacent to the roof (**Figure 7.1**). Alternative practices that take up less space can be used where space is not available for the disconnection practices described above. Applicable alternative runoff practices are shown in **Table 7.1**, below.

## GIP – 07 SECTION 2: PERFORMANCE

With proper design and maintenance, simple rooftop disconnection options can provide relatively high runoff reduction rates based on soil type (**Table GIP-07-01**). An alternative runoff reduction practice may also be employed to achieve rooftop disconnection. In this case, the higher runoff reduction rate for that practice is used for the contributing drainage area of the rooftop. Simple rooftop disconnection can be used as the first GIP in a series to increase runoff reduction. Please see **Section 2.3.3: Rv Values for Controls in Series** for additional information.

**Table GIP-07-01. Runoff Volume Reduction Provided by Rooftop Disconnection**<sup>1</sup>

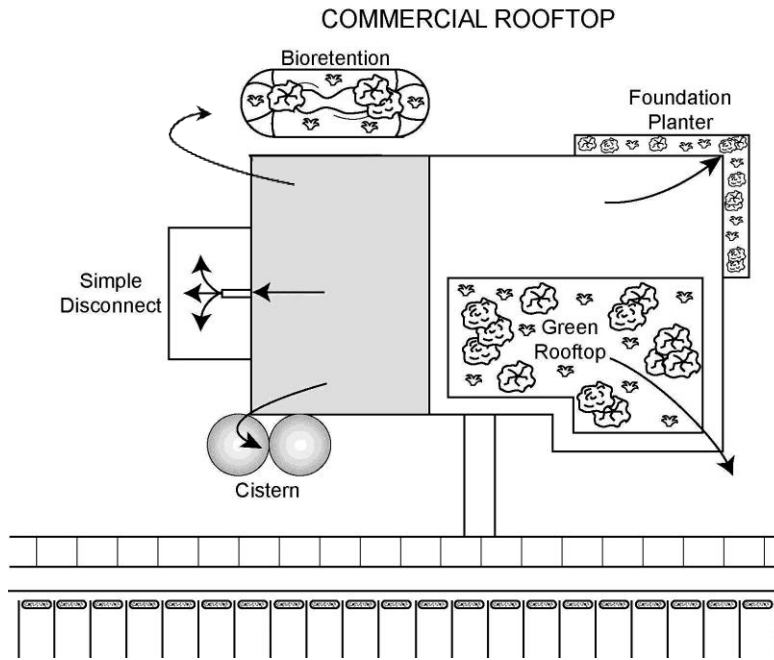
FUNCTION PROVIDED BY SIMPLE ROOFTOP DISCONNECTION	Level 1 HSG Soils C and D	Level 2 HSG SOILS A and B
<b>Runoff Volume Reduction (RR)</b>	25%	50%
<b>NOTE:</b> Stormwater functions of disconnection can assume a greater runoff reduction rate by employing an acceptable alternative runoff reduction practice. Acceptable practices and their associated runoff reduction rates are listed below. Designers should consult the applicable specification number for design standards.		
Alternative Practice	Specification No.	Runoff Reduction Rate
<b>Soil compost-amended filter path</b>	See Section 4.2	50%
<b>Infiltration trench – Level 1</b>	4	50%
<b>Infiltration trench – Level 2</b>	4	90%
<b>Bioretention – Level 1</b>	1	60%
<b>Bioretention – Level 2</b>	1	80%
<b>Rainwater harvesting</b>	11	Defined by user
<b>Stormwater Planter (Urban Bioretention)</b>	2	60%

<sup>1</sup> CSN (2008), CWP (2007)

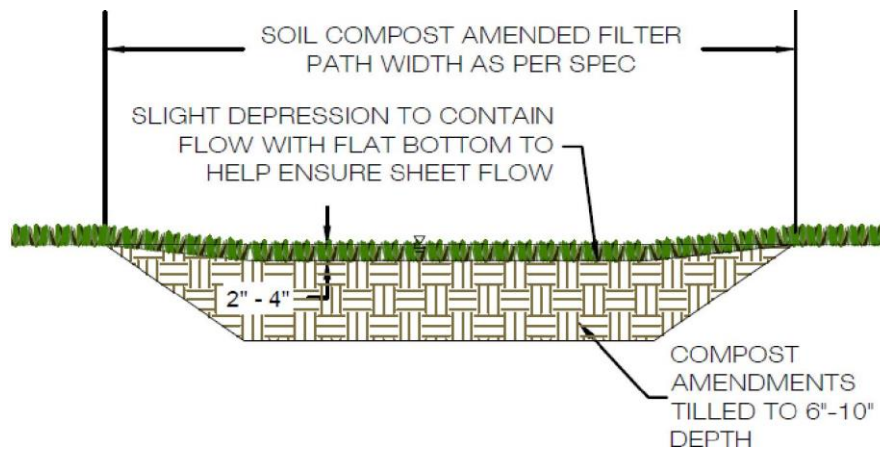


**GIP – 07 SECTION 3: TYPICAL DETAILS**

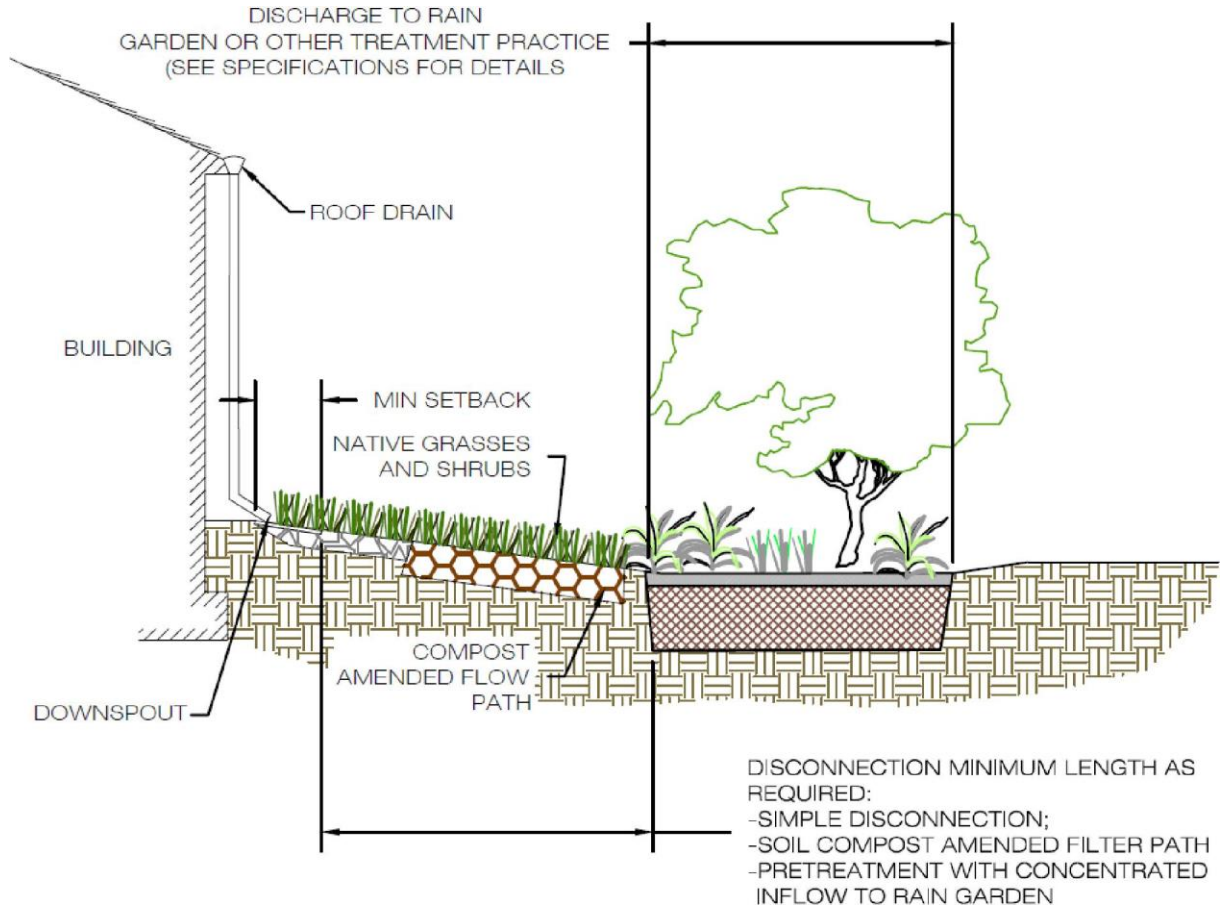
Figures GIP-07-01 through GIP-07-03 portrays various rooftop disconnection and alternative runoff reduction options.



**Figure GIP-07-01. Roof Disconnection with Alternative Runoff Reduction Practices (Source: VADCR, 2011)**

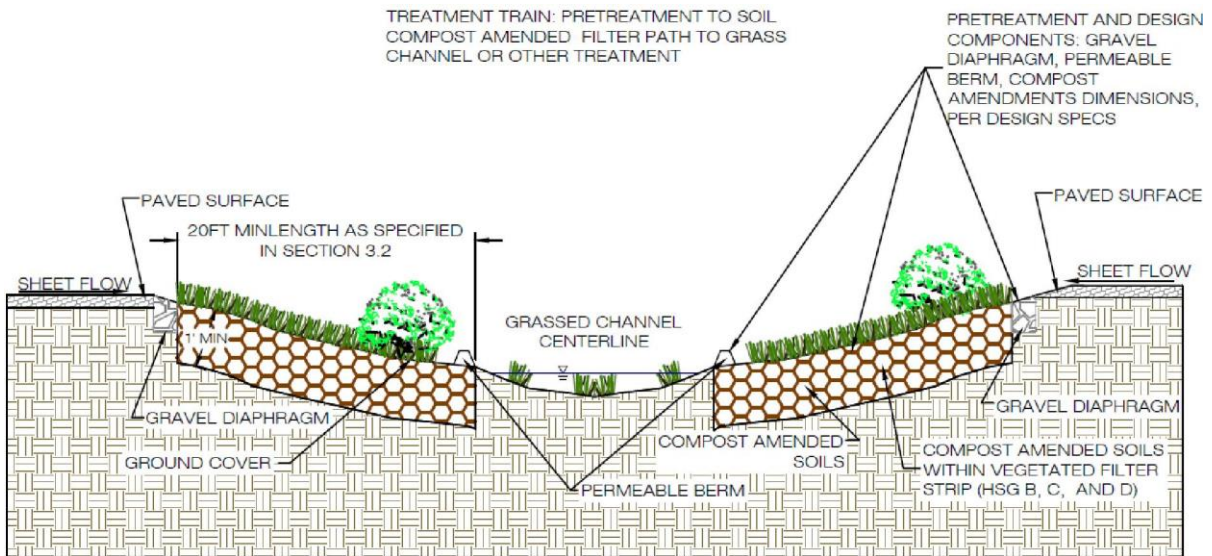
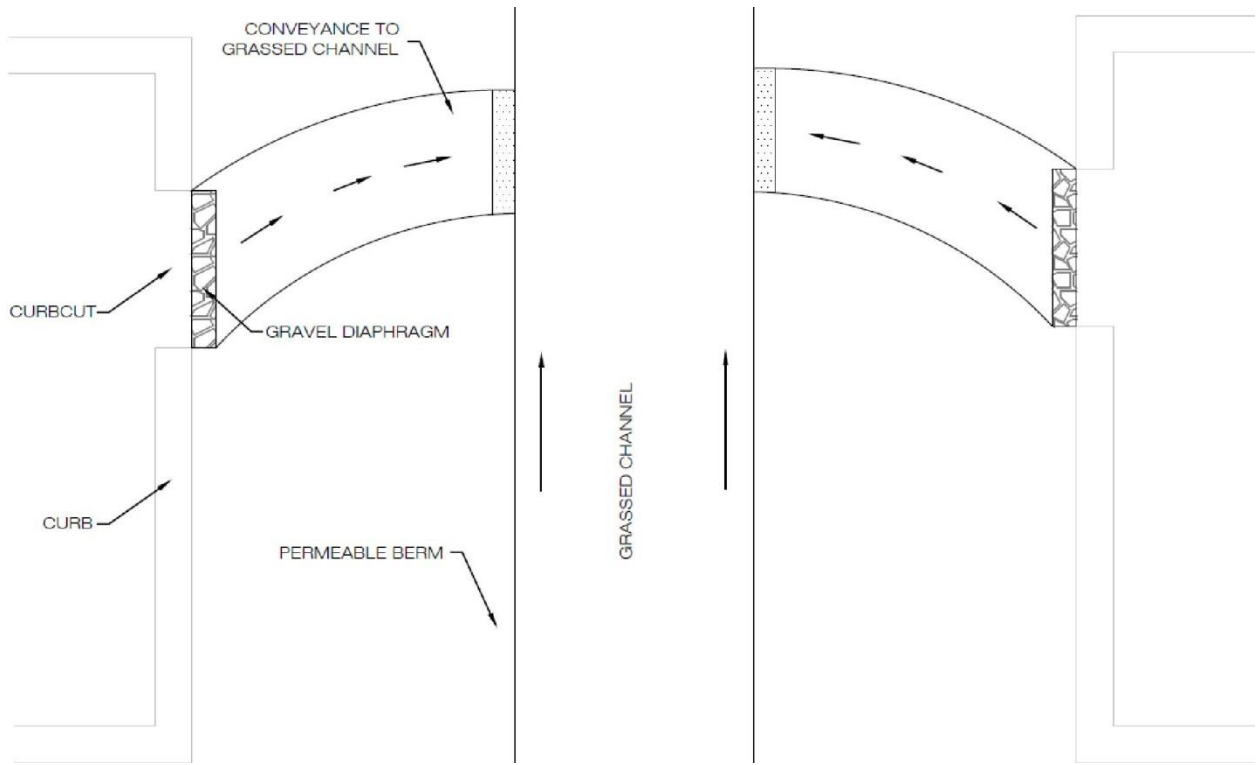


**Figure GIP-07-02. Disconnection: Soil Compost Amended Filter Path (Source: VADCR, 2011)**



**Figure GIP-07-03. Rooftop Disconnection – Section View:  
Simple Disconnection to downstream Bioretention  
(Source: VADCR, 2011)**





**Figure GIP-07-04. Amended Filter Path to Downstream Grass Channel (or other treatment)(Source: VADCR, 2011)**



## GIP -07 SECTION 4: DESIGN CRITERIA

### 4.1 Simple Rooftop Disconnection

Table GIP-07-02 provides the primary design criteria for simple rooftop disconnection.

In general:

- ❖ Simple disconnection is not credited for residential lots, except in the case of common areas within a development where the longevity and proper maintenance of the downspout disconnect can be ensured within a homeowners association's covenant.
- ❖ No more than 1,000 square feet of roof area should be discharged to any one point.
- ❖ Care should be taken to locate downspout disconnections in areas that slope away from structures. Downspouts may not be disconnected on slopes over 5%, or within 500 feet of steep slopes or landslide-prone areas.
- ❖ Simple disconnection can be used on any post-construction Hydrologic Soil Group. However, for Soil Groups C or D, alternative runoff reduction practices (e.g., compost-amended filter path, bioretention, rainwater harvesting) can boost the runoff reduction rate.
- ❖ Maintenance of disconnected downspouts usually involves normal lawn or landscaping maintenance in the filter path from the roof to the street with special attention paid to avoid potential erosion problems. In some cases, runoff from a simple disconnection may be directed to a more natural, undisturbed setting (i.e., where lot grading and clearing is "fingerprinted" and the proposed filter path is protected).

Table GIP-07-02: Simple Rooftop Disconnection Design Criteria <sup>1</sup>

DESIGN FACTOR	SIMPLE DISCONNECTION
Maximum impervious (Rooftop) area treated	1,000 sq. ft. per disconnection
Longest flow path (roof/gutter)	75 feet
Disconnection length	Equal to longest flow path, but no less than 40 feet <sup>2</sup>
Disconnection slope	< 2%, or < 5% with turf reinforcement <sup>3</sup>
Distance from buildings or foundations	Extend downspouts 5 ft. <sup>4</sup> (15 ft. in karst areas) away from building if <i>grade is less than 1%</i> .
Type of pretreatment	External (leaf screens, etc.)

<sup>1</sup> For alternative runoff reduction practices, see the applicable specification for design criteria. See Table 7.1 in this specification for eligible practices and associated specification numbers.

<sup>2</sup> An alternative runoff reduction practice must be used when the disconnection length is less than 40 feet.

<sup>3</sup> Turf reinforcement may include appropriate reinforcing materials that are confirmed by the designer to be non-erosive for the specific characteristics and flow rates anticipated at each individual application, and acceptable to the Program.

<sup>4</sup> Note that the downspout extension of 5 feet is intended for simple foundations. The use of a dry well or French drain adjacent to an in-ground basement or finished floor area should be carefully designed and coordinated with the design of the structure's water-proofing system (foundation drains, etc.), or avoided altogether.

### 1.2 Soil Compost-Amended Filter Path

The incorporation of compost amendments should conform to Appendix 8-A, and include the following design elements:



- ❖ Flow from the downspout should be spread over a 10-foot wide strip extending down-gradient along the flow path from the building to the street or conveyance system.
- ❖ The filter path should be at least 20 feet in length.
- ❖ Pea gravel or river stone diaphragm, or other accepted flow spreading device should be installed at the amended soil path inlet to distribute flows evenly across the filter path.
- ❖ The strip should be lower than the surrounding land area in order to keep flow in the filter path. Similarly, the flow area of the filter strip should be laterally level to discourage concentrating the flow down the middle of the filter path.
- ❖ Use 2 to 4 inches of compost and till to a depth of 6 to 10 inches within the filter path.

#### 4.3 Infiltration

Infiltration trenches are excavations typically filled with stone to create an underground reservoir for stormwater runoff, allowing the runoff volume to gradually exfiltrate through the bottom and sides of the trench into the subsoil over a 2-day period. By diverting runoff into the soil, infiltration trenches serve to both treat the water quality volume and to preserve the natural water balance on a site. Infiltration systems are limited to areas with highly porous soils where the water table and/or bedrock are located well below the bottom of the trench. The major design goal for Infiltration is to maximize runoff volume reduction. To this end, designers may choose to meet the requirements of a Level 1 baseline design or choose an enhanced design (Level 2) that maximizes runoff reduction, as described in **GIP-04 Infiltration Trench**.

#### 4.4 Bioretention

Providing a place for the water to soak in – such as with a compost-amended landscape area (see above), bioretention areas, or rock-filled trench – increases infiltration. Depending on soil properties, roof runoff may be filtered through a shallow bioretention area. The design for this option should meet the requirements of Bioretention as described in **GIP-01 Bioretention**.

The bioretention media is 24 to 36 inches deep, and for Level 2 may be located over a 12 inch or greater deep stone reservoir (as required by the **GIP-01**). A perforated underdrain is located above the stone reservoir, to promote storage and recharge in poorly draining soils. In urban settings, the underdrain is directly connected into the storm drain pipe running underneath the street or in the street right-of-way. A trench needs to be excavated during construction to connect the underdrain to the street storm drain system. Appropriate approvals are required for making any connections to a common (or public) drainage system.

Construction of the remainder of the front yard bioretention system is deferred until after the lot has been stabilized. The front yard design should reduce the risk of homeowner conversion because it allows the owners to choose whether they want turf or landscaping. Front yard bioretention requires regular mowing and/or landscape maintenance to perform effectively. It is recommended that the practice be located in an expanded right-of-way or stormwater easement so that it can be accessed in the event that it fails to drain properly.

#### 4.5 Rain Tanks and Cisterns

This form of disconnection must conform to the design requirements outlined in **GIP-11 Rain Tanks and Cisterns**. The runoff reduction rates for rain tanks and cisterns depend on their storage capacity and ability to draw down water in between storms for reuse as grey-water or irrigation use. The actual runoff reduction rate for a particular design can be calculated using the information provided in **GIP-11**. All devices should have a suitable overflow area to route extreme flows into the next treatment practice or the stormwater conveyance system.





#### 8.4 Stormwater Planter (Urban Bioretention)

This form of disconnection must conform to the design requirements for stormwater planters, as outlined in **GIP-02** (Urban Bioretention). Foundation planters are a useful option to disconnect and treat rooftop runoff, particularly in ultra-urban areas. They consist of confined planters that store and/or infiltrate runoff in a soil bed to reduce runoff volumes and pollutant loads. Stormwater planters combine an aesthetic landscaping feature with a functional form of stormwater treatment. Stormwater planters generally receive runoff from adjacent rooftop downspouts and are landscaped with plants that are tolerant to periods of both drought and inundation. The two basic design variations for stormwater planters are the infiltration planter and the filter planter.

An **infiltration planter** filters rooftop runoff through soil in the planter followed by infiltration into soils below the planter. The recommended minimum depth is 30 inches, with the shape and length determined by architectural considerations. The planter should be sized to temporarily store at least 0.5 inch of runoff from the contributing rooftop area in a reservoir above the planter bed. Infiltration planters should be placed at least 10 feet away from a building to prevent possible flooding or basement seepage damage.

A **filter planter** has an impervious liner on the bottom. The minimum planter depth is 30 inches, with the shape and length determined by architectural considerations. Runoff is temporarily stored in a reservoir located above the planter bed. Overflow pipes are installed to discharge runoff when maximum ponding depths are exceeded, to avoid water spilling over the side of the planter. In addition, an underdrain is used to carry runoff to the storm sewer system. Since a filter planter is self-contained and does not infiltrate into the ground, it can be installed right next to a building.

All planters should be placed at grade level or above ground. They should be sized to allow captured runoff to drain out within four hours after a storm event. Plant materials should be capable of withstanding seasonally moist and dry conditions. Planting media should have an infiltration rate of at least 2 inches per hour. The sand and gravel on the bottom of the planter should have a minimum infiltration rate of 5 inches per hour. The planter can be constructed of stone, concrete, brick, wood or other durable material. If treated wood is used, care should be taken so that trace metals and creosote do not leach out of the planter.

### GIP – 07 SECTION 5: MAINTENANCE

Each BMP must have a Hamilton County Water Quality Stormwater Management Facility I&M Storm Water Management Facilities Agreement submitted for approval and maintained and updated by the BMP owner. The Stormwater Management Facilities I&M Agreement must be completed and submitted to the Program with the Land Disturbance permit application. The Stormwater Management Facilities I&M Agreement is for the use of the BMP owner in performing routine inspections. The developer/owner is responsible for the cost of maintenance and annual inspections. The BMP owner must maintain and update the BMP inspection and maintenance plan.

### GIP – 07 SECTION 6: AS-BUILT REQUIREMENTS

After the downspout disconnection has been constructed, the developer must have an as-built certification conducted by a registered Professional Engineer. The as-built certification verifies that the BMP was installed as designed and approved.

The following components must be addressed in the as-built certification:

1. Ensure disconnect is treating appropriate area size from either sheet flow or roof leader.



2. Ensure filter media depth is properly sized.
3. Ensure building setbacks are 5 ft. down-gradient, 25 ft. up-gradient.
4. Ensure underdrain and gravel layer (if required) have been properly installed.
5. If alternative practices have been utilized, insure that as-built requirements for those GIPs are also certified using as-built section of the utilized GIP.

## GIP – 07 SECTION 7: REFERENCES

Chesapeake Stormwater Network (CSN). 2008. *Technical Bulletin 1: Stormwater Design Guidelines for Karst Terrain in the Chesapeake Bay Watershed*. Version 1.0. Baltimore, MD. **Available online at:** <http://www.chesapeakestormwater.net/all-things-stormwater/stormwater-guidance-for-karst-terrain-in-the-chesapeake-bay.html>

Stormwater Management Program. January 2014. *City of Franklin Stormwater Best Management Practices Manual*, City of Franklin.

City of Portland, Environmental Services. 2004. *Portland Stormwater Management Manual*. Portland, OR. <http://www.portlandonline.com/bes/index.cfm?c=dfbbh>

CWP. 2007. *National Pollutant Removal Performance Database Version 3.0*. Center for Watershed Protection, Ellicott City, MD.

Northern Virginia Regional Commission. 2007. *Low Impact Development Supplement to the Northern Virginia BMP Handbook*. Fairfax, Virginia.

*Philadelphia Stormwater Management Guidance Manual*. Available online at: <http://www.phillyriverinfo.org/Programs/SubprogramMain.aspx?Id=StormwaterManual>

Schueler, T., D. Hirschman, M. Novotney and J. Zielinski. 2007. *Urban stormwater retrofit practices*. Manual 3 in the Urban Subwatershed Restoration Manual Series. Center for Watershed Protection, Ellicott City, MD.

Schueler, T. 2008. Technical Support for the Baywide Runoff Reduction Method. Chesapeake Stormwater Network. Baltimore, MD. [www.chesapeakestormwater.net](http://www.chesapeakestormwater.net)

VADCR. 2011. Stormwater Design Specification No. 1: Rooftop (Impervious Surface) Disconnection, Version 1.9, March 1, 2011. Virginia Department of Conservation and Recreation. Available at: <http://vwrrc.vt.edu/swc/NonProprietaryBMPs.html>.



## GIP – 07 APPENDIX A DESIGN CRITERIA FOR AMENDING SOILS WITH COMPOST

### SECTION 1: DESCRIPTION

Soil restoration is a practice applied after construction, to deeply till compacted soils and restore their porosity by amending them with compost. These soil amendments can reduce the generation of runoff from compacted urban lawns and may also be used to enhance the runoff reduction performance of downspout disconnections, grass channels, and filter strips.

### SECTION 2: PHYSICAL FEASIBILITY & DESIGN APPLICATIONS

Compost amended soils are suitable for any pervious area where soils have been or will be compacted by the grading and construction process. They are particularly well suited when existing soils have low infiltration rates (HSG C and D) and when the pervious area will be used to filter runoff (downspout disconnections and grass channels). The area or strip of amended soils should be hydraulically connected to the stormwater conveyance system. Soil restoration is recommended for sites that will experience mass grading of more than a foot of cut and fill across the site.

Compost amendments are not recommended where:

- ❖ Existing soils have high infiltration rates (e.g., HSG A and B); although compost amendments may be needed at mass-graded B soils in order to maintain runoff reduction rates.
- ❖ The water table or bedrock is located within 1.5 feet of the soil surface.
- ❖ Slopes exceed 10%.
- ❖ Existing soils are saturated or seasonally wet.
- ❖ They would harm roots of existing trees (keep amendments outside the tree drip line).
- ❖ The downhill slope runs toward an existing or proposed building foundation.
- ❖ The contributing impervious surface area exceeds the surface area of the amended soils.

Compost amendments can be applied to the entire pervious area of a development or be applied only to select areas of the site to enhance the performance of runoff reduction practices. Some common design applications include:

- ❖ Reduce runoff from compacted lawns.
- ❖ Enhance rooftop disconnections on poor soils.
- ❖ Increase runoff reduction within a grass channel.
- ❖ Increase runoff reduction within a vegetated filter strip.
- ❖ Increase the runoff reduction function of a tree cluster or reforested area of the site.

### SECTION 3: DESIGN CRITERIA

#### 3.1 Soil Testing

Soil tests are required during two stages of the compost amendment process. The first testing is done to ascertain pre-construction soil properties at proposed amendment areas. The initial testing is used to determine soil properties to a depth 1 foot below the proposed amendment area, with respect to bulk density, pH, salts, and soil nutrients. These tests should be conducted every 5000 square feet, and are used to characterize potential drainage problems and determine what, if any, further soil amendments are needed.





The second soil test is taken at least one week after the compost has been incorporated into the soils. This soil analysis should be conducted by a reputable laboratory to determine whether any further nutritional requirements, pH adjustment, and organic matter adjustments are necessary for plant growth. This soil analysis should be done in conjunction with the final construction inspection to ensure tilling or subsoiling has achieved design depths.

### 3.2 Determining Depth of Compost Incorporation

The depth of compost amendment is based on the relationship of the surface area of the soil amendment to the contributing area of impervious cover that it receives. Table 7-A.1 presents some general guidance derived from soil modeling by Holman-Dodds (2004) that evaluates the required depth to which compost must be incorporated. Some adjustments to the recommended incorporation depth were made to reflect alternative recommendations of Roa Espinosa (2006), Balousek (2003), Chollak and Rosenfeld (1998) and others.

Table 7-A.1. Short-Cut Method to Determine Compost and Incorporation Depths				
	Contributing Impervious Cover to Soil Amendment Area Ratio <sup>1</sup>			
	IC/SA = 0 <sup>2</sup>	IC/SA = 0.5	IC/SA = 0.75	IC/SA = 1.0 <sup>3</sup>
Compost (in) <sup>4</sup>	2 to 4 <sup>5</sup>	3 to 6 <sup>5</sup>	4 to 8 <sup>5</sup>	6 to 10 <sup>5</sup>
Incorporation Depth (in)	6 to 10 <sup>5</sup>	8 to 12 <sup>5</sup>	15 to 18 <sup>5</sup>	18 to 24 <sup>5</sup>
Incorporation Method	Rototiller	Tiller	Subsoiler	Subsoiler

<sup>1</sup> IC = contrib. impervious cover (sq. ft.) and SA = surface area of compost amendment (sq. ft.)

<sup>2</sup> For amendment of compacted lawns that do not receive off-site runoff

<sup>3</sup> In general, IC/SA ratios greater than 1 should be avoided

<sup>4</sup> Average depth of compost added

<sup>5</sup> Lower end for B soils, higher end for C/D soils

Once the area and depth of the compost amendments are known, the designer can estimate the total amount of compost needed using the following estimator equation:

#### Equation 7.1. Compost Quantity Estimation

$$C = A * D * 0.0031$$

Where:

C = compost needed (cu. yds.)

A = area of soil amended (sq. ft.)

D = depth of compost added (in.)

### 3.3 Compost Specifications

The basic material specifications for compost amendments are outlined below:

- ❖ Compost shall be derived from plant material and provided by a member of the U.S. Composting Seal of Testing Assurance (STA) program. See [www.compostingcouncil.org](http://www.compostingcouncil.org) for a list of local providers.
- ❖ The compost shall be the result of the biological degradation and transformation of plant-derived materials under conditions that promote anaerobic decomposition. The material shall be well composted, free of viable weed seeds, and stable with regard to oxygen consumption and carbon dioxide generation. The compost shall have a moisture content that has no visible free water or dust produced when handling the



material. It shall meet the following criteria, as reported by the U.S. Composting Council STA Compost Technical Data Sheet provided by the vendor:

- a. 100% of the material must pass through a half inch screen
- b. The pH of the material shall be between 6 and 8
- c. Manufactured inert material (plastic, concrete, ceramics, metal, etc.) shall be less than 1.0% by weight
- d. The organic matter content shall be between 35% and 65%
- e. Soluble salt content shall be less than 6.0 mmhos/cm
- f. Maturity should be greater than 80%
- g. Stability shall be 7 or less
- h. Carbon/nitrogen ratio shall be less than 25:1
- i. Trace metal test result = "pass"
- j. The compost must have a dry bulk density ranging from 40 to 50 lbs./cu.ft.

## SECTION 4: CONSTRUCTION

### 4.1 Construction Sequence

The construction sequence for compost amendments differs depending on whether the practice will be applied to a large area or a narrow filter strip, such as in a rooftop disconnection or grass channel. For larger areas, a typical construction sequence is as follows:

**Step 1.** Prior to building, the proposed area should be deep tilled to a depth of 2 to 3 feet using a tractor and sub-soiler with two deep shanks (curved metal bars) to create rips perpendicular to the direction of flow. (This step is usually omitted when compost is used for narrower filter strips.)

**Step 2.** A second deep tilling to a depth of 12 to 18 inches is needed after final building lots have been graded.

**Step 3.** It is important to have dry conditions at the site prior to incorporating compost.

**Step 4.** An acceptable compost mix is then incorporated into the soil using a roto-tiller or similar equipment at the volumetric rate of 1 part compost to 2 parts soil.

**Step 5.** The site should be leveled and seeds or sod used to establish a vigorous grass cover. Lime or irrigation may initially be needed to help the grass grow quickly.

**Step 6.** Areas of compost amendments exceeding 2,500 square feet should employ simple erosion control measures, such as silt fence, to reduce the potential for erosion and trap sediment.

### 4.2 Construction Inspection

Construction inspection involves digging a test pit to verify the depth of mulch, amended soil and scarification. A rod penetrometer should be used to establish the depth of uncompacted soil at one location per 10,000 square feet.

## SECTION 5: REFERENCES

Balousek. 2003. *Quantifying decreases in stormwater runoff from deep-tilling, chisel-planting and compost amendments*. Dane County Land Conservation Department. Madison, Wisconsin.



Chollak, T. and P. Rosenfeld. 1998. *Guidelines for Landscaping with Compost-Amended Soils*. City of Redmond Public Works. Redmond, WA. Available online at: <http://www.ci.redmond.wa.us/insidcityhall/publicworks/environment/pdfs/compostamendedsoils.pdf>

City of Franklin, Stormwater Management Program. January 2014. *City of Franklin Stormwater Best Management Practices Manual*.

City of Portland. 2008. "Soil Specification for Vegetated Stormwater Facilities." *Portland Stormwater Management Manual*. Portland, Oregon.

Composting Council (TCC). 1997. *Development of a Landscape Architect Specification for Compost Utilization*. Alexandria, VA. <http://www.cwc.org/organics/org972rpt.pdf>

Holman-Dodds, L. 2004. *Chapter 6. Assessing Infiltration-Based Stormwater Practices*. PhD Dissertation. Department of Hydroscience and Engineering. University of Iowa. Iowa City, IA.

Lenhart, J. 2007. "Compost as a Soil Amendment for Water Quality Treatment Facilities." *Proceedings: 2007 LID Conference*. Wilmington, NC.

Low Impact Development Center. *Guideline for Soil Amendments*. Available online at: <http://www.lowimpactdevelopment.org/epa03/soilamend.htm>

Roa-Espinosa. 2006. *An Introduction to Soil Compaction and the Subsoiling Practice. Technical Note*. Dane County Land Conservation Department. Madison, Wisconsin.

Soils for Salmon. 2003. *Soil Restoration and Compost Amendments*. Available online at: <http://www.soilsforsalmon.org/pdf/SoilsforSalmonLIDrev9-16-04.pdf>





## Grass Channel



GIP - 08

Hamilton County



Water Quality Program

**Description:** Limited application structural control intended for small drainage areas. Open channels that are vegetated and are designed to filter stormwater runoff through settling and biological uptake mechanisms, as well as to slow water for treatment by another structural control.

### Components:

- Broad bottom channel on gentle slopes (4% or less)
- Gentle side slopes (3:1 (H:V) or less)
- Dense vegetation that assists in stormwater filtration
- Check dams can be installed to maximize treatment

### Advantages/Benefits:

- Provides pretreatment if used as part of runoff conveyance system
- Provides partial infiltration of runoff in pervious soils
- Cost effective – less expensive than curb and gutter
- Good for small drainage areas
- Wildlife habitat potential

### Disadvantages/Limitations:

- Potential for thermal impacts downstream
- Must be carefully designed to achieve low, non-erosive flow rates in the channel
- May re-suspend sediment
- May not be acceptable for some areas due to standing water in channels

### Design considerations:

- Maximum drainage area of 5 acres
- Requires slopes of 4% or flatter
- Runoff velocities must be non-erosive
- Appropriate for all but the most impermeable soils
- Requires vegetation that can withstand both relatively high velocity flows and wet and dry periods
- Generally used in conjunction with downstream practices to increase runoff reduction
- Will not receive additional runoff reduction credit if more than one grass channel is used in a series

### Selection Criteria:

#### Runoff Reduction Removal Credit:

Level 1 – 10 - 20% for HSG soils C and D

Level 2 – 20 - 30% for HSG Soils A and B

#### Land Use Considerations:

- Residential
- Commercial
- Industrial (with approval)

### Maintenance:

- Monitor sediment accumulation and periodically clean out
- Inspect for and correct formation of rills and gullies
- Remove debris from inlet and outlet structures
- Maintain side slopes/remove invasive vegetation
- Ensure that vegetation is well-established

**Maintenance Burden**  
 L = Low M = Moderate H = High



## GIP – 08 SECTION 1. DESCRIPTION

Grass channels are conveyance channels that are designed to provide some treatment of runoff, as well as to slow down runoff velocities for treatment in other structural controls. Grass channels are appropriate for a number of applications including treating runoff from paved roads and from other impervious areas.

Grass channels can provide a modest amount of runoff filtering and volume attenuation within the stormwater conveyance system resulting in the delivery of less runoff and pollutants than a traditional system of curb and gutter, storm drain inlets and pipes. The performance of grass channels will vary depending on the underlying soil permeability as shown in **Table GIP-08-01**. Grass channels, however, are not capable of providing the same stormwater functions as water quality swales as they lack the storage volume associated with the engineered soil media. Their runoff reduction performance can be increased when compost amendments are added to the bottom of the swale (See GIP-07 **Appendix A, Downspout Disconnection GIP-07**). Grass channels are a preferable alternative to both curb and gutter and storm drains as a stormwater conveyance system, where development density, topography and soils permit.

## GIP – 08 SECTION 2. PERFORMANCE

Stormwater Function	Level 1 HSG Soils C and D		Level 2 HSG Soils A and B	
	No CA <sup>2</sup>	With CA	No CA <sup>2</sup>	With CA <sup>3</sup>
<b>Runoff Volume Reduction (RR)</b>	10%	20%	20%	30% <sup>3</sup>

CSN (2008) and CWP (2007).

<sup>2</sup> CA= Compost Amended Soils, see GIP-07.

<sup>3</sup> Compost amendments are generally not applicable for A and B soils, although it may be advisable to incorporate them on mass-graded and/or excavated soils to maintain runoff reduction rates. In these cases, the 30% runoff reduction rate may be claimed, regardless of the pre-construction HSG.

## GIP – 08 SECTION 3: DESIGN TABLE

Grass channels must meet the minimum criteria outlined in **Table 8.2** to qualify for the indicated level of runoff reduction.

Design Criteria
The bottom width of the channel should be between 4 to 8 feet wide.
The channel side-slopes should be 3H:1 V or flatter.
The maximum total contributing drainage area to any individual grass channel is 5 acres.
The longitudinal slope of the channel should be no greater than 4%.
Check dams may be used to increase residence time.
The maximum flow velocity of the channel must be less than 1 foot per second during a 1-inch storm event.
The dimensions of the channel should ensure that flow velocity is non-erosive during the 2-year and 10-year design storm events and the 10-year design flow is contained within the channel (minimum of 6 inches of freeboard).
The vegetation used should be hardy and able to withstand relatively high velocities as well as a range of moisture conditions from very wet to dry.



### GIP – 08 SECTION 4: TYPICAL DETAILS

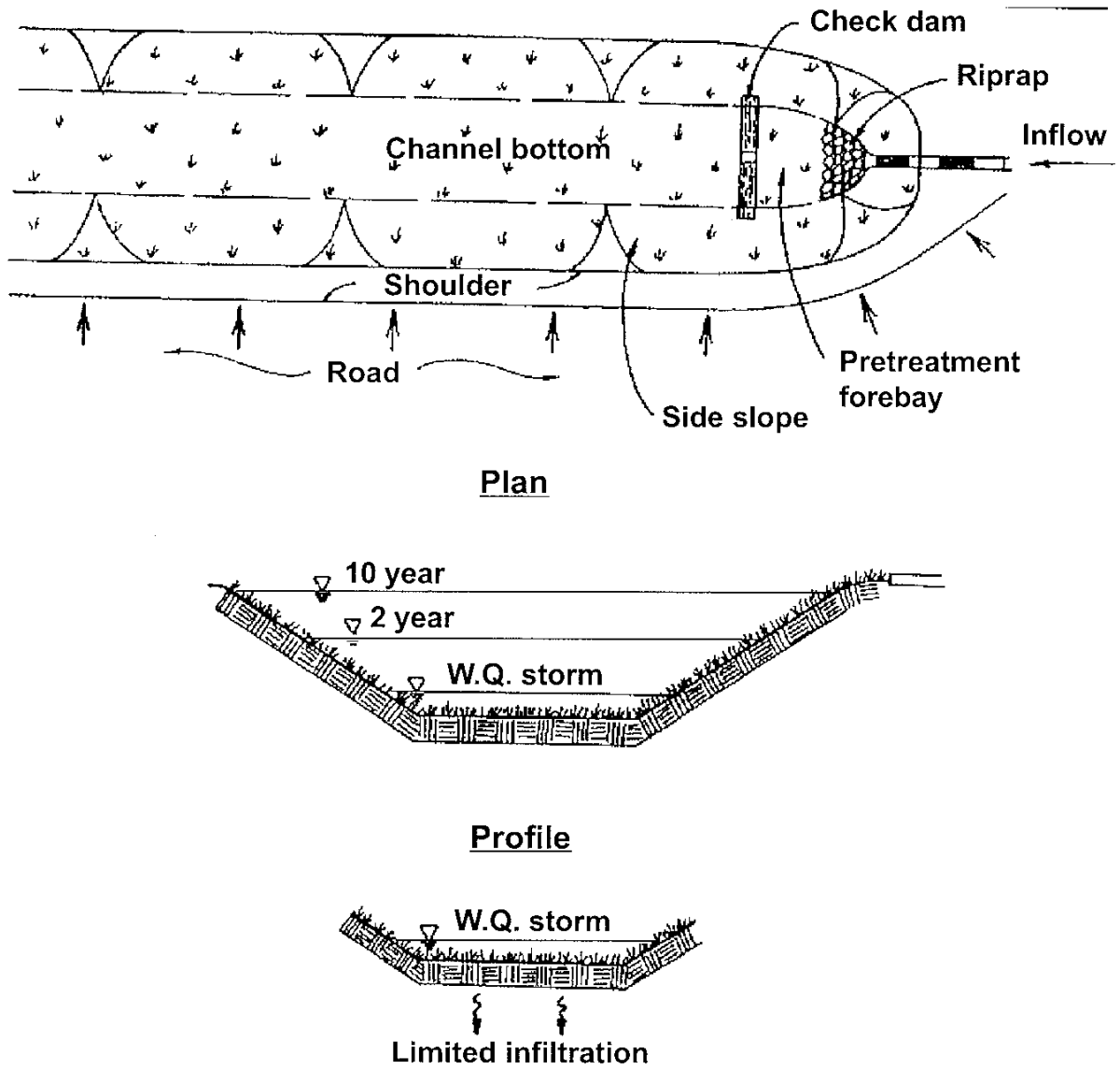


Figure GIP-08-01. Grass Channel – Typical Plan, Profile and Section



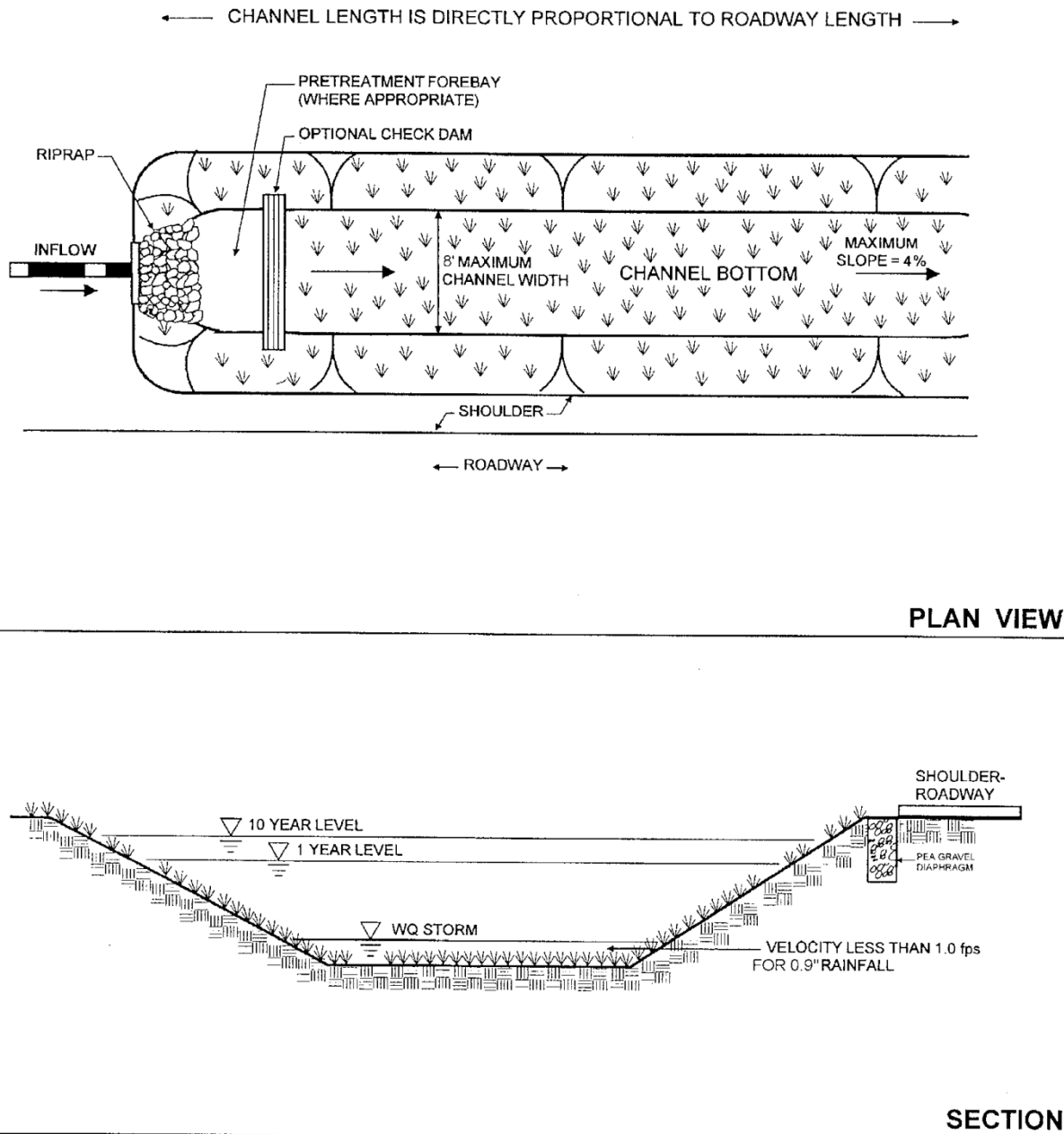
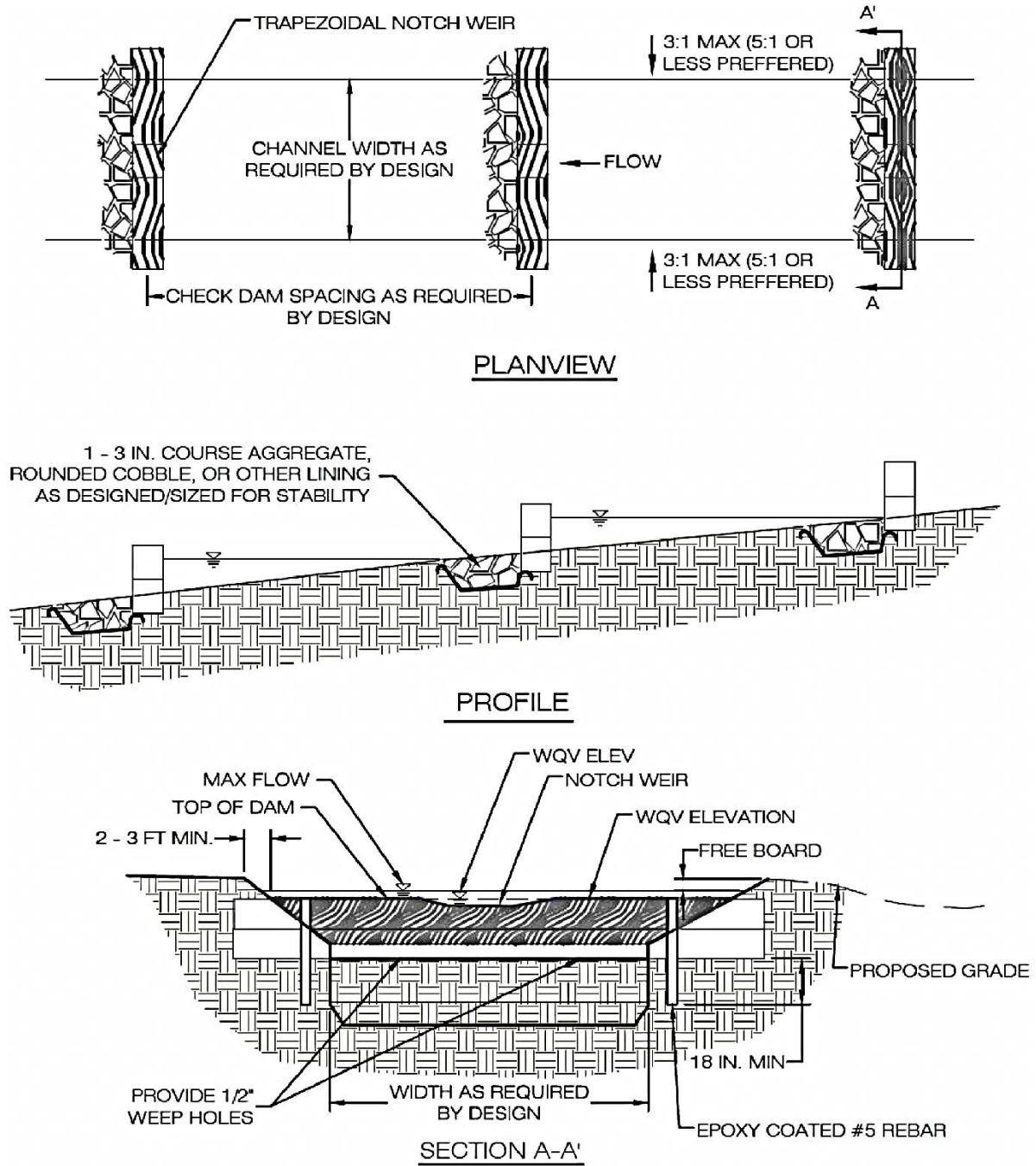


Figure GIP-08-02. Grass Channel along Roadway – Typical Plan, Profile and Section  
 (Source: VADCR, 2011)



NOTE: CHECK DAM CONSTRUCTED OF RAILROAD TIES, PRESSURE TREATED LOGS OR TIMBERS, OR CONCRETE.

Figure GIP -08-03 Grass Channel with Check Dams – Typical Plan, Profile, and Section

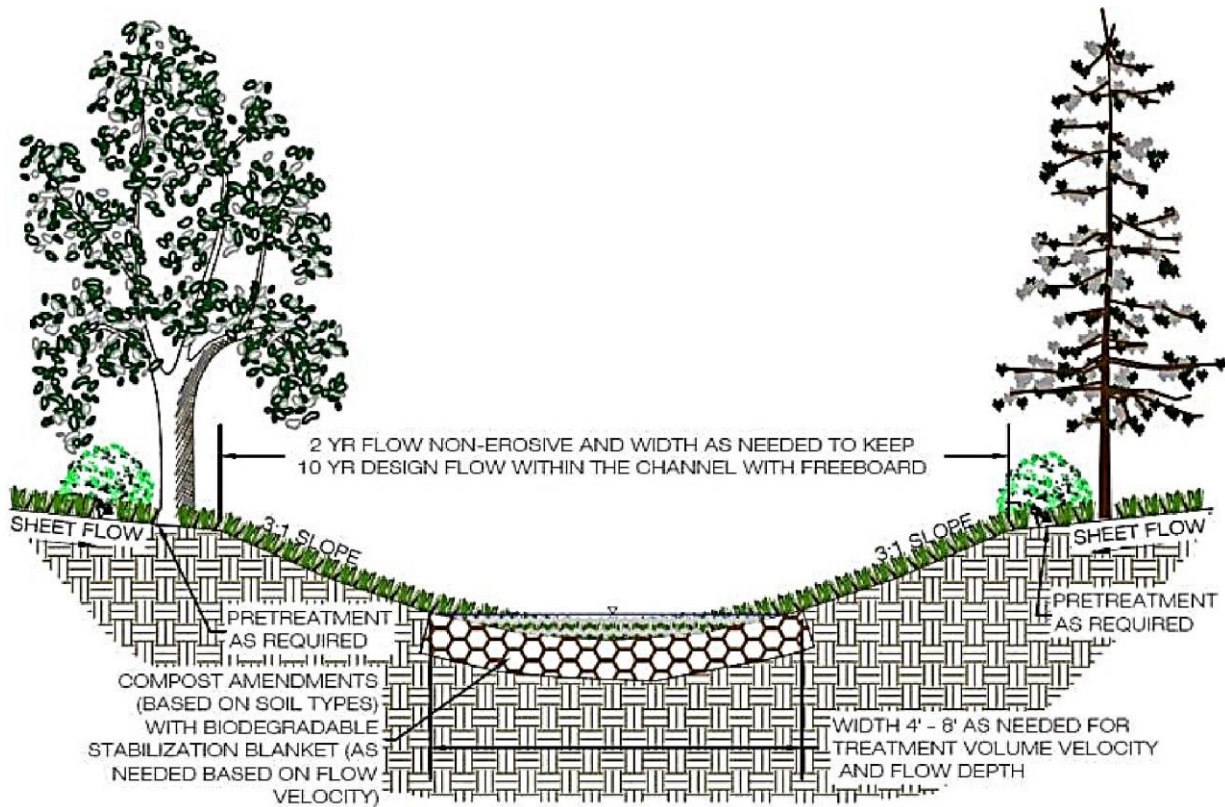


Figure GIP-08-04: Grass Channel with Compost Amendments - Section

## GIP – 08 SECTION 5: PHYSICAL FEASIBILITY AND DESIGN APPLICATIONS

Grass channels can be implemented on development sites where development density, topography and soils are suitable. The linear nature of grass channels makes them well-suited to treat highway runoff, low and medium density residential road runoff and small commercial parking areas or driveways. However, a **Water Quality Swale (GIP-05)** will provide much greater runoff reduction and pollutant removal performance.

Key constraints for grass channels include:

**Land Uses.** Grass channels can be used in residential, commercial or institutional development settings. However, when grass channels are used for both conveyance and water quality treatment, they should be applied only in linear configurations parallel to the contributing impervious cover, such as roads and small parking areas. Grass channels within the right of way will only receive credit for treating stormwater generated within the right of way.

- ❖ Large commercial site applications may require multiple channels in order to effectively break up the drainage areas and meet the design criteria.
- ❖ The linear nature of grass channels makes them well suited to treat highway or low- and medium-density residential road runoff, if there is adequate right of way width and distance between driveways.





**Contributing Drainage Area.** The drainage area (contributing or effective) to a grass channel must be 5 acres or less. When grass channels treat and convey runoff from drainage areas greater than 5 acres, the velocity and flow depth through the channel becomes too great to treat runoff or prevent channel erosion.

**Available Space.** Grass channels can be incorporated into linear development applications (e.g., roadways) by utilizing the footprint typically required for an open section drainage feature. The footprint required will likely be greater than that of a typical conveyance channel (TDOT or equivalent). However, the benefit of the runoff reduction may reduce the footprint requirements for stormwater management elsewhere on the development site.

**Longitudinal Slope.** Grass channels should be designed on areas with slopes of less than 4%. Slopes steeper than 4% create rapid runoff velocities that can cause erosion and do not allow enough contact time for infiltration or filtering, unless check dams are used. Slopes of 1-2% are recommended, and slopes of less than 2% may eliminate the need for check dams. Channels designed with longitudinal slopes of less than 1% should be monitored carefully during construction to ensure a continuous grade, in order to avoid flat areas with pockets of standing water.

**Soils.** Grass channels can be used on most soils with some restrictions on the most impermeable soils. Grass channels situated on Hydrologic Soil Group C and D soils will require compost amendments in order to improve performance. Grass channels should not be used on soils with infiltration rates 0.5 inches per hour or less if infiltration of small runoff flow is intended.

**Hydraulic Capacity.** Grass channels are an on-line practice and must be designed with enough capacity to convey runoff from the 10-year design storm event within the channel banks and be non-erosive during both the 2-year and 10-year design storm events. This means that the much of the surface dimensions are driven by the need to pass these larger storm events. Larger flows should be accommodated by the channel if dictated by the surrounding conditions. For instance, the Program recommends site drainage to accommodate the 10-year design storm. The channel should accommodate the 2-year, 24-hour storm without eroding.

**Depth to Water Table.** Designers should ensure that the bottom of the grass channel is at least 2 feet above the seasonally high water table to prevent a moist swale bottom and ensure that groundwater does not intersect the filter bed and possibly lead to groundwater contamination or practice failure.

**Utilities.** Designers should consult local utility design guidance for the horizontal and vertical clearance between utilities and the channels. Typically, utilities can cross grass channels if they are specially protected (e.g., double-casing) or are located below the channel invert. Tennessee One Call (811) should be contacted before digging onsite begins.

**Minimum Setbacks.** Grass channels should be set back at least 10 feet down-gradient from building foundations, 50 feet from septic system fields and 100 feet from private wells.

## GIP – 08 SECTION 6: DESIGN CRITERIA

### 6.1 Sizing of Grass Channels

Unlike other stormwater practices, grass channels are designed based on a peak rate of flow. Designers must demonstrate channel conveyance and treatment capacity in accordance with the following guidelines:



- ❖ The longitudinal slope of the channel should ideally be between 1% and 2% in order to avoid scour and short-circuiting within the channel. Longitudinal slopes up to 4% are acceptable; however, check dams will likely be required in order to meet the allowable maximum flow velocities.
- ❖ A minimum residence time of five minutes is required.
  - Hydraulic capacity should be verified using Manning’s Equation or an accepted equivalent method, such as erodibility factors and vegetal retardance.
  - The Flow Depth for the peak treatment volume should be maintained at 3 inches or less.
  - Manning’s “n” value for grass channels should be 0.2 for flow depths up to 4 inches, decreasing to 0.03 at a depth of 12 inches (which would apply to the 2-year and 10-year storms if an on-line application – NOVA, 2007; Haan et. al, 1994).
  - Peak Flow Rates for the 2-year and 10-year frequency storms must be non-erosive, and the 10-year peak flow rate must be contained within the channel banks (with a minimum of 6 inches of freeboard).
- ❖ Larger flows should be accommodated by the channel if dictated by the surrounding conditions. For instance, the Program recommends site drainage to accommodate the 10-year design storm.
- ❖ Calculations for peak flow depth and velocity should reflect any increase in flow along the length of the channel, as appropriate. If a single flow is used, the flow at the outlet should be used.
- ❖ The minimum length may be achieved with multiple swale segments connected by culverts with energy dissipaters.

Table GIP-08-03: Maximum Permissible Velocities for Grass Channels		
Cover Type	Erosion Resistant Soils (ft./sec.)	Easily Eroded Soils (ft./sec.)
Bermuda grass	6	4.5
Kentucky bluegrass Tall fescue	5	3.8
Grass-legume mixture	4	3
Kentucky blue grass Tall fescue	3	2.3
Red fescue	2.5	1.9

Sources: VADCR (1992), Ree (1949), Temple et al (1987)

## 6.2 Geometry and Site Layout

- ❖ Grass channels should generally be aligned adjacent to and the same length (minimum) as the contributing drainage area identified for treatment.
- ❖ Grass channels should be designed with a trapezoidal or parabolic cross section with relatively flat side slopes. A parabolic shape is preferred for aesthetic, maintenance and hydraulic reasons.
- ❖ The bottom width of the channel should be between 2 to 8 feet wide. If a channel will be wider than 8 feet, the designer should incorporate benches, check dams, level spreaders or multi-level cross sections to prevent braiding and erosion along the channel bottom. The bottom width is a dependent variable in the calculation of velocity based on Manning’s equation. If a larger channel is needed, the use of a compound cross section is recommended.
- ❖ Grass channel side slopes should be no steeper than 3 H:1 V for ease of mowing and routine maintenance. Flatter slopes are encouraged, where adequate space is available, to aid in pretreatment of sheet flows entering the channel.



### 6.3 Check dams

Check dams may be used for pre-treatment, to break up slopes, and to increase the hydraulic residence time in the channel. Design requirements for check dams are as follows:

- ❖ Check dams should be spaced based on the channel slope, as needed to increase residence time, provide  $T_v$  storage volume, or any additional volume attenuation requirements. The ponded water at a downhill check dam should not touch the toe of the upstream check dam.
- ❖ The maximum desired check dam height is 12 inches (for maintenance purposes). The average ponding depth throughout the channel should be 12 inches.
- ❖ Armoring may be needed at the downstream toe of the check dam to prevent erosion.
- ❖ Check dams must be firmly anchored into the side-slopes to prevent outflanking; check dams must also be anchored into the channel bottom so as to prevent hydrostatic head from pushing out the underlying soils.
- ❖ Check dams must be designed with a center weir sized to pass the channel design storm peak flow (10-year storm event for man-made channels).
- ❖ The check dam should be designed so that it facilitates easy mowing.
- ❖ Each check dam should have a weep hole or similar drainage feature so it can dewater after storms.
- ❖ Check dams should be composed of wood, concrete, stone, or other non-erodible material, or should be configured with elevated driveway culverts.
- ❖ Individual channel segments formed by check dams or driveways should generally be at least 25 to 40 feet in length.

### 6.4 Compost Soil Amendments

Soil compost amendments serve to increase the runoff reduction capability of a grass channel. The following design criteria apply when compost amendments are used:

- ❖ The compost-amended strip should extend over the length and width of the channel bottom, and the compost should be incorporated to a depth as outlined in **Appendix A of GIP-07 – Downspout Disconnection**.
- ❖ The amended area will need to be rapidly stabilized with grass.
- ❖ Depending on the slope of the channel, it may be necessary to install a protective biodegradable geotextile fabric to protect the compost-amended soils. Care must be taken to consider the erosive characteristics of the amended soils when selecting an appropriate geotextile.
- ❖ For redevelopment or retrofit applications, the final elevation of the grass channel (following compost amendment) must be verified as meeting the original design hydraulic capacity.

### 6.5 Planting Grass Channels

Designers should choose grass species that can withstand both wet and dry periods as well as relatively high-velocity flows within the channel. For applications along roads and parking lots, salt tolerant species should be chosen. Taller and denser grasses are preferable, though the species of grass is less important than good stabilization.

Grass channels should be seeded at such a density to achieve a 90 % turf cover after the second growing season. Performance has been shown to fall rapidly as vegetative cover falls below 80%. Grass channels should be seeded and not sodded. Seeding establishes deeper roots and sod may have muck soil that is not conducive to infiltration (Storey et. al., 2009). Grass channels should be protected by a biodegradable erosion control fabric to provide immediate stabilization of the channel bed and banks.





## 6.6 Grass Channel Material Specifications

The basic material specifications for grass channels are outlined in **Table GIP-08-04** below.

Table GIP-08-04. Grass Channel Materials Specifications	
Component	Specification
Grass	A dense cover of water-tolerant, erosion-resistant grass. The selection of an appropriate species or mixture of species is based on several factors including climate, soil type, topography and sun or shade tolerance. Grass species should have the following characteristics: a deep root system to resist scouring; a high stem density with well-branched top growth; water-tolerance; resistance to being flattened by runoff; an ability to recover growth following inundation; and, if receiving runoff from roadways, salt-tolerance.
Check Dams	<ul style="list-style-type: none"> <li>• Check dams should be constructed of a non-erosive material such as wood, gabions, riprap or concrete. All check dams should be underlain with filter fabric conforming to local design standards.</li> <li>• Wood used for check dams should consist of pressure treated logs or timbers, or water-resistant tree species such as cedar, hemlock, swamp oak or locust.</li> <li>• Computation of check dam material is necessary, based on the surface area and depth used in the design computations. (See <a href="http://vwrrc.vt.edu/swc/NonPBMPSpecsMarch11/Introduction_App%20Earthen%20Embankments_SCraftonRev_03012011.pdf">http://vwrrc.vt.edu/swc/NonPBMPSpecsMarch11/Introduction_App%20Earthen%20Embankments_SCraftonRev_03012011.pdf</a> ).</li> </ul>
Diaphragm	Pea gravel used to construct pre-treatment diaphragms should consist of washed, open-graded, coarse aggregate between 3 and 10 mm in diameter and must conform to local design standards.
Erosion Control Fabric	Where flow velocities dictate, biodegradable erosion control netting or mats that are durable enough to last at least two growing seasons must be used.
Filter Fabric (check dams)	Needled, non-woven, polypropylene geotextile meeting the following specifications: Grab Tensile Strength (ASTM D4632): > 120 lbs. Mullen Burst Strength (ASTM D3786): > 225 lbs./sq. in. Flow Rate (ASTM D4491): > 125 gpm/sq. ft. Apparent Opening Size (ASTM D4751): US #70 or #80 sieve

## GIP – 08 SECTION 7: SPECIAL CASE DESIGN ADAPTATIONS

### 7.1 Steep Terrain

Grass swales are not practical in areas of steep terrain, although terracing a series of grass swale cells may work on slopes from 5% to 10%. The drop in elevation between check dams should be limited to 18 inches in these cases, and the check dams should be armored on the down-slope side with suitably sized stone to prevent erosion.



## GIP – 08 SECTION 8: CONSTRUCTION

### 8.1 Construction Sequence

The following is a typical construction sequence to properly install a grass channel, although steps may be modified to reflect different site conditions. Grass channels should be installed at a time of year that is best to establish turf cover without irrigation.

**Step 1: Protection during Site Construction.** Ideally, grass channels should remain outside the limit of disturbance during construction to prevent soil compaction by heavy equipment. However, this is seldom practical, given that the channels are a key part of the drainage system at most sites. In these cases, temporary EPSC such as dikes, silt fences and other erosion control measures should be integrated into the swale design throughout the construction sequence. Specifically, barriers should be installed at key check dam locations, and erosion control fabric should be used to protect the channel.

**Step 2.** Grass channel installation may only begin after the entire contributing drainage area has been stabilized with vegetation. Any accumulation of sediments that does occur within the channel must be removed during the final stages of grading to achieve the design cross-section. EPSC for construction of the grass channel should be installed as specified in the erosion and sediment control plan. Stormwater flows must not be permitted into the grass channel until the bottom and side slopes are fully stabilized.

**Step 3.** Grade the grass channel to the final dimensions shown on the plan.

**Step 4.** Install check dams, driveway culverts and internal pre-treatment features as shown on the plan. Fill material used to construct check dams should be placed in 8- to 12-inch lifts and compacted to prevent settlement. The top of each check dam should be constructed level at the design elevation.

**Step 5 (Optional).** Till the bottom of the channel to a depth of 1 foot and incorporate compost amendments according to GIP-07 **Appendix A** of **GIP 07 – Downspout Disconnection**.

**Step 6.** Add soil amendments as needed, hydro-seed the bottom and banks of the grass channel, and peg in erosion control fabric or blanket where needed. After initial planting, a biodegradable erosion control fabric should be used, conforming to soil stabilization blanket and matting requirements found in MA-1 of the Tennessee Erosion and Sediment Control Handbook.

**Step 7.** Prepare planting holes for any trees and shrubs, then plant materials as shown in the landscaping plan and water them weekly in the first two months. The construction contract should include a Care and Replacement Warranty to ensure vegetation is properly established and survives during the first growing season following construction.

**Step 8.** Conduct the final construction inspection and develop a punch list for facility acceptance.

### 8.2 Construction Inspection

Inspections during construction are needed to ensure that the grass channel is built in accordance with these specifications. Some common pitfalls can be avoided by careful post-storm inspection of the grass channel:



- ❖ Make sure the desired coverage of turf or erosion control fabric has been achieved following construction, both on the channel beds and their contributing side-slopes.
- ❖ Inspect check dams and pre-treatment structures to make sure they are at correct elevations, are properly installed, and are working effectively.
- ❖ Make sure outfall protection/energy dissipation at concentrated inflows are stable.

The real test of a grass channel occurs after its first big storm. Minor adjustments are normally needed as part of this post-storm inspection (e.g., spot reseeding, gully repair, added armoring at inlets or realignment of outfalls and check dams).

## GIP – 08 SECTION 9: MAINTENANCE

### 9.1 Maintenance Document

Each BMP must have a Hamilton County Water Quality Stormwater Management Facility I&M Storm Water Management Facilities Agreement submitted for approval and maintained and updated by the BMP owner. The Stormwater Management Facilities I&M Agreement must be completed and submitted to the Program with the Land Disturbance permit application. The Stormwater Management Facilities I&M Agreement is for the use of the BMP owner in performing routine inspections. The developer/owner is responsible for the cost of maintenance and annual inspections. The BMP owner must maintain and update the BMP inspection and maintenance plan.

Maintenance requirements for grass channels include the following:

1. Maintain grass height of 3 to 4 inches.
2. Remove sediment build up in channel bottom when it accumulates to 25% of original total channel volume.
3. Ensure that rills and gullies have not formed on side slopes. Correct if necessary.
4. Remove trash and debris build up.
5. Replant areas where vegetation has not been successfully established.

All grass channels must be covered by a drainage easement to allow inspection and maintenance. If a grass channel is located in a residential private lot, the existence and purpose of the grass channel shall be noted on the deed of record.

### 9.2 Ongoing Maintenance

Once established, grass channels have minimal maintenance needs outside of the spring cleanup, regular mowing, repair of check dams and other measures to maintain the hydraulic efficiency of the channel and a dense, healthy grass cover.





**Table GIP-08-05 Suggested Spring Maintenance Inspections/Cleanups for Grass Channels<sup>1</sup>**

Activity
Add reinforcement planting to maintain 90% turf cover. Reseed any dead vegetation.
Remove any accumulated sand or sediment deposits behind check dams.
Inspect upstream and downstream of check dams for evidence of undercutting or erosion, and remove trash or blockages at weepholes.
Examine channel bottom for evidence of erosion, braiding, excessive ponding or dead grass.
Check inflow points for clogging and remove any sediment.
Inspect side slopes and grass filter strips for evidence of any rill or gully erosion and repair.
Look for any bare soil or sediment sources in the contributing drainage area and stabilize immediately.

<sup>1</sup> Source: VADCR (2011)

## GIP – 08 SECTION 10. AS-BUILT REQUIREMENTS

### 10.1 Grass Channel as Pretreatment

A number of structural controls such as bioretention areas and infiltration trenches may be supplemented by a grass channel that serves as pretreatment for runoff flowing to the device. The lengths of grass channels vary based on the drainage area imperviousness and slope. Channels must be no less than 20 feet long. **Table GIP -08-06** below gives the minimum lengths for grass channels based on slope and percent imperviousness.

Table GIP-08-06 Grass Channel Length Guidance <sup>1</sup>						
Parameter	<=33% Impervious		Between 34% and 66% Impervious		>=67% Impervious	
	< 2%	> 2%	< 2%	> 2%	< 2%	> 2%
Slope (max = 4%)						
Grass channel minimum length (feet) <sup>2</sup>	25	40	30	45	35	50

<sup>1</sup> Source: ARC (2001)

<sup>2</sup> Assumes 2-foot bottom width

After the grass channel has been constructed, an as-built certification of the grass channel must be prepared by a registered Professional Engineer and submitted to the Program. The as-built certification verifies that the BMP was installed as designed and approved.

The following components must be addressed in the as-built certification:

1. The channel must be adequately vegetated.
2. The water quality channel flow velocity must not exceed 1.0 foot per second.
3. A mechanism for overflow for large storm events must be provided.



## GIP – 08 SECTION 11: ROADWAY APPLICATION

Grass-lined channels have been widely used in roadway drainage systems for many years. They are easily constructed and maintained and work well in a variety of climates and soil conditions. Grass channels are applicable to:

- ❖ Major Thoroughfares (Interstates and Other Freeways)
- ❖ Major Urban Streets (Principal Arterials, Minor Arterials and Collectors)
- ❖ Local Roads

Grass channels within the right of way will only receive credit for treating water from within the right of way.



Figure GIP-08-05: Typical Grass Channel





Figure GIP-08-06: Roadside Channel in Spokane, WA (VADCR, 2011)

## GIP – 08 SECTION 12: REFERENCES

Atlanta Regional Commission (ARC). 2001. *Georgia Stormwater Management Manual*. Atlanta, GA.

Chesapeake Stormwater Network (CSN). 2008. *Technical Bulletin 1: Stormwater Design Guidelines for Karst Terrain in the Chesapeake Bay Watershed*. Version 1.0. Baltimore, MD. **Available online at:** <http://www.chesapeakestormwater.net/all-things-stormwater/stormwater-guidance-for-karst-terrain-in-the-chesapeake-bay.html>

City of Franklin, Stormwater Management Program. January 2014. *City of Franklin Stormwater Best Management Practices Manual*.

Claytor, R. and T. Schueler. 1996. *Design of Stormwater Filtering Systems*. Center for Watershed Protection. Ellicott City, MD.

CWP. 2007. *National Pollutant Removal Performance Database Version 3.0*. Center for Watershed Protection, Ellicott City, MD.

Haan, C.T., Barfield, B.J., and Hayes, J.C. *Design Hydrology and Sedimentology for Small Catchments*. Academic Press, New York, 1994.





Lantin, A., and M. Barrett. 2005. *Design and Pollutant Reduction of Vegetated Strips and Swales*. ASCE. Downloaded September, 2005.

Maryland Department of Environment (MDE). 2000. *Maryland Stormwater Design Manual*. Baltimore, MD.

Available online at:

[http://www.mde.state.md.us/Programs/WaterPrograms/SedimentandStormwater/stormwater design/index.asp](http://www.mde.state.md.us/Programs/WaterPrograms/SedimentandStormwater/stormwater%20design/index.asp)

Northern Virginia Regional Commission (NOVA). 2007. *Low Impact Development Supplement to the Northern Virginia BMP Handbook*. Fairfax, Virginia

Ree, W. 1949. *Hydraulic characteristics of vegetation for vegetated waterways*. Agricultural Engineering.

Schueler, T., D. Hirschman, M. Novotney and J. Zielinski. 2007. *Urban Stormwater Retrofit Practices*. Manual 3 in the Urban Subwatershed Restoration Manual Series. Center for Watershed Protection, Ellicott City, MD.

Schueler, T. 2008. Technical Support for the Baywide Runoff Reduction Method. Chesapeake Stormwater Network. Baltimore, MD. [www.chesapeakestormwater.net](http://www.chesapeakestormwater.net)

Storey, B.J., Li, M., McFalls, J.A., Yi, Y. 2009. *Stormwater Treatment with Vegetated Buffers*. Texas Transportation Institute. College Station, TX.

Temple, D.M., Robinson, K.M., Ahring, R.M., and Davis, A.G. 1987 "Stability design of grass-lined open channels." Agric. Handbook 667, Agric. Res. Service, U.S. Department of Agriculture, Washington, D.C.

Virginia Department of Conservation and Recreation (VADCR). 2011. Stormwater Design Specification No. 3: Grass Channel, Version 2.3, March 1, 2011. <http://vwrrc.vt.edu/swc/NonProprietaryBMPs.html>.

Virginia Department of Conservation and Recreation (VADCR). 1992. *Virginia Erosion and Sediment Control Handbook*

Virginia Department of Conservation and Recreation (VADCR). 1999. *Virginia Stormwater Management Handbook. Volumes 1 and 2*. Division of Soil and Water Conservation. Richmond, VA.

Wisconsin Department of Natural Resources. "Vegetated Infiltration Swale (1005)." *Interim Technical Standard, Conservation Practice Standards*. Standards Oversight Council, Madison, Wisconsin, 2004. Available online at: <http://dnr.wi.gov/org/water/wm/nps/pdf/stormwater/techstds/post/InterimInfiltrationSwale1005.pdf>



## Sheet Flow



GIP - 09

Hamilton County



Water Quality Program

**Description:** Impervious areas are disconnected and runoff is routed over a level spreader to sheet flow over adjacent vegetated areas. This slows runoff velocities, promotes infiltration, and allows sediment and attached pollutants to settle and/or be filtered by the vegetation.

**Variations:**

- 1) Disconnection to vegetated filter strips
- 2) Disconnection to conserved open space

**Components:**

- Level spreader – creates sheet flow
- Vegetated filter strip or open space with minimal slope

**Advantages/Benefits:**

- Cost effective
- Wildlife habitat potential
- High community acceptance

**Disadvantages/Limitations:**

- Small drainage area
- Sheet flow must be maintained to achieve design goals
- Often requires additional BMPs to achieve runoff reduction goals

**Design considerations:**

- Must have slopes between 2% and 6%
- Filter strips and conservation areas may be adjacent to and discharge to water quality buffers

**Selection Criteria:**

**50%-75% Runoff Reduction Credits**

See Table 9.1

**Land Use Considerations:**

- Residential
- Commercial
- Industrial (with approval)

**Maintenance:**

- Maintain dense, healthy vegetation to ensure sheet flow
- Inspect regularly for signs of erosion

**Maintenance Burden**  
 L = Low M = Moderate H = High



## GIP – 09 SECTION 1. DESCRIPTION

Filter strips are vegetated areas that treat sheet flow delivered from adjacent impervious areas by slowing runoff velocities and allowing sediment and attached pollutants to settle and/or be filtered by the vegetation. The two design variants of filter strips are (1) *Conserved Open Space* and (2) designed *Vegetated Filter Strips*. The design, installation, and management of these design variants are quite different, as outlined in this specification.

In both instances, stormwater must enter the filter strip or conserved open space as sheet flow. If the inflow is from a pipe or channel, an engineered level spreader must be designed in accordance with the criteria contained herein to convert the concentrated flow to sheet flow.

## GIP – 09 SECTION 2. PERFORMANCE

With proper design and maintenance, these practices can provide relatively high runoff reduction as shown in **Table GIP-09-01**.

Table GIP-09-01: Runoff Volume Reduction Provided by Filter Strips				
Stormwater Function	Conservation Area		Vegetated Filter Strip	
	HSG Soils A and B	HSG Soils C and D	HSG Soils A	HSG Soils B <sup>1</sup> , C and D
	Assume no CA <sup>2</sup> in Conservation Area		No CA <sup>3</sup>	With CA <sup>2</sup>
<b>Runoff Vol. Reduction (RR)</b>	75%	50%	50%	50%

<sup>1</sup> CSN (2008); CWP (2007)

<sup>2</sup> CA = Compost Amended Soils

<sup>3</sup> Compost amendments are generally not applicable for undisturbed A soils, although it may be advisable to incorporate them on mass-graded A or B soils and/or filter strips on B soils, in order to maintain runoff reduction rates.





## GIP – 09 SECTION 3. DESIGN TABLE

Conserved Open Space and Vegetated Filter Strips do not have two levels of design. Instead, each must meet the appropriate minimum criteria outlined in **Table GIP-09-02** and GIP-09 **Section 6** to qualify for the indicated level of runoff reduction. In addition, designers must conduct a site reconnaissance prior to design to confirm topography and soil conditions.

Table GIP-09-02. Filter Strip Design Criteria		
Design Issue	Conserved Open Space	Vegetated Filter Strip
Soil and Vegetative Cover (Sections 6.1 and 6.2)	Undisturbed soils and native vegetation	Amended soils and dense turf cover or landscaped with herbaceous cover, shrubs, and trees
Overall Slope and Width (perpendicular to the flow) (Section 5)	0.5% to 3% Slope – Minimum 35 ft. width 3% to 6% Slope – Minimum 50 ft. width The first 10 ft. of filter must be 2% or less in all cases <sup>2</sup>	1% <sup>1</sup> to 4% Slope – Minimum 35 ft. width 4% to 6% Slope – Minimum 50 ft. width The first 10 ft. of filter must be 2% or less in all cases
Sheet Flow (Section 5)	Maximum flow length of 150 ft. from adjacent pervious areas; Maximum flow length of 75 ft. from adjacent impervious areas	
Concentrated Flow (Section 6.3)	Length of ELS 6 Lip = 13 lin. ft. per each 1 cfs of inflow if area has 90% Cover <sup>3</sup> Length = 40 lin. ft. per 1 cfs for <sup>4</sup> forested or re-forested areas (ELS <sup>6</sup> length = 13 lin.ft. min; 130 lin.ft. max.)	Length of ELS <sup>6</sup> Lip = 13 lin.ft. per each 1 cfs of inflow (13 lin.ft. min; 130 lin.ft. max.)
Construction Stage (Section 7)	Located outside the limits of disturbance and protected by ESC controls	Prevent soil compaction by heavy equipment
Typical Applications	Adjacent to stream or wetland buffer or forest conservation area	Treat small areas of Impervious Cover (e.g., 5,000 sf) close to source
Compost Amendments (Section 6.1)	No	Yes (B, C, and D soils) <sup>5</sup>
Boundary Spreader (Section 6.3)	GD <sup>6</sup> at top of filter	GD <sup>6</sup> at top of filter PB <sup>6</sup> at toe of filter

<sup>1</sup> A minimum of 1 % is recommended to ensure positive drainage.

<sup>2</sup> For Conservation Areas with a varying slope, a pro-rated length may be computed only if the first 10 ft. is 2% or less.

<sup>3</sup> Vegetative Cover is described in GIP-09 **Section 6.2**.

<sup>4</sup> Where the Conserved Open Space is a mixture of native grasses, herbaceous cover and forest (or re-forested area), the length of the ELS <sup>6</sup> Lip can be established by computing a weighted average of the lengths required for each vegetation type. Refer to **Section 6.3** for design criteria

<sup>5</sup> The Program may waive the requirement for compost amended soils for filter strips on B soils under certain conditions (see GIP-09 **Section 6.1**).

<sup>6</sup> ELS = Engineered Level Spreader; GD = Gravel Diaphragm; PB = Permeable Berm.



**GIP – 09 SECTION 4. TYPICAL DETAILS**

Figure GIP-09-01 shows a typical approach for sheet flow to a Conserved Open Space (Cappiella *et al.*, 2006). Figures GIP-09-02 and 09-03 provide standard details for an engineered level spreader developed by North Carolina State University (Hathaway and Hunt, 2006).

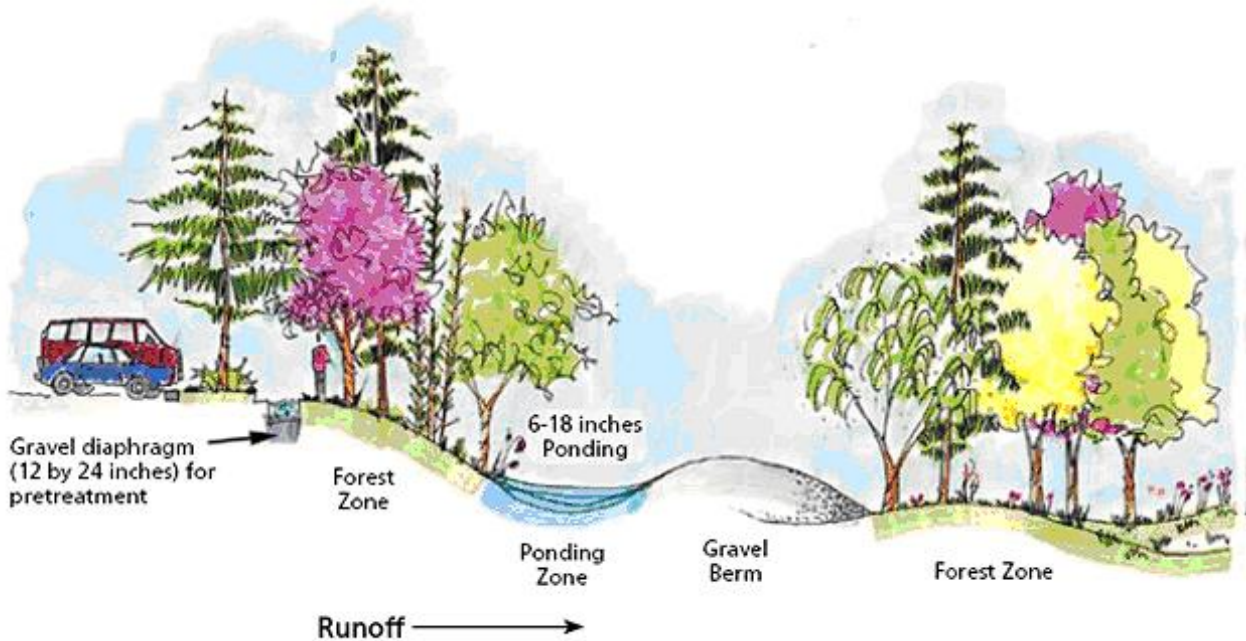


Figure GIP-09-01. Typical Sheet flow to Conserved Open Space (Hathaway and Hunt 2006)

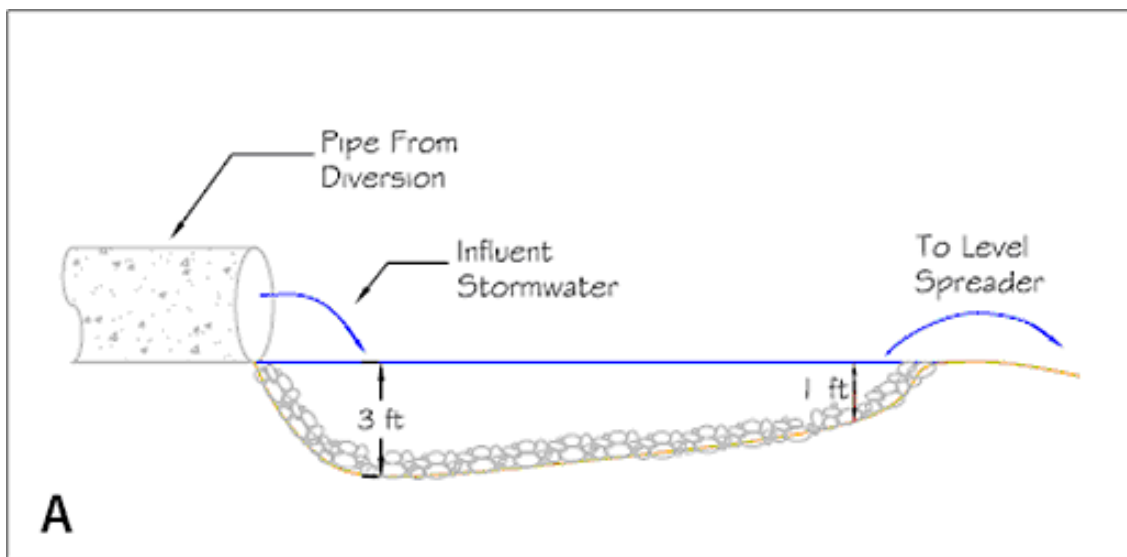


Figure GIP-09-02. Level Spreader Forebay (Hathaway and Hunt 2006)



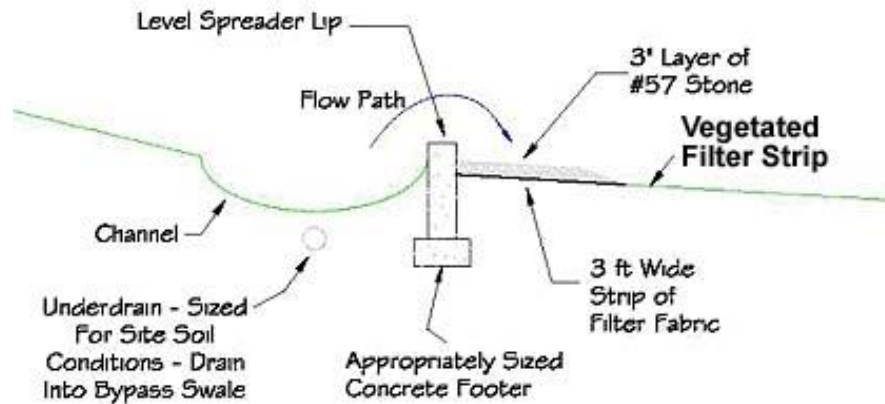
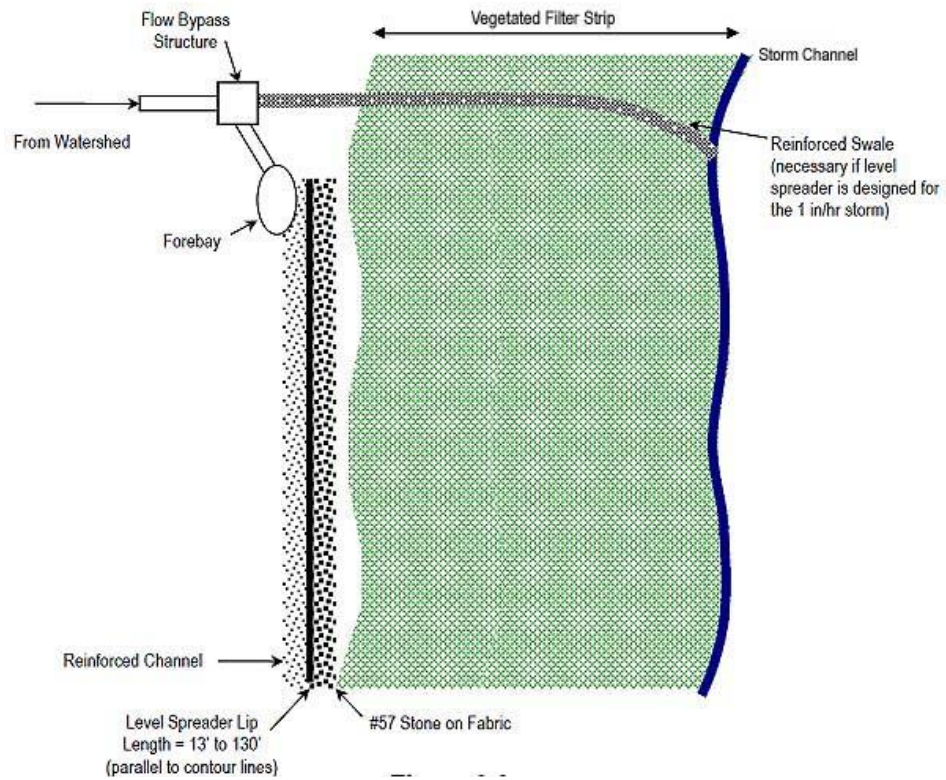


Figure GIP-09-03. Plan and Cross Section of Engineered Level Spreader (ELS)  
 (Hathaway 2006)



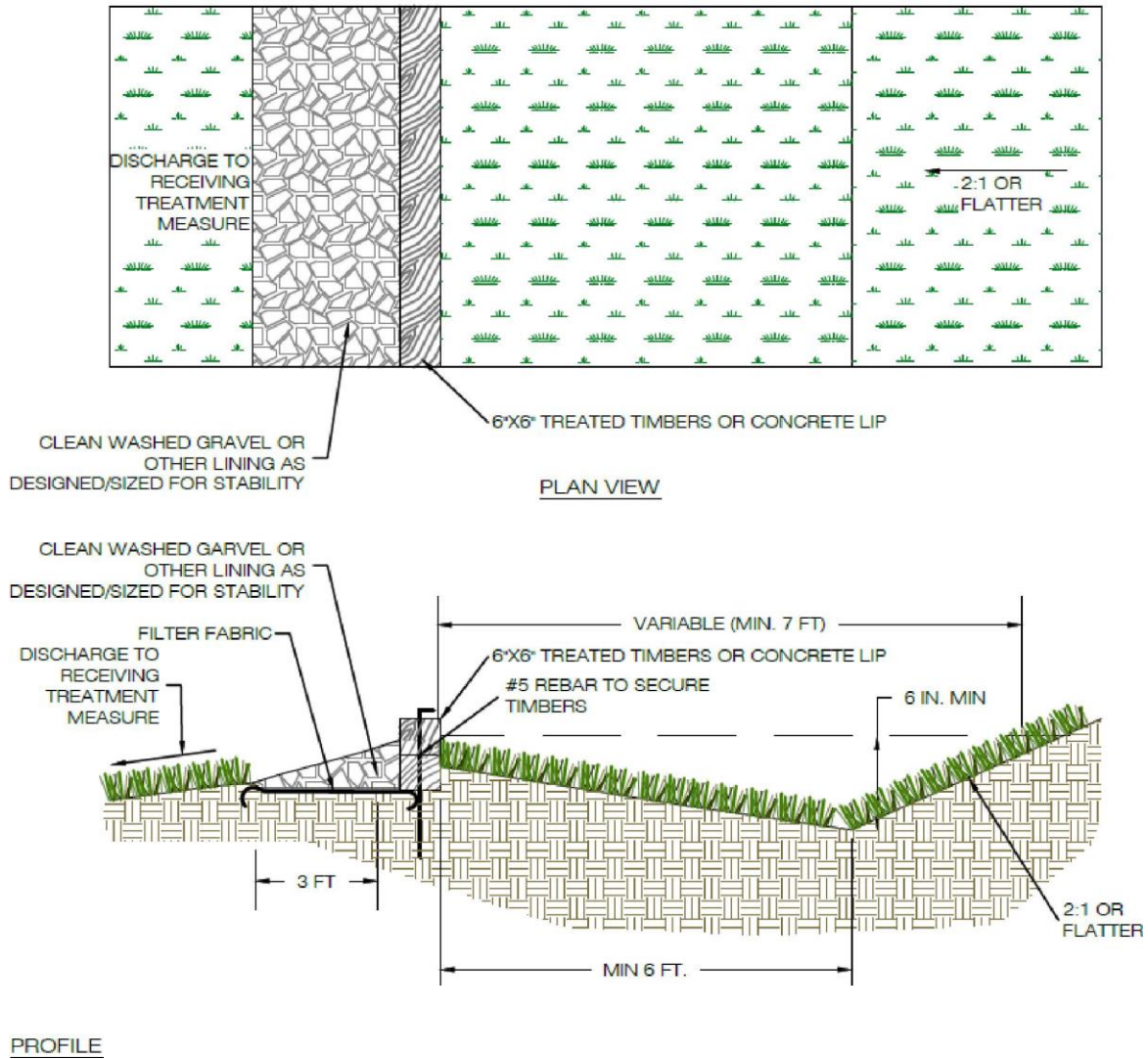


Figure GIP-09-04. Section - Level Spreader with Rigid Lip (source: VADCR, 2011)

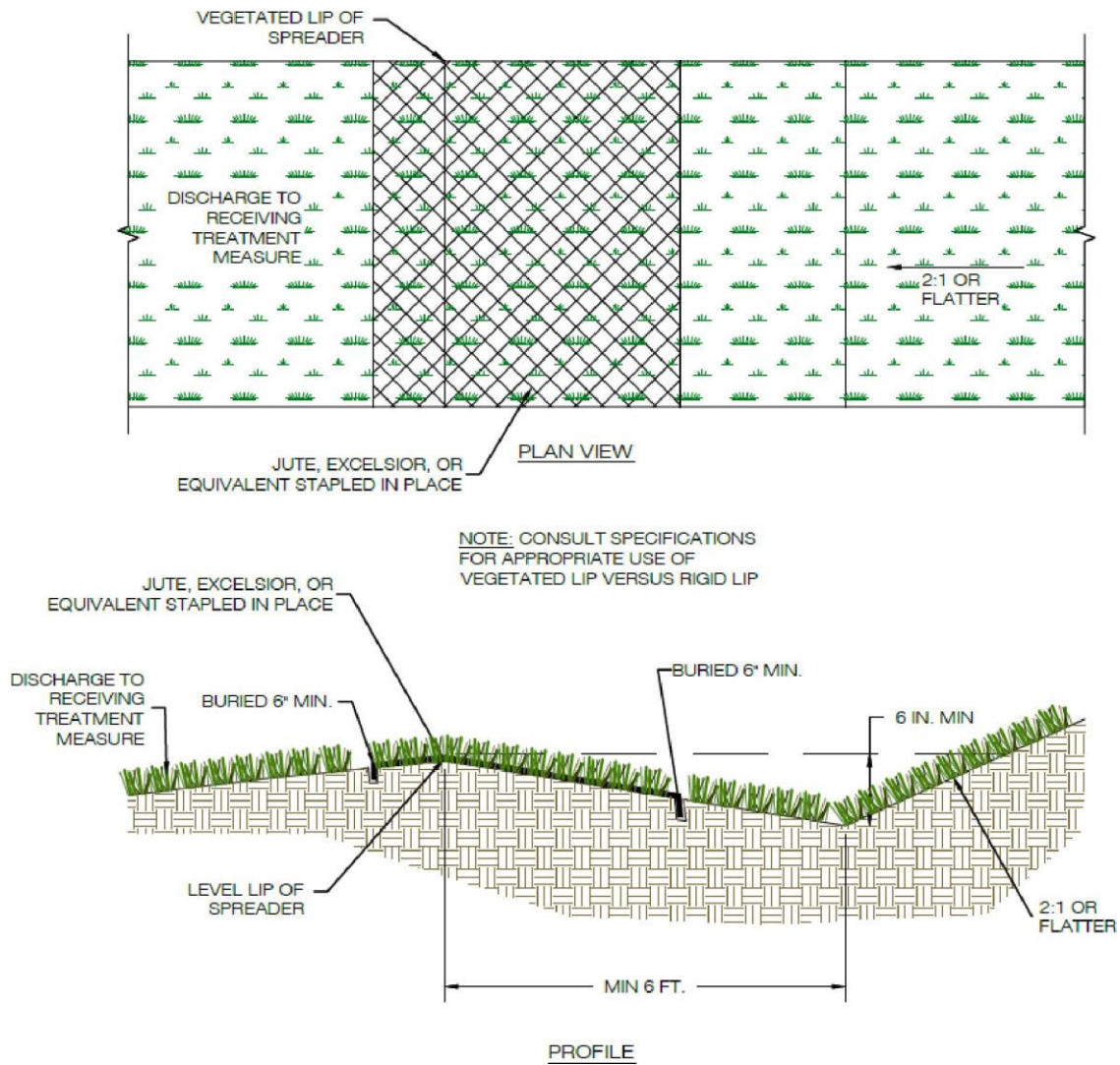


Figure GIP-09-05. Section - Alternative Level Spreader with Vegetated Lip (source: VADCR, 2011)



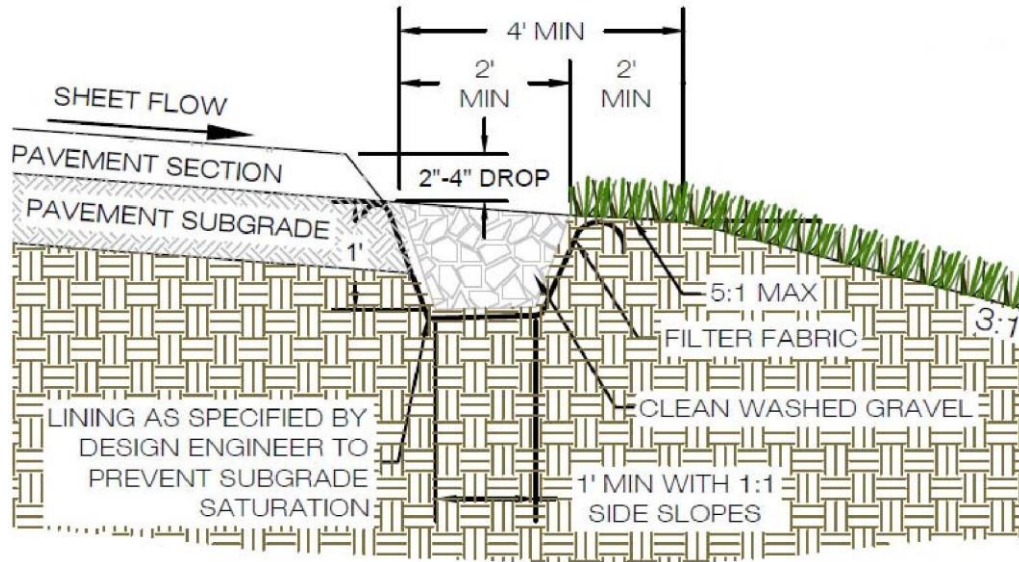


Figure GIP-09-06. Gravel Diaphragm – Sheet Flow Pre-treatment (source: VADCR, 2011)

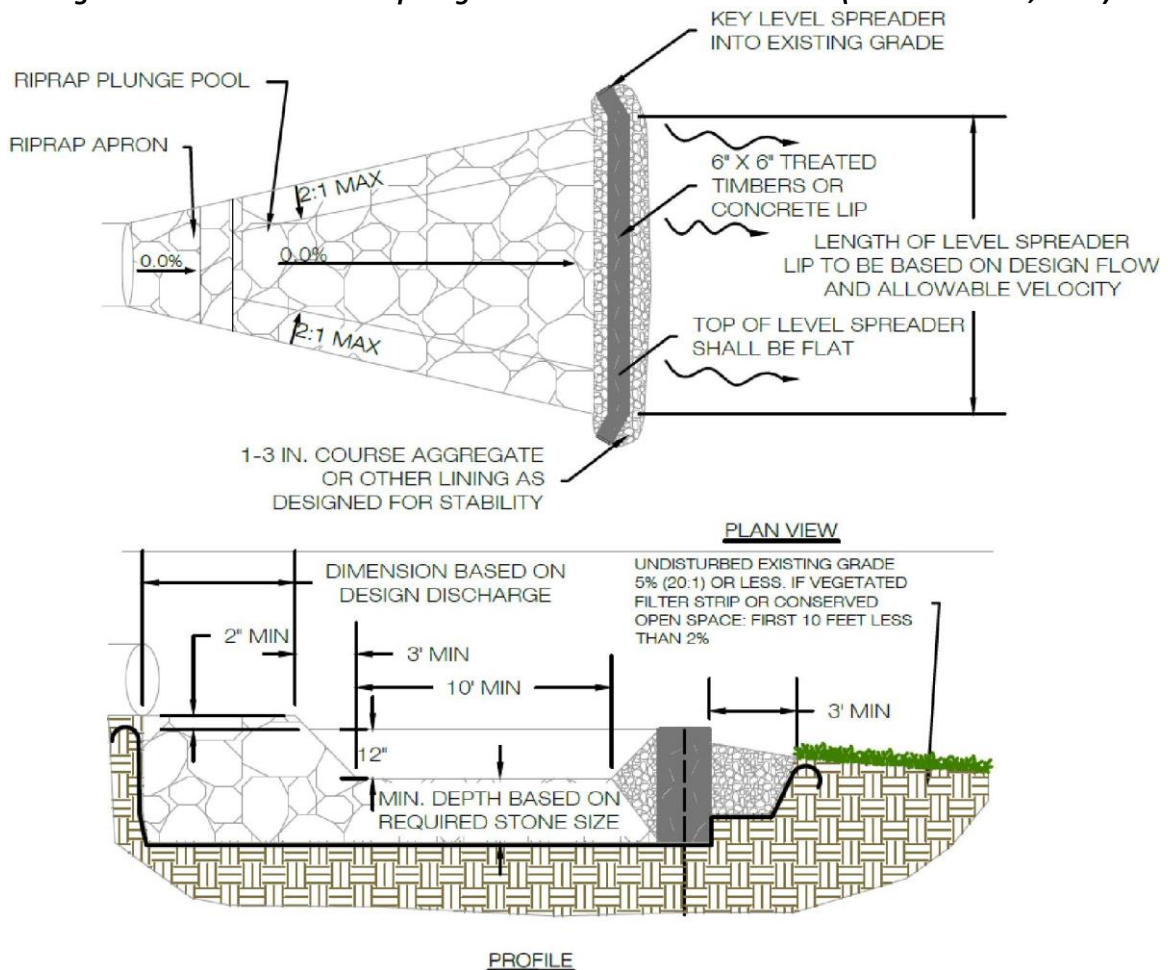


Figure GIP-09-07. Level Spreader: Pipe or Channel Flow to Filter Strip or Preserved Open Space (source: VADCR, 2011)



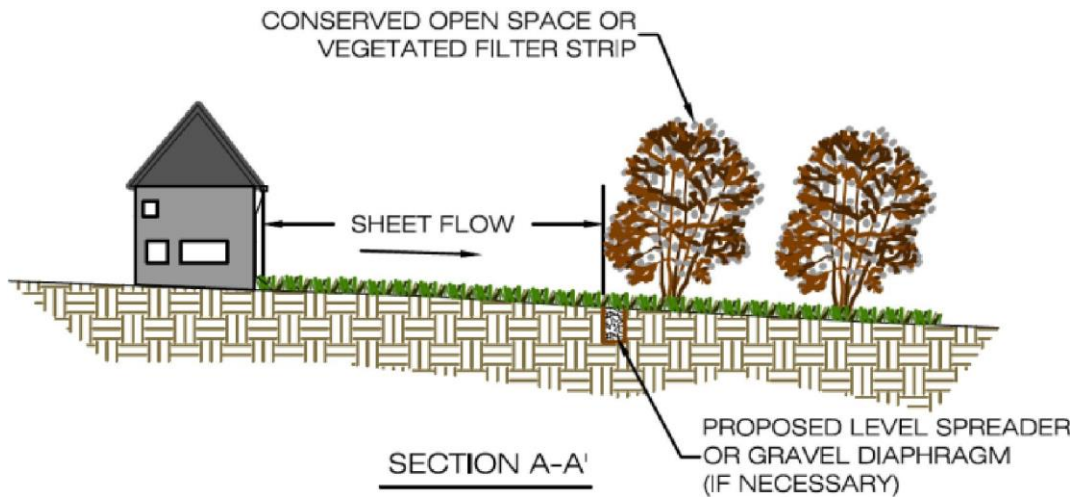
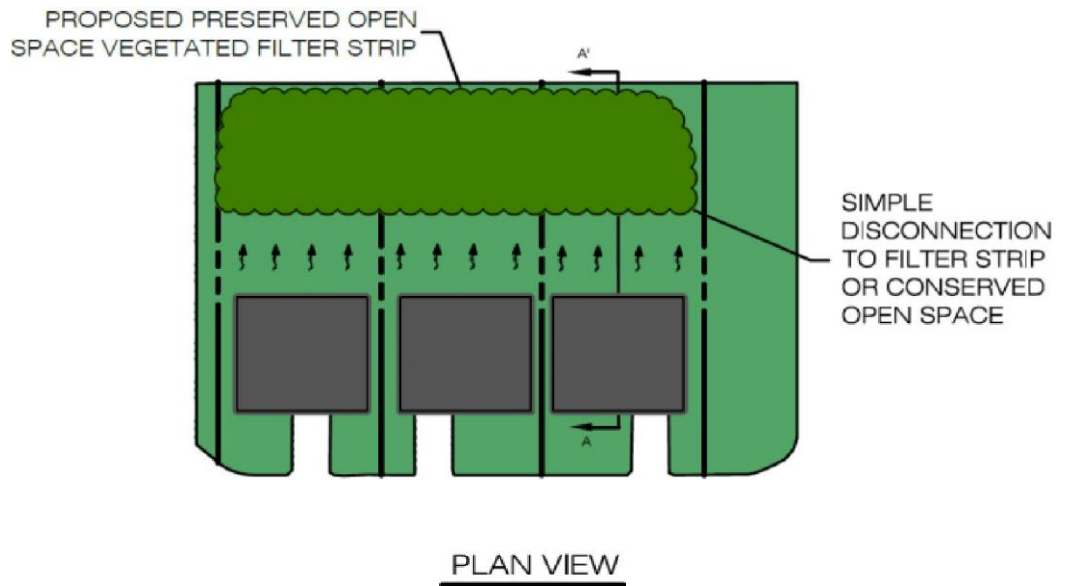


Figure GIP-09-08. Simple Disconnection to downstream Preserved Open Space or Vegetated Filter Strip (source: VADCR, 2011)



## GIP – 09 SECTION 5. PHYSICAL FEASIBILITY & DESIGN APPLICATIONS

### 5.1 Conserved Open Space

Designers may apply a runoff reduction credit to any impervious that is hydrologically connected and effectively treated by a protected Conserved Open Space that meets the following eligibility criteria:

- ❖ No major disturbance may occur within the conserved open space during or after construction (i.e., no clearing or grading is allowed except temporary disturbances associated with incidental utility construction, restoration operations, or management of nuisance vegetation). The Conserved Open Space area shall not be stripped of topsoil. Some light grading may be needed at the boundary using tracked vehicles to prevent compaction.
- ❖ The limits of disturbance should be clearly shown on all construction drawings and protected by acceptable signage and erosion control measures.
- ❖ A long term vegetation management plan must be prepared to maintain the Conserved Open Space in a natural vegetative condition. Generally, Conserved Open Space management plans do not allow any active management. However, a specific plan should be developed to manage the unintended consequences of passive recreation, control invasive species, provide for tree and understory maintenance, etc.
- ❖ The Conserved Open Space must be protected by a perpetual easement or deed restriction that assigns the responsible party to ensure that no future development, disturbance, or clearing may occur within the area.
- ❖ The practice does *not* apply to jurisdictional wetlands that are sensitive to increased inputs of stormwater runoff.

### 5.2 Vegetated Filter Strips

Vegetated Filter Strips are best suited to treat runoff from small segments of impervious cover (usually less than 5,000 sq. ft.) adjacent to road shoulders, small parking lots and rooftops. Vegetated Filter Strips may also be used as pretreatment for another stormwater practice such as a dry swale, bioretention, or infiltration areas. If sufficient pervious area is available at the site, larger areas of impervious cover can be treated by vegetated filter strips, using an engineered level spreader to recreate sheet flow.

Conserved Open Space and Vegetated Filter Strips can be used in a variety of situations; however there are several constraints to their use:

- ❖ **Filter Slopes and Widths.** Maximum slope for both Conserved Open Space and Vegetated Filter Strips is 6%, in order to maintain sheet flow through the practice. In addition, the overall contributing drainage area must likewise be relatively flat to ensure sheet flow draining into the filter. Where this is not possible, alternative measures, such as an engineered level spreader, can be used. Minimum widths (flow path) for Conserved Open Space and Vegetated Filter Strips are dependent on slope, as specified in **Table 9.2**.
- ❖ **Soils.** Vegetated Filter Strips are appropriate for all soil types, except fill soils. The runoff reduction rate, however, is dependent on the underlying Hydrologic Soil Groups (see **Table 9.1**) and whether soils receive compost amendments.
- ❖ **Contributing Flow Path to Filter.** Vegetated Filter Strips are used to treat very small drainage areas of a few acres or less. The limiting design factor is the length of flow directed to the filter. As a rule, flow tends to concentrate after 75 feet of flow length for impervious surfaces, and 150 feet for pervious surfaces (Claytor, 1996). When flow concentrates, it moves too rapidly to be effectively treated by a Vegetated Filter Strip, unless an engineered level spreader is used. When the existing flow at a site is concentrated, a



grass channel or a water quality swale should be used instead of a Vegetated Filter Strip (Lantin and Barrett, 2005).

- ❖ **Hotspot Land Uses.** Vegetated Filter Strips should not receive hotspot runoff, since the infiltrated runoff could cause groundwater contamination.
- ❖ **Proximity of Underground Utilities.** Underground pipes and conduits that cross the Vegetated Filter Strip are acceptable.

## GIP – 09 SECTION 6. DESIGN CRITERIA

### 6.1 Compost Soil Amendments

Compost soil amendments will enhance the runoff reduction capability of a vegetated filter strip when located on hydrologic soil groups B, C, and D, subject to the following design requirements:

- ❖ The compost amendments should extend over the full length and width of the filter strip.
- ❖ The amount of approved compost material and the depth to which it must be incorporated is outlined in GIP-09 Appendix A.
- ❖ The amended area will be raked to achieve the most level slope possible without using heavy construction equipment, and it will be stabilized rapidly with perennial grass and/or herbaceous species.
- ❖ If slopes exceed 3%, a protective biodegradable fabric or matting should be installed to stabilize the site prior to runoff discharge.
- ❖ Compost amendments should not be incorporated until the gravel diaphragm and/or engineered level spreader are installed (see Section 6.3).
- ❖ The City may waive the requirement for compost amendments on HSG-B soils in order to receive credit as a filter strip if (1) the designer can provide verification of the adequacy of the on-site soil type, texture, and profile to function as a filter strip, and (2) the area designated for the filter strip will not be disturbed during construction.

### 6.2 Planting and Vegetation Management

**Conserved Open Space .** No grading or clearing of native vegetation is allowed within the Conserved Open Space.

**Reforested Conserved Open Space.** At some sites, the Conserved Open Space may be in turf or meadow cover, or overrun with invasive plants and vines. In these situations, a landscape architect should prepare a reforestation plan for the Conserved Open Space utilizing the reforestation specifications as described under **GIP-10, Reforestation**, with any credits and associated plans receiving approval by the Program.

**Vegetated Filter Strips.** Vegetated Filter Strips should be planted at such a density to achieve a 90% grass/herbaceous cover after the second growing season. Performance has been shown to fall rapidly as vegetative cover falls below 80%. Filter strips should be seeded, not sodded, whenever possible. Seeding establishes deeper roots, and sod may have muck soil that is not conducive to infiltration (Storey et. al., 2009). The filter strip vegetation may consist of turf grasses, meadow grasses, other herbaceous plants, shrubs, and trees, as long as the primary goal of at least 90% coverage with grasses and/or other herbaceous plants is achieved. Designers should choose vegetation that stabilizes the soil and is salt tolerant. Vegetation at the toe of the filter, where temporary ponding may occur behind the permeable berm, should be able to withstand both wet and dry periods. The planting areas can be divided into zones to account for differences in inundation and slope.





### 6.3 Diaphragms, Berms and Level Spreaders

**Gravel Diaphragms:** A pea gravel diaphragm at the top of the slope is required for both Conserved Open Space and Vegetated Filter Strips that receive sheetflow. The pea gravel diaphragm is created by excavating a 2-foot wide and 1-foot deep trench that runs on the same contour at the top of the filter strip. The diaphragm serves two purposes. First, it acts as a pretreatment device, settling out sediment particles before they reach the practice. Second, it acts as a level spreader, maintaining sheet flow as runoff flows over the Filter Strip. Refer to **Figure GIP-09-06**.

- ❖ The flow should travel over the impervious area and to the practice as sheet flow and then drop at least 3 inches onto the gravel diaphragm. The drop helps to prevent runoff from running laterally along the pavement edge, where grit and debris tend to build up (thus allowing by-pass of the Filter Strip).
- ❖ A layer of filter fabric should be placed between the gravel and the underlying soil trench.
- ❖ If the contributing drainage area is steep (6% slope or greater), then larger stone (clean bank-run gravel that meets TDOT #57 grade) should be used in the diaphragm.
- ❖ **Permeable Berm:** Vegetated Filter Strips should be designed with a permeable berm at the toe of the Filter Strip to create a shallow ponding area. Runoff ponds behind the berm and gradually flows through outlet pipes in the berm or through a gravel lens in the berm with a perforated pipe. During larger storms, runoff may overtop the berm (Cappiella *et al.*, 2006). The permeable berm should have the following properties:
  - ❖ A wide and shallow trench, 6 to 12 inches deep, should be excavated at the upstream toe of the berm, parallel with the contours.
  - ❖ Media for the berm should consist of 40% excavated soil, 40% sand, and 20% pea gravel.
  - ❖ The berm 6 to 12 inches high should be located down gradient of the excavated depression and should have gentle side slopes to promote easy mowing (Cappiella *et al.*, 2006).
  - ❖ Stone may be needed to armor the top of berm to handle extreme storm events.
  - ❖ A permeable berm is not needed when vegetated filter strips are used as pretreatment to another stormwater practice.

**Engineered Level Spreaders.** The design of engineered level spreaders should conform to the following design criteria based on recommendations of Hathaway and Hunt (2006) in order to ensure non-erosive sheet flow into the vegetated area. **Figure 9.3** represents a configuration that includes a bypass structure that diverts the design storm to the level spreader, and bypasses the larger storm events around the Conserved Open Space or Vegetated Filter Strip through an improved channel.

An alternative approach involves pipe or channels discharging at the landward edge of a floodplain. The entire flow is directed through a stilling basin energy dissipater and then a level spreader such that the entire design storm for the conveyance system (typically a 10-year frequency storm) is discharged as sheet flow through the floodplain.

Key design elements of the engineered level spreader, as provided in **Figures 9.2 and 9.3**, include the following:

- ❖ High Flow Bypass provides safe passage for larger design storms through the filter strip. The bypass channel should accommodate all peak flows greater than the water quality design flow.
- ❖ A Forebay should have a maximum depth of 3 feet and gradually transition to a depth of 1 foot at the level spreader lip (**Figure GIP-09-02**). The forebay is sized such that the surface area is 0.2% of the contributing



impervious area. (A forebay is not necessary if the concentrated flow is from the outlet of an extended detention basin or similar practice).

- ❖ The length of the level spreader should be determined by the type of filter area and the design flow:
  - o 13 feet of level spreader length per every 1 cubic foot per second (cfs) of inflow for discharges to a Vegetated Filter Strip or Conserved Open Space consisting of native grasses or thick ground cover;
  - o 40 feet of level spreader length per every 1 cfs of inflow when the spreader discharges to a Conserved Open Space consisting of forested or reforested area (Hathaway and Hunt, 2006).
  - o Where the Conserved Open Space is a mix of grass and forest (or re-forested), establish the level spreader length by computing a weighted average of the lengths required for each vegetation type.
  - o The minimum level spreader length is 13 feet and the maximum is 130 feet.
  - o For the purposes of determining the Level Spreader length, the peak discharge shall be determined using the Rational Equation with an intensity of 1-inch/hour.
- ❖ The level spreader lip should be concrete, wood or pre-fabricated metal, with a well-anchored footer, or other accepted rigid, non-erodible material.
- ❖ The ends of the level spreader section should be tied back into the slope to avoid scouring around the ends of the level spreader; otherwise, short-circuiting of the facility could create erosion.
- ❖ The width of the level spreader channel on the up-stream side of the level lip should be three times the diameter of the inflow pipe, and the depth should be 9 inches or one-half the culvert diameter, whichever is greater.
- ❖ The level spreader should be placed 3 to 6 inches above the downstream natural grade elevation to avoid turf buildup. In order to prevent grade drops that re-concentrate the flows, a 3-foot long section of course aggregate, underlain by filter fabric, should be installed just below the spreader to transition from the level spreader to natural grade.

Vegetated receiving areas down-gradient from the level spreader must be able to withstand the force of the flow coming over the lip of the device. It may be necessary to stabilize this area with temporary or permanent materials in accordance with the calculated velocity (on-line system peak, or diverted off-line peak) and material specifications, along with seeding and stabilization in conformance with the Tennessee Erosion and Sediment Control Handbook.



## 6.4 Filter Design Material Specifications

Table GIP-09-03 describes materials specifications for the primary treatment within filter strips.

Table GIP-09-03. Vegetated Filter Strip Materials Specifications		
Material	Specification	Quantity
Gravel Diaphragm	Pea Gravel (#8 or ASTM equivalent) or where steep (6% +) use clean bank-run TDOT #57 or ASTM equivalent (1-inch maximum).	Diaphragm should be 2 feet wide, 1 foot deep, and at least 3 inches below the edge of pavement.
Permeable Berm	40% excavated soil, 40% sand, and 20% pea gravel to serve as the media for the berm.	
Geotextile	Needed, non-woven, polypropylene geotextile meeting the following specifications: Grab Tensile Strength (ASTM D4632): > 120 lbs. Mullen Burst Strength (ASTM D3786): > 225 lbs./sq. in. Flow Rate (ASTM D4491): > 125 gpm/sq. ft. Apparent Opening Size (ASTM D4751): US #70 or #80 sieve	
Engineered Level Spreader	Level Spreader lip should be concrete, metal, timber, or other rigid material; Reinforced channel on upstream of lip. See Hathaway and Hunt (2006)	
Erosion Control Fabric or Matting	Where flow velocities dictate, use woven biodegradable erosion control fabric or mats that are durable enough to last at least 2 growing seasons.	
Topsoil	If existing topsoil is inadequate to support dense turf growth, imported top soil (loamy sand or sandy loam texture), with less than 5% clay content, corrected pH at 6 to 7, a soluble salt content not exceeding 500 ppm, and an organic matter content of at least 2% shall be used. Topsoil shall be uniformly distributed and lightly compacted to a minimum depth of 6 to 8 inches	
Compost	Compost shall be derived from plant material and provided by a member of the U.S. Composting Seal of Testing Assurance (STA) program, as outlined in GIP-09 Appendix A.	

## GIP – 09 SECTION 7: CONSTRUCTION

### 7.1 Construction Sequence for Conserved Open Space Areas

The Conserved Open Space must be fully protected during the construction stage of development and kept outside the limits of disturbance on the Erosion Prevention and Sediment Control (EPSC) Plan.

- ❖ No clearing, grading or heavy equipment access is allowed except temporary disturbances associated with incidental utility construction, restoration operations or management of nuisance vegetation.
- ❖ The perimeter of the Conserved Open Space shall be protected by a silt fence, chain link fence, orange safety fence, or other measures in order to meet stormwater pollution prevention sediment discharge requirements.
- ❖ The limits of disturbance should be clearly shown on site development plans, Grading Permit applications and/or concept plans and identified and shall be clearly marked in the field.





- ❖ Construction of the gravel diaphragm or engineered level spreader shall not commence until the contributing drainage area has been stabilized and perimeter EPSC has been removed and cleaned out.
- ❖ Some light grading may be needed at the Filter Strip boundary; this should be done with tracked vehicles to prevent compaction.
- ❖ Stormwater should not be diverted into the Vegetated Filter Strip until the gravel diaphragm and/or level spreader are installed and stabilized.

### 7.2 Construction Sequence for Vegetated Filter Strips

Vegetated Filter Strips can be within the limits of disturbance during construction. The following procedures should be followed during construction:

- ❖ Before site work begins, Vegetated Filter Strip boundaries should be clearly marked.
- ❖ Only vehicular traffic used for Filter Strip construction should be allowed within 10 feet of the Filter Strip boundary (City of Portland, 2004).
- ❖ If existing topsoil is stripped during grading, it shall be stockpiled for later use.
- ❖ Construction runoff should be directed away from the proposed Filter Strip site, using perimeter silt fence, or, preferably, a diversion dike.
- ❖ Construction of the gravel diaphragm or engineered level spreader shall not commence until the contributing drainage area has been stabilized and perimeter EPSC has been removed and cleaned out.
- ❖ Vegetated Filter Strips require light grading to achieve desired elevations and slopes. This should be done with tracked vehicles to prevent compaction. Topsoil and or compost amendments should be incorporated evenly across the filter strip area, stabilized with seed, and protected by biodegradable erosion control matting or blankets.
- ❖ Stormwater should not be diverted into the Filter Strip until the turf cover is dense and well established.

### 7.3 Construction Inspection

Construction inspection is critical to obtain adequate spot elevations, to ensure the gravel diaphragm or Engineered Level Spreader (ELS) is completely level, on the same contour and constructed to the correct design elevation. As-built certification is required to ensure compliance with design standards. Inspectors should evaluate the performance of the Filter Strip after the first big storm to look for evidence of gullies, outflanking, undercutting or sparse vegetative cover. Spot repairs should be made, as needed.

## GIP – 09 SECTION 8. AS-BUILT REQUIREMENTS

After the filter strip has been constructed, the developer must have an as-built certification of the filter strip conducted by a registered Professional Engineer. The as-built certification verifies that the BMP was installed as designed and approved. The following components must be addressed in the as-built certification:

1. Ensure level spreader is properly installed to create sheet flow.
2. Ensure vegetated filter strip or open space that receives sheet flow has minimal slope.
3. Ensure paved area drains towards pervious area.
4. Ensure the proper vegetation has been established or protected.
5. If using amended soils ensure proper installation by digging a test pit to verify the depth of mulch, amended soil and scarification.



## GIP – 09 SECTION 9. MAINTENANCE

### 9.1 Maintenance Document

Each BMP must have a Hamilton County Water Quality Stormwater Management Facility I&M Storm Water Management Facilities Agreement submitted for approval and maintained and updated by the BMP owner. The Stormwater Management Facilities I&M Agreement must be completed and submitted to the Program with the Land Disturbance permit application. The Stormwater Management Facilities I&M Agreement is for the use of the BMP owner in performing routine inspections. The developer/owner is responsible for the cost of maintenance and annual inspections. The BMP owner must maintain and update the BMP inspections and maintenance plan.

The Sheet Flow GIP must be covered by a drainage easement to allow inspection and maintenance and be included in the site's Maintenance Document. If the filter area is a natural Conserved Open Space, it must be protected by a perpetual easement or deed restriction that assigns the responsible party to ensure that no future development, disturbance or clearing may occur within the area, except as stipulated in the vegetation maintenance plan.

### 9.2 Maintenance Inspections

Annual inspections are used to trigger maintenance operations such as sediment removal, spot re-vegetation and level spreader repair. Ideally, inspections should be conducted in the non-growing season when it is easier to see the flow path.

Inspectors should check to ensure that:

- ❖ Flows through the Filter Strip do not short-circuit the overflow control section;
- ❖ Debris and sediment does not build up at the top of the Filter Strip;
- ❖ Foot or vehicular traffic does not compromise the gravel diaphragm;
- ❖ Scour and erosion do not occur within the Filter Strip;
- ❖ Sediments are cleaned out of Level Spreader forebays and flow splitters; and
- ❖ Vegetative density exceeds a 90% cover in the boundary zone or grass filter.

### 9.3 Ongoing Maintenance

Once established, Vegetated Filter Strips have minimal maintenance needs outside of the spring clean-up, regular mowing, repair of check dams and other measures to maintain the hydraulic efficiency of the strip and a dense, healthy grass cover. Vegetated Filter Strips that consist of grass/turf cover should be mowed at least twice a year to prevent woody growth.



**Filter strip surrounding bioretention cell  
Fort Bragg, NC.  
(Source: N.Weinstein, LIDC)**



## GIP – 09 SECTION 11. REFERENCES

Cappiella, K., T. Schueler, and T. Wright. 2006. *Urban Watershed Forestry Manual, Part 2. Conserving and Planting Trees at Development Sites*. Center for Watershed Protection. Prepared for United States Department of Agriculture, Forest Service.

Chesapeake Stormwater Network (CSN). 2008. *Technical Bulletin 1: Stormwater Design Guidelines for Karst Terrain in the Chesapeake Bay Watershed*. Version 1.0. Baltimore, MD. Available online at: <http://www.chesapeakestormwater.net/all-things-stormwater/stormwater-guidance-for-karst-terrain-in-the-chesapeake-bay.html>

City of Franklin, Stormwater Management Program. January 2014. *City of Franklin Stormwater Best Management Practices Manual*.

City of Portland, Environmental Services. 2004. *Portland Stormwater Management Manual*. Portland, OR. Available online at: <http://www.portlandonline.com/bes/index.cfm?c=dfbbh>

Claytor, R. and T. Schueler. 1996. *Design of Stormwater Filtering Systems*. Center for Watershed Protection. Ellicott City, MD.

CWP. 2007. *National Pollutant Removal Performance Database Version 3.0*. Center for Watershed Protection, Ellicott City, MD.

Hathaway, J. and B. Hunt. 2006. *Level Spreaders: Overview, Design, and Maintenance*. Department of Biological and Agricultural Engineering. NC State University. Raleigh, NC. <http://www.bae.ncsu.edu/stormwater/PublicationFiles/LevelSpreaders2006.pdf>.

Henrico County, Virginia. *Henrico County Environmental Program Manual*. Available online at: <http://www.co.henrico.va.us/works/eesd/>

Lantin, A. and M. Barrett. 2005. Design and Pollutant Reduction of Vegetated Strips and Swales. In: World Water Congress 2005, May 15, 2005, Anchorage, Alaska.

North Carolina State University. *Level Spreader Design Worksheet*. Available online at: <http://www.bae.ncsu.edu/conted/main/handouts/lsworksheet.pdf>

North Carolina Department of Environment and Natural Resources, Division of Water Quality. "Level Spreader Design Guidelines." January 2007. Available online at: <http://h2o.enr.state.nc.us/su/ManualsFactsheets.htm>

Northern Virginia Regional Commission. 2007. *Low Impact Development Supplement to the Northern Virginia BMP Handbook*. Fairfax, Virginia.

*Philadelphia Stormwater Management Guidance Manual*. Available online at: <http://www.phillyriverinfo.org/Programs/SubprogramMain.aspx?Id=StormwaterManual>





Schueler, T., D. Hirschman, M. Novotny and J. Zielinski. 2007. *Urban Stormwater Retrofit Practices*. Manual 3 in the Urban Subwatershed Restoration Manual Series. Center for Watershed Protection, Ellicott City, MD.

Schueler, T. 2008. Technical Support for the Baywide Runoff Reduction Method. Chesapeake Stormwater Network. Baltimore, MD. [www.chesapeakestormwater.net](http://www.chesapeakestormwater.net)

Storey, B.J., Li, M., McFalls, J.A., Yi, Y. 2009. *Stormwater Treatment with Vegetated Buffers*. Texas Transportation Institute. College Station, TX.

Virginia Department of Conservation and Recreation (VADCR). 1999. *Virginia Stormwater Management Handbook. Volumes 1 and 2*. Division of Soil and Water Conservation. Richmond, VA.

Virginia Department of Conservation and Recreation (VADCR). 2011. Stormwater Design Specification No. 2: Sheet Flow To a Vegetated Filter Strip or Conserved Open Space, version 1.9, March 1, 2011.



## GIP – 09 APPENDIX A DESIGN CRITERIA FOR AMENDING SOILS WITH COMPOST

### SECTION 1: DESCRIPTION

Soil restoration is a practice applied after construction, to deeply till compacted soils and restore their porosity by amending them with compost. These soil amendments can reduce the generation of runoff from compacted urban lawns and may also be used to enhance the runoff reduction performance of downspout disconnections, grass channels, and filter strips.

### SECTION 2: PHYSICAL FEASIBILITY & DESIGN APPLICATIONS

Compost amended soils are suitable for any pervious area where soils have been or will be compacted by the grading and construction process. They are particularly well suited when existing soils have low infiltration rates (HSG C and D) and when the pervious area will be used to filter runoff (downspout disconnections and grass channels). The area or strip of amended soils should be hydraulically connected to the stormwater conveyance system. Soil restoration is recommended for sites that will experience mass grading of more than a foot of cut and fill across the site.

Compost amendments are not recommended where:

- ❖ Existing soils have high infiltration rates (e.g., HSG A and B); although compost amendments may be needed at mass-graded B soils in order to maintain runoff reduction rates.
- ❖ The water table or bedrock is located within 1.5 feet of the soil surface.
- ❖ Slopes exceed 10%.
- ❖ Existing soils are saturated or seasonally wet.
- ❖ They would harm roots of existing trees (keep amendments outside the tree drip line).
- ❖ The downhill slope runs toward an existing or proposed building foundation.
- ❖ The contributing impervious surface area exceeds the surface area of the amended soils.

Compost amendments can be applied to the entire pervious area of a development or be applied only to select areas of the site to enhance the performance of runoff reduction practices. Some common design applications include:

- ❖ Reduce runoff from compacted lawns.
- ❖ Enhance rooftop disconnections on poor soils.
- ❖ Increase runoff reduction within a grass channel.
- ❖ Increase runoff reduction within a vegetated filter strip.
- ❖ Increase the runoff reduction function of a tree cluster or reforested area of the site.

### SECTION 3: DESIGN CRITERIA

#### 3.1 Soil Testing

Soil tests are required during two stages of the compost amendment process. The first testing is done to ascertain pre-construction soil properties at proposed amendment areas. The initial testing is used to determine soil properties to a depth 1 foot below the proposed amendment area, with respect to bulk density, pH, salts, and soil nutrients. These tests should be conducted every 5,000 square feet, and are used to characterize potential drainage problems and determine what, if any, further soil amendments are needed.



The second soil test is taken at least one week after the compost has been incorporated into the soils. This soil analysis should be conducted by a reputable laboratory to determine whether any further nutritional requirements, pH adjustment, and organic matter adjustments are necessary for plant growth. This soil analysis should be done in conjunction with the final construction inspection to ensure tilling or subsoiling has achieved design depths.

### 3.2 Determining Depth of Compost Incorporation

The depth of compost amendment is based on the relationship of the surface area of the soil amendment to the contributing area of impervious cover that it receives. **Table 9-A.1** presents some general guidance derived from soil modeling by Holman-Dodds (2004) that evaluates the required depth to which compost must be incorporated. Some adjustments to the recommended incorporation depth were made to reflect alternative recommendations of Roa Espinosa (2006), Balousek (2003), Chollak and Rosenfeld (1998) and others.

Table 9-A.1. Short-Cut Method to Determine Compost and Incorporation Depths				
	Contributing Impervious Cover to Soil Amendment Area Ratio			
	IC/SA = 0.2	IC/SA = 0.5	IC/SA = 0.75	IC/SA = 1.0 <sup>3</sup>
Compost (in) <sup>4</sup>	2 to 4 <sup>5</sup>	3 to 6 <sup>5</sup>	4 to 8 <sup>5</sup>	6 to 10 <sup>5</sup>
Incorporation Depth (in)	6 to 10 <sup>5</sup>	8 to 12 <sup>5</sup>	15 to 18 <sup>5</sup>	18 to 24 <sup>5</sup>
Incorporation Method	Rototiller	Tiller	Subsoiler	Subsoiler

<sup>1</sup> IC = contrib. impervious cover (sq. ft.) and SA = surface area of compost amendment (sq. ft.)

<sup>2</sup> For amendment of compacted lawns that do not receive off-site runoff

<sup>3</sup> In general, IC/SA ratios greater than 1 should be avoided

<sup>4</sup> Average depth of compost added

<sup>5</sup> Lower end for B soils, higher end for C/D soils

Once the area and depth of the compost amendments are known, the designer can estimate the total amount of compost needed using the following estimator:

#### Equation GIP-09-01. Compost Quantity Estimation

$$C = A * D * 0.0031$$

Where:

- C = compost needed (cu. yds.)
- A = area of soil amended (sq. ft.)
- D = depth of compost added (in.)

### 3.3 Compost Specifications

The compost shall be the result of the biological degradation and transformation of plant-derived materials under conditions that promote anaerobic decomposition. The material shall be well composted, free of viable weed seeds, and stable with regard to oxygen consumption and carbon dioxide generation. The compost shall have a moisture content that has no visible free water or dust produced when handling the material. It shall meet the following criteria:

- a. 100% of the material must pass through a half inch screen
- b. The pH of the material shall be between 6 and 8
- c. Manufactured inert material (plastic, concrete, ceramics, metal, etc.) shall be less than 1.0% by weight
- d. The organic matter content shall be between 35% and 65%





- e. Soluble salt content shall be less than 6.0 mmhos/cm
- f. Maturity should be greater than 80%
- g. Stability shall be 7 or less
- h. Carbon/nitrogen ratio shall be less than 25:1
- i. Trace metal test result = “pass”
- j. The compost must have a dry bulk density ranging from 40 to 50 lbs./cu.ft.

## SECTION 4: CONSTRUCTION

### 4.1 Construction Sequence

The construction sequence for compost amendments differs depending whether the practice will be applied to a large area or a narrow filter strip, such as in a rooftop disconnection or grass channel. For larger areas, a typical construction sequence is as follows:

**Step 1.** Prior to building, the proposed area should be deep tilled to a depth of 2 to 3 feet using a tractor and sub-soiler with two deep shanks (curved metal bars) to create rips perpendicular to the direction of flow. (This step is usually omitted when compost is used for narrower filter strips.)

**Step 2.** A second deep tilling to a depth of 12 to 18 inches is needed after final building lots have been graded.

**Step 3.** It is important to have dry conditions at the site prior to incorporating compost.

**Step 4.** An acceptable compost mix is then incorporated into the soil using a roto-tiller or similar equipment at the volumetric rate of 1 part compost to 2 parts soil.

**Step 5.** The site should be leveled and seeds or sod used to establish a vigorous grass cover. Lime or irrigation may initially be needed to help the grass grow quickly.

**Step 6.** Areas of compost amendments exceeding 2500 square feet should employ simple erosion control measures, such as silt fence, to reduce the potential for erosion and trap sediment.

## SECTION 5: REFERENCES

Balousek. 2003. *Quantifying decreases in stormwater runoff from deep-tilling, chisel-planting and compost amendments*. Dane County Land Conservation Department. Madison, Wisconsin.

Chollak, T. and P. Rosenfeld. 1998. *Guidelines for Landscaping with Compost-Amended Soils*. City of Redmond Public Works. Redmond, WA. Available online at: <http://www.ci.redmond.wa.us/insidecityhall/publicworks/environment/pdfs/compostamendedsoils.pdf>

*City of Franklin Stormwater Best Management Practices Manual*, City of Franklin, Stormwater Management Program, January 2014.

City of Portland. 2008. “Soil Specification for Vegetated Stormwater Facilities.” *Portland Stormwater Management Manual*. Portland, Oregon.

Composting Council (TCC). 1997. *Development of a Landscape Architect Specification for Compost Utilization*. Alexandria, VA. <http://www.cwc.org/organics/org972rpt.pdf>



Holman-Dodds, L. 2004. *Chapter 6. Assessing Infiltration-Based Stormwater Practices*. PhD Dissertation. Department of Hydrosience and Engineering. University of Iowa. Iowa City, IA.

Lenhart, J. 2007. "Compost as a Soil Amendment for Water Quality Treatment Facilities." *Proceedings: 2007 LID Conference*. Wilmington, NC.

Low Impact Development Center. *Guideline for Soil Amendments*. Available online at: <http://www.lowimpactdevelopment.org/epa03/soilamend.htm>

Roa-Espinosa. 2006. *An Introduction to Soil Compaction and the Subsoiling Practice. Technical Note*. Dane County Land Conservation Department. Madison, Wisconsin.

Soils for Salmon. 2003. *Soil Restoration and Compost Amendments*. Available online at: <http://www.soilsforsalmon.org/pdf/SoilsforSalmonLIDrev9-16-04.pdf>.



## Reforestation



## GIP - 10

### Hamilton County



### Water Quality Program

**Description:** Reforestation refers to trees planted in groups in urban areas such as: parking lots, right of ways (ROW), parks, schools, public lands, vacant land, and neighborhood open spaces, to provide shade and stormwater retention and to add aesthetic value.

#### Advantages/Benefits:

- Reduces effective impervious cover
- Reduces stormwater runoff
- Provides aesthetic value
- Provides rainfall interception
- Shade provides cooling and energy savings
- Provides habitat
- Provides pollutant removal
- Provides flow attenuation

#### Disadvantages/Limitations:

- Poor quality urban soils may require soil amendments or remediation
- Long-term maintenance is required for high tree survival rates
- Must be implemented over large areas to see significant reduction in stormwater runoff
- Time required for trees to mature
- Poor soils, improper planting methods, conflicts with paved areas and utilities, inputs from road salt, lack of water, or disease can lead to low survival rate

#### Design Considerations:

- Stormwater trees are limited to areas where there is sufficient space for fully grown trees as well as utilities and a separation distance from structures.
- Tree species with desirable stormwater control characteristics should be utilized. For trees receiving runoff, tree species must have a high tolerance for common urban pollutants. This includes salt tolerance if receiving runoff from areas treated for snow and ice. References for appropriate tree selection are included in **Table 10.2**.
- Continued on next page....

#### Selection Criteria:

**Twice the forest Rv factor for the corresponding soil type.**

**Equal to the forest Rv factor if amended soils are used in conjunction with reforestation.**

**\*This GIP is granted only in special circumstances**

#### Land Use Considerations:

- Residential
- Commercial
- Industrial

#### Maintenance:

- Trees may require irrigation in dry periods

**Maintenance Burden**  
 L = Low M = Moderate H = High





**Design Considerations Cont.:**

- Mulch can be used around trees as an added filtration mechanism. The use of amended soils results in additional credit.
- Soils and mulch play a significant role in pollutant removal and tree health. Selection of soils and mulch intended to improve stormwater controls should allow water to infiltrate into the soil, with planting soil characteristics and volume tailored to meet the needs of a healthy tree.
- If sheet flow is used to route impervious areas to reforested area, care should be taken to avoid erosion of ground cover.
- Credit is given in special circumstances.

**GIP – 10 SECTION 1: DESCRIPTION**

Site reforestation involves planting trees at a development site with the explicit goal of establishing a mature forest canopy that will intercept rainfall, increase evapotranspiration rates, and enhance soil infiltration rates.

**GIP – 10 SECTION 2: PERFORMANCE**

The overall runoff reduction credits for reforestation through lower runoff coefficients are summarized in **Table GIP-10-01**.

Table GIP-10-01. Reforestation Runoff Coefficient Credit							
Level 1 Design				Level 2 Design			
Twice the forest Rv factor for the corresponding soil type.				Equal to forest Rv factor if Amended Soils (See <b>GIP-07 A-7</b> ) are used in conjunction.			
A	B	C	D	A	B	C	D
0.04	0.06	0.08	0.10	0.02	0.03	0.04	0.05
Impervious area may be routed to the reforestation area following the guidance and applying the Runoff Coefficient Credits detailed in <b>GIP-09</b> . The reforestation area should be treated as a vegetated filter strip for the application of this GIP.							



## GIP – 10 SECTION 3: DESIGN TABLE

The overall runoff reduction credits for reforestation through lower runoff coefficients are summarized in **Table GIP-10-02**.

Table GIP-10-02. Design Specifications for Reforestation	
Item	Specifications for Level 1 and Level 2
Area	Minimum contiguous area of 5,000 sq. ft.
Tree Type	No more than 20% of any single tree species. Consider composition of local forests in planting design. 2/3 of trees must be large canopy. See the USGS landfire map for delineation of forest type and the 2006 Descriptions of Ecological Systems for Modeling of LANDFIRE Biophysical Settings Ecological Systems of location US State TN .PFD for description of species within each forest type. Links: <a href="http://landfire.cr.usgs.gov/viewer/">http://landfire.cr.usgs.gov/viewer/</a> <a href="http://www.tn.gov/environment/na/pdf/tn_eco_systems.pdf">http://www.tn.gov/environment/na/pdf/tn_eco_systems.pdf</a> <a href="http://www.se-eppc.org/pubs/middle.pdf">http://www.se-eppc.org/pubs/middle.pdf</a>
Density	<ul style="list-style-type: none"> <li>• 300 large canopy trees – species that normally achieve an overall height at maturity of thirty feet or more per acre</li> <li>• 10 shrubs substitute for 1 large canopy tree</li> <li>• 2 small canopy trees substitute for 1 large canopy tree</li> </ul> Note: Adjustments to densities may be possible with Program approval.
Canopy Rate	Achieve 75% forest canopy within first 10 years
Size	Tree - Minimum tree size 6-8 ft. in height Shrub – 18-24 inches or 3 gallon size
Ground Cover	Entire area should be covered with 2-4 inches of organic mulch or a native seed mix

Reforestation areas are eligible under the following qualifying conditions:

- ❖ The minimum contiguous area of reforestation must be greater than 5,000 square feet, with no more than 20% of the area in any single tree species. The basic density of plantings is 300 large canopy trees per acre, approximately 12 feet on center. When shrubs are substituted for trees, there must be 10 shrubs per one large canopy tree. Two small canopy trees, such as Dogwoods or Red Buds, may be substituted for one large canopy tree. Adjustments can be made to these densities for areas of urban reforestation with the approval of the Program. Reforestation should consider the composition of area forests, and two thirds of selected trees must be large canopy. Reforestation methods should achieve 75% forest canopy within ten years.
- ❖ The minimum size requirement for reforestation is saplings 6-8 feet in height. The minimum size requirement for shrubs is 18-24 inches, or 3 gallon size. In addition, the entire reforestation should be covered with 2-4 inches of organic mulch or with a native seed mix in order to help retain moisture and provide a beneficial environment for the reforestation.
- ❖ A long-term vegetation management plan must be prepared and filed with the Program in order to demonstrate the ability to maintain the reforestation area in an appropriate forest canopy condition. The plan should include a scale drawing showing the area to be planted, along with a plant list which includes species, size, number, and packaging. In addition, the reforestation area shall be clearly identified on all construction drawings and EPSC plans during construction.



- ❖ The reforestation area must be protected by a perpetual stormwater easement or deed restriction which stipulates that no future development or disturbance may occur within the area.
- ❖ The planting plan must be approved by the Program, including any special site preparation needs.
- ❖ The construction contract should contain a care and replacement warranty extending at least two growing seasons, to ensure adequate growth and survival of the plant community.
- ❖ The final size of the trees should be considered when designing the planting plan. Tennessee One-Call (811) must be contacted prior to the submission of the planting plan to ensure that no utilities will be impacted by the tree planting. The planting plan must also avoid placing trees under overhead utilities.
- ❖ If using the reforestation area as a vegetated filter strip to receive additional credit under **GIP-09**, follow all GIP design criteria and insure that additional routed runoff does not cause erosion or degrade the quality of ground cover.

## GIP – 10 SECTION 4: DESIGN CONSIDERATIONS

Trees are often one of the most economical stormwater BMPs that can be introduced into urban ROWs. Tree canopies intercept rainfall before it becomes stormwater and the tree boxes into which trees are planted can be used to capture and treat runoff. Trees also reduce the urban heat island effect, improve the urban aesthetic and improve air quality. Data and modeling show that urban trees can remove over 50% of the moisture in the soil beneath their canopy. Refer to **Table GIP-10-02** for native tree species. A list of native trees is also provided in **GIP-01 Table GIP-01-07**.

Tree plantings within the ROW must receive approval from Public Works. Vacant residential lots also provide reforestation opportunities. These lots can become an urban forest and an amenity to a neighborhood. Vegetation management plans must account for Health Department codes regarding overgrown lots and safety concerns of the residents. Special criteria for reforesting empty residential lots include:

- ❖ The area between curb and sidewalk and a 10 foot wide buffer adjacent to the sidewalk (away from the street) shall be kept mowed and clear.
- ❖ While the trees are being established, mowing is permitted between the trees. Eventually, the canopy should shade out the grass and forest undergrowth will be established. Vegetation management plans should consider if residents would prefer the site mowed in perpetuity.



Figure GIP-10-01 Tree Planting Event





## GIP – 10 SECTION 5: DESIGN CRITERIA

Level 1 Reforestation involves using soil types currently on a site, without soil amendments. Current soil should be preserved from compaction and disturbance during construction and should be clearly identified on all construction drawings and EPSC plans. Trees should be planted following tree selection criteria in **Table 10.2**. Use **Table GIP-10-01** to find  $R_v$  factors for Level 1 which equal twice the forested area  $R_v$  factors.

Level 2 Reforestation requires the use of amended soils. Soil Amendment guidance is located in **GIP-07 A-7**. This area is then treated as original forested area for calculation purposes. Level 2 design allows for use of Forested  $R_v$  factors as shown in **Table GIP-10-01**.

For both levels, once the forest area  $R_v$  is determined continue through the design process with weighted  $R_v$  calculations (**Equation 7**) located in **Section 2.3.3** of the BMP manual.

## GIP – 10 SECTION 6: MAINTENANCE

Each BMP must have a Hamilton County Water Quality Stormwater Management Facility I&M Storm Water Management Facilities Agreement submitted for approval and maintained and updated by the BMP owner. The Stormwater Management Facilities I&M Agreement must be completed and submitted to the Program with the Land Disturbance permit application. The Stormwater Management Facilities I&M Agreement is for the use of the BMP owner in performing routine inspections. The developer/owner is responsible for the cost of maintenance and annual inspections. The BMP owner must maintain and update the BMP inspections and maintenance plan.

Mowing is permitted but not encouraged between the trees while they are being established. Eventually, the canopy should shade out the grass and forest undergrowth will be established removing the need to mow. Vegetation management plans should be considered if residents would prefer that the site is mowed in perpetuity.

Additional maintenance activities include:

- ❖ Watering the trees as needed during dry periods
- ❖ Repairing areas of erosion or reseeding areas that are bare
- ❖ Removing trash and debris from area
- ❖ Replanting any trees that die throughout the year. (The construction contract should contain a care and replacement warranty extending at least two growing seasons, to ensure adequate growth and survival of the plant community.)
- ❖ Addressing areas of standing water which might breed mosquitoes
- ❖ Picking up branches that have fallen
- ❖ Grooming trees or shrubs as needed
- ❖ Removing any trees or limbs damaged in storms that might pose a danger.



## GIP – 10 SECTION 7: REFERENCES

Balousek. 2003. Quantifying decreases in stormwater runoff from deep-tilling, chisel-planting and compost amendments. Dane County Land Conservation Department. Madison, Wisconsin.

Chollak, T. and P. Rosenfeld. 1998. Guidelines for Landscaping with Compost-Amended Soils. City of Redmond Public Works. Redmond, WA. Available online at:

<http://www.ci.redmond.wa.us/insidecityhall/publicworks/environment/pdfs/compostamendedsoils.pdf>.

City of Chesapeake. 2010. Chesapeake Landscape Specifications Manual: Tree and Shrub Planting Guidelines. Approved on October 16, 2008 and amended effective August 1, 2010. Available online at:

[http://www.chesapeake.va.us/services/depart/planning/pdf/ord-Landscape-Specifications-Manual\\_adopted-0901608.pdf](http://www.chesapeake.va.us/services/depart/planning/pdf/ord-Landscape-Specifications-Manual_adopted-0901608.pdf).

City of Franklin, Stormwater Management Program. January 2014. *City of Franklin Stormwater Best Management Practices Manual*.

City of Portland. 2008. "Soil Specification for Vegetated Stormwater Facilities." Portland Stormwater Management Manual. Portland, Oregon.

Virginia Dept. of Conservation and Recreation. 2010. Design Specification No. 4: Soil Compost Amendment Version 1.7, Appendix 4-A, Initial Minimum Design Criteria for Reforestation, Disconnection, Filter Strips, and Grass Channels. Available online at: <http://csnetwork.squarespace.com/all-things-stormwater/soil-compost-amendments.html>.



## Rain Tank / Cistern



## GIP - 11

### Hamilton County



### Water Quality Program

**Description:** Rain tanks and cisterns are used to intercept, divert, store and release rain falling on rooftops for future use; may be located aboveground or underground.

#### Components:

- Roof surface
- Collection and conveyance system
- Pre-screening and first flush diverter
- Storage tank
- Distribution system
- Overflow, filter path or secondary runoff reduction practice

#### Advantages/Benefits:

- Water source for non-potable uses (toilet flushing, irrigation)

#### Disadvantages/Limitations:

- Systems must drain between storm events

#### Design considerations:

- Underground storage tanks must be above groundwater level
- Certain roof materials may leach metals or hydrocarbons, limiting potential uses for harvested rainwater
- Underground tanks should be set at least 10 feet from building foundations
- Cistern overflows should be designed to avoid soil saturation within 10 feet of building foundations
- Systems must be designed for consistent drawdown year-round
- Aboveground storage tanks should be UV resistant and opaque to inhibit algae growth
- Underground storage tanks must be designed to support anticipated loads
- Hookups to municipal backup water supplies must be equipped with backflow prevention devices

#### Additional Considerations:

- Continued on next page....

#### Selection Criteria:

**Up to 90% Runoff Reduction Credit**

#### Land Use Considerations:

Residential

Commercial

Industrial

#### Maintenance:

- Gutters and downspouts should be kept clean and free of debris and rust.
- Annual inspection

H

**Maintenance Burden**

L = Low M = Moderate H = High





Additional Considerations cont.....

#### Roof Surface

- The rooftop should be made of smooth, non-porous material with efficient drainage either from a sloped roof or an efficient roof drain system.

#### Collection and Conveyance System

- Gutters and downspouts should be designed as they would for a building without a rainwater harvesting system.
- Gutters should be sized with slopes specified to contain the necessary amount of stormwater for treatment volume credit.
- Pipes (connecting downspouts to the cistern tank) should be at a minimum slope of 1.5% and sized/constructed to convey the intended design storm.

#### Pre-Screening and First Flush Diverter

- Inflow must be pre-screened to remove leaves, sediment, and other debris.
- For large systems, the first flush (0.02 – 0.06 inches) of rooftop runoff should be diverted to a secondary treatment practice to prevent sediment from entering the system.
- Rooftop runoff should be filtered to remove sediment before it is stored.

#### Storage Tank

- Storage tanks are sized based on consideration of indoor and outdoor water demand, long-term rainfall and rooftop capture area.

#### Distribution System

- The rainwater harvesting system should be equipped with an appropriately-sized pump that produces sufficient pressure for all end-uses.
- Distribution lines should be installed with shutoff valves and cleanouts, and should be buried beneath the frost line or insulated to prevent freezing.

#### Overflow

- The system must be designed with an overflow mechanism to divert runoff when the storage tanks are full.
- Overflows should discharge to pervious areas set back from buildings and paved surfaces, or to secondary BMPs.

## GIP – 11 SECTION 1: DESCRIPTION

A cistern intercepts, diverts, stores and releases rainfall for future use. The term cistern is used in this specification, but it is also known as a rainwater harvesting system. Rainwater that falls on a rooftop is collected and conveyed into an above- or below-ground storage tank where it can be used for non-potable water uses and on-site stormwater disposal/infiltration. Non-potable uses may include flushing of toilets and urinals inside buildings, landscape irrigation, exterior washing (e.g. car washes, building facades, sidewalks, street sweepers, fire trucks, etc.), supply for chilled water cooling towers, replenishing and operation of laundry, if approved by the Program.

In many instances, rainwater harvesting can be combined with a secondary (down-gradient) runoff reduction practice to enhance runoff volume reduction rates and/or provide treatment of overflow from the rainwater harvesting system. Some candidate secondary practices include:

- ❖ Downspout Disconnection: GIP-07 (excluding rain tanks and cisterns). This may include release to a compost-amended filter path



- ❖ Sheet Flow to a Vegetated Filter Strip or Conserved Open Space: GIP-09
- ❖ Grass Channel: GIP-08
- ❖ Infiltration Trench: GIP-04
- ❖ Bioretention: GIP-01
- ❖ Urban Bioretention: GIP-02. Storage and release in a foundation planter.
- ❖ Water Quality Swale: GIP-05

**GIP – 11 Section 5.3** (Physical Feasibility & Design Applications) provides more detail on system configurations, including the use of secondary practices.

In addition, the actual runoff reduction rates for rainwater harvesting systems are “user defined,” based on tank size, configuration, demand drawdown, and use of secondary practices.

## GIP – 11 SECTION 2: PERFORMANCE

The overall stormwater functions of the rainwater harvesting systems are described in **Table GIP-11-01**.

Table GIP-11-01: Runoff Volume Reduction Provided by Rainwater Harvesting	
Stormwater Function	Performance
Runoff Volume Reduction (RR)	Variable up to 90% <sup>1</sup>

<sup>1</sup> Credit is variable. Credit up to 90% is possible if all water from storms with rainfall of 1 inch or less is used through demand, and the tank is sized such that no overflow from this size event occurs. The total credit may not exceed 90%.

## GIP – 11 SECTION 3: DESIGN

Rainwater harvesting system design does not have a design table. Runoff reduction credits are based on the total amount of annual internal water reuse, outdoor water reuse, and tank dewatering discharge calculated to be achieved by the tank system.

## GIP – 11 SECTION 4: TYPICAL DETAILS

**Figures GIP-11-01 through GIP-11-03** of **Section 5.3** provide typical schematics of cistern and piping system configurations, based on the design objectives (year-round internal use, external seasonal irrigation, etc.).

**Figures GIP-11-04 through GIP-11-06** of **Section 5.4** provide typical schematics of Cistern tank configurations, based on the desired Treatment Volume and stormwater management objectives (Treatment Volume only, channel protection, etc.).

## GIP – 11 SECTION 5: PHYSICAL FEASIBILITY & DESIGN APPLICATIONS

A number of site-specific features influence how rainwater harvesting systems are designed and/or utilized. These should not be considered comprehensive and conclusive considerations, but rather some recommendations that should be considered during the process of planning to incorporate rainwater harvesting systems into the site design. The following are key considerations:



## 5.1 Site Conditions

**Available Space.** Adequate space is needed to house the tank and any overflow. Space limitations are rarely a concern with rainwater harvesting systems if they are considered during the initial building design and site layout of a residential or commercial development. Storage tanks can be placed underground, indoors, on rooftops or within buildings that are structurally designed to support the added weight, and adjacent to buildings. Designers can work with Architects and Landscape Architects to creatively site the tanks. Underground utilities or other obstructions should always be identified prior to final determination of the tank location.

**Site Topography.** Site topography and tank location should be considered as they relate to all of the inlet and outlet invert elevations in the rainwater harvesting system. The total elevation drop will be realized beginning from the downspout leaders to the final mechanism receiving gravity-fed discharge and/or overflow from the cistern.

These elevation drops will occur along the sloping lengths of the underground roof drains from roof drain leader downspouts at the building all the way to the cistern. A vertical drop occurs within the filter before the cistern. The cistern itself must be located sufficiently below grade and below the frost line, resulting in an additional elevation drop. When the cistern is used for additional volume detention for channel and/or flood protection, an orifice may be included with a low invert specified by the designer. An overflow will always be present within the system, with an associated invert. Both the orifice (if specified) and the overflow will drain the tank during large storms, routing this water through an outlet pipe, the length and slope of which will vary from one site to another.

All these components of the rainwater harvesting system have an elevation drop associated with them. The final invert of the outlet pipe must match the invert of the receiving mechanism (natural channel, storm drain system, etc.) that receives this overflow. These elevation drops and associated inverts should be considered early in the design, in order to ensure that the rainwater harvesting system is feasible for the particular site.

Site topography and tank location will also affect the amount of pumping needed. Locating storage tanks in low areas will make it easier to route roof drains from buildings to cisterns. However, it will increase the amount of pumping needed to distribute the harvested rainwater back into the building or to irrigated areas situated on higher ground. Conversely, placing storage tanks at higher elevations may require larger diameter roof drains with smaller slopes. However, this will also reduce the amount of pumping needed for distribution. In general, it is often best to locate the cistern close to the building, ensuring that minimum roof drain slopes and enclosure of roof drain pipes are sufficient.

**Available Hydraulic Head.** The required hydraulic head depends on the intended use of the water. For residential landscaping uses, the cistern should be sited up-gradient of the landscaping areas or on a raised stand. Pumps are commonly used to convey stored rainwater to the end use in order to provide the required head. When the water is being routed from the cistern to the inside of a building for non-potable use, often a pump is used to feed a much smaller pressure tank inside the building which then serves the internal demands through gravity-fed head. Cisterns can also use gravity- to accomplish indoor residential uses (e.g., laundry) that do not require high water pressure. In cases where cisterns are located on building roofs in order to operate under gravity-fed conditions, the structure must be designed to provide for the added weight of the rainwater harvesting system and stored water.





**Water Table.** Underground storage tanks are most appropriate in areas where the tank can be buried *above* the water table. The tank should be located in a manner that will not subject it to flooding. In areas where the tank is to be buried partially below the water table, special design features must be employed, such as sufficiently securing the tank (to keep it from “floating”), conducting buoyancy calculations when the tank is empty, etc. The tank may need to be secured appropriately with fasteners or weighted to avoid uplift buoyancy. The tank must also be installed according to the tank manufacturer’s specifications.

**Soils.** The bearing capacity of the soil upon which the cistern will be placed should be considered, as full cisterns can be very heavy. Storage tanks should only be placed on native soils or on fill in accordance with the manufacturer's guidelines, or in consultation with a geotechnical engineer. This is particularly important for above-ground cisterns, as significant settling could cause the cistern to lean or in some cases to potentially topple. A sufficient aggregate, or concrete base, may be appropriate depending on the soils. Cistern supplies may also need a pH adjustment, since rainwater may be corrosive towards metals in the system if the pH is less than 6.5.

**Proximity of Underground Utilities.** All underground utilities must be taken into consideration during the design of underground rainwater harvesting systems, treating all of the rainwater harvesting system components and storm drains as typical stormwater facilities and pipes. The underground utilities must be marked and avoided during the installation of underground tanks and piping associated with the system. Appropriate minimum setbacks from septic drainfields should be observed. Before digging, call Tennessee One-Call (811) to get underground utility lines marked.

**Contributing Drainage Area.** The contributing drainage area (CDA) to the cistern is the impervious area draining to the tank. In general, only rooftop surfaces should be included in the CDA. Areas of any size, including portions of roofs, can be used based on the sizing guidelines in this design specification. Runoff should be routed directly from rooftops to rainwater harvesting systems in closed roof drain systems or storm drain pipes, avoiding surface drainage, which could allow for increased contamination of the water.

**Rooftop Material.** The quality of the harvested rainwater will vary according to the roof material over which it flows. Water harvested from certain types of rooftops, such as asphalt sealcoats, tar and gravel, painted roofs, galvanized metal roofs, sheet metal or any material that may contain asbestos may leach trace metals and other toxic compounds. In general, harvesting rainwater from such roofs should be avoided, unless new information determines that these materials are sufficient for the intended use and are allowed by the Program. If a sealant or paint roof surface is desired, it is recommended to use one that has been certified for such purposes by the National Sanitation Foundation (ANSI/NSF standard).

**Water Quality of Rainwater.** Designers should also note that the *pH* of rainfall in the eastern United States tends to be acidic (ranging from 4.5 to 5.0), which may result in leaching of metals from the roof surface, tank lining or water laterals to interior connections. Once rainfall leaves rooftop surfaces, pH levels tend to be slightly higher, ranging from 5.5 to 6.0. Limestone or other materials may be added in the tank to buffer acidity, if desired.

**Hotspot Land Uses.** Harvesting rainwater can be an effective method to prevent contamination of rooftop runoff that would result from mixing it with ground-level runoff from a stormwater hotspot operation. In some cases, however, industrial roof surfaces may also be designated as stormwater hotspots.

**Setbacks from Buildings.** Cistern overflow devices should be designed to avoid causing ponding or soil saturation within 10 feet of building foundations. Storage tanks should be designed to be watertight to prevent water damage when placed near building foundations. In general, it is recommended that underground tanks be set at least 10 feet from any building foundation.



**Vehicle Loading.** Whenever possible, underground rainwater harvesting systems should be placed in areas without vehicle traffic or be designed to support live loads from heavy trucks, a requirement that may significantly increase construction costs.

## 5.2 Stormwater Uses

The capture and reuse of rainwater can significantly reduce stormwater runoff volumes and pollutant loads. By providing a reliable and renewable source of water to end users, rainwater harvesting systems can also have environmental and economic benefits beyond stormwater management (e.g., increased water conservation, water supply during drought and mandatory municipal water supply restrictions, decreased demand on municipal or groundwater supply, decreased water costs for the end-user, potential for increased groundwater recharge, etc). To enhance their runoff reduction and nutrient removal capability, rainwater harvesting systems can be combined with other rooftop disconnection practices, such as infiltration trenches (GIP-04) and bioretention or foundation planters (GIP-01 and GIP-02). In this specification, these allied practices are referred to as “secondary runoff reduction practices.”

While the most common uses of captured rainwater are for non-potable purposes, such as those noted above, in some limited cases rainwater can be treated to potable standards.

## 5.3 Design Objectives and System Configurations

Many rainwater harvesting system variations can be designed to meet user demand and stormwater objectives. This specification focuses on providing a design framework for addressing the Treatment Volume ( $T_v$ ) objectives. From a rainwater harvesting standpoint, there are numerous potential configurations that could be implemented. However, in terms of the goal of addressing the design treatment volume, this specification adheres to the following concepts in order to properly meet the stormwater volume reduction goals:

- ❖ Credit is only available for dedicated year-round drawdown/demand for the water. While seasonal practices (such as irrigation) may be incorporated into the site design, they are not considered to contribute to the treatment volume credit (for stormwater purposes) unless a drawdown at an equal or greater rate is also realized during non-seasonal periods (e.g. treatment in a secondary runoff reduction practice during non-irrigation months).
- ❖ System design is encouraged to use rainwater as a resource to meet on-site demand or in conjunction with other runoff reduction practices (especially those that promote groundwater recharge).
- ❖ Pollutant load reduction is realized through reduction of the volume of runoff leaving the site.
- ❖ Peak flow reduction is realized through reduced volume and temporary storage of runoff.

Therefore, the rainwater harvesting system design configurations presented in this specification are targeted for continuous (year-round) use of rainwater through (1) internal use, and (2) irrigation and/or treatment in a secondary practice. Three basic system configurations are described below.

**Configuration 1: Year-round indoor use with optional seasonal outdoor use (Figure GIP-11-01).** The first configuration is for year round indoor use along with optional seasonal outdoor use, such as irrigation. Because there is no on-site secondary runoff reduction practice incorporated into the design for non-seasonal (or non-irrigation) months, the system must be designed and treatment volume awarded for the interior use only. (However, it should be noted that the seasonal irrigation will provide an economic benefit in terms of water usage). Stormwater credit can be enhanced by adding a secondary runoff reduction practice (see Configuration 3 below).

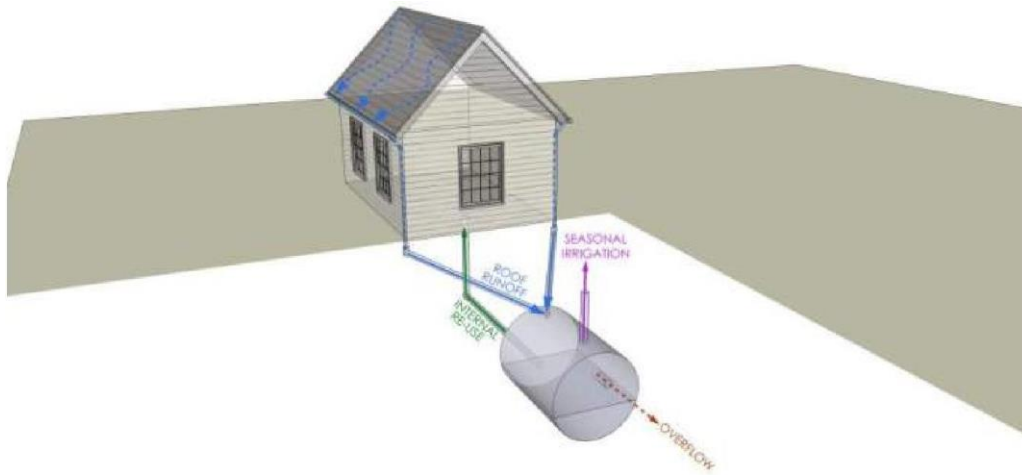


Figure GIP-11-01. Configuration 1: Year-round indoor use with optional seasonal outdoor use  
(Source: VADCR, 2011)

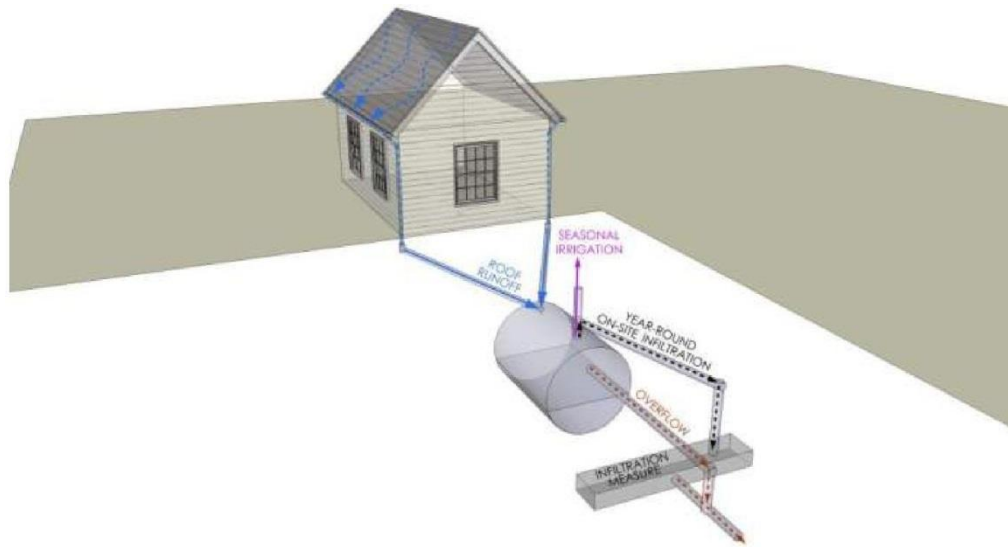


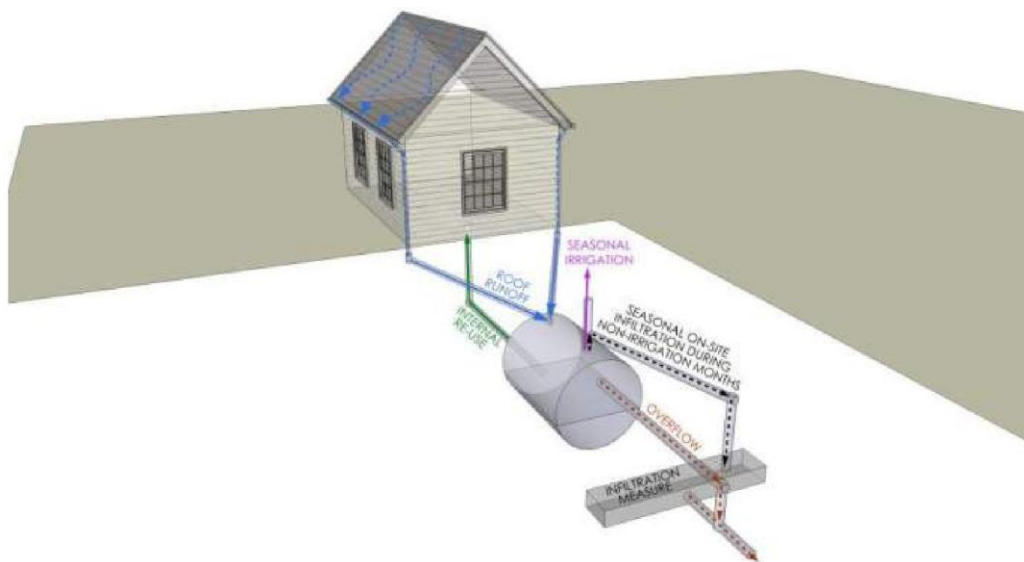
Figure GIP-11-02. Configuration 2: Seasonal outdoor use and approved year-round secondary practice  
(Source: VADCR, 2011)





**Configuration 2: Seasonal outdoor use and approved year-round secondary runoff reduction practice (Figure GIP-11-02).** The second configuration uses stored rainwater to meet a seasonal or intermittent water use, such as irrigation. However, because these uses are only intermittent or seasonal, this configuration also relies on an approved secondary practice for stormwater credit. Compared to a stand-alone BMP (without the upgradient tank), the size and/or storage volume of the secondary practice can be reduced based on the storage in the tank. The tank's drawdown and release rate should be designed based on the infiltration properties, surface area, and capacity of the receiving secondary runoff reduction practice. The release rate therefore is typically much less than the flow rate that would result from routing a detention facility. The secondary practice should serve as a "backup" facility, especially during non-irrigation months. In this regard, the tank should provide some meaningful level of storage and reuse, accompanied by a small flow to the secondary practice. This is especially important if the size and/or storage volume of the secondary practice is reduced compared to using that practice in a "stand-alone" design (i.e., without an upgradient cistern). See **Section 5.4 Tank Design 3** for more information.

**Configuration 3: Year-round indoor use, seasonal outdoor irrigation, and non-seasonal treatment in a secondary runoff reduction practice (Figure GIP-11-03).** The third configuration provides for a year-round internal non-potable water demand, and a seasonal outdoor, automated irrigation system demand. In addition, this configuration incorporates a secondary practice during non-irrigation (or non-seasonal) months in order to yield a greater stormwater credit. In this case, the drawdown due to seasonal irrigation must be compared to the drawdown due to water released to the secondary practice. The minimum of these two values is used for system modeling and stormwater credit purposes.



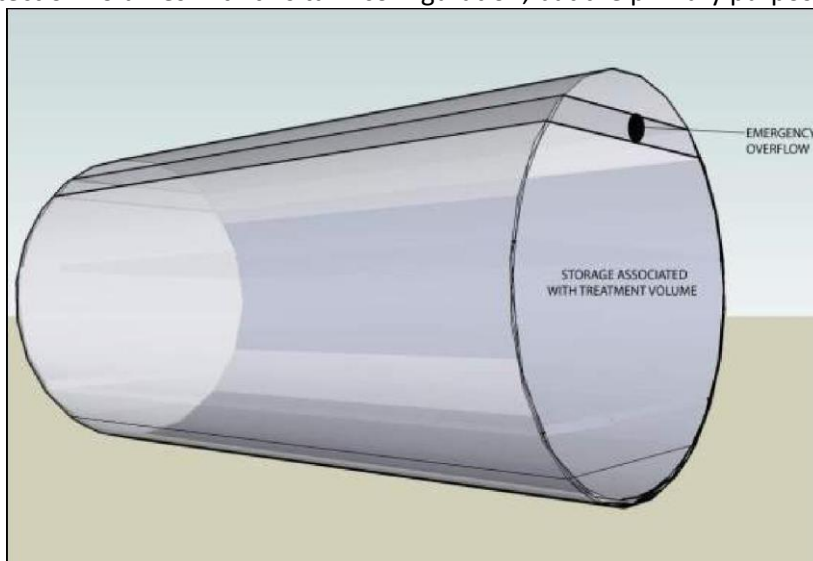
**Figure GIP-11-03. Configuration 3: Year-round indoor use, seasonal outdoor irrigation, and non-seasonal on-site treatment in secondary practice (Source: VADCR, 2011)**



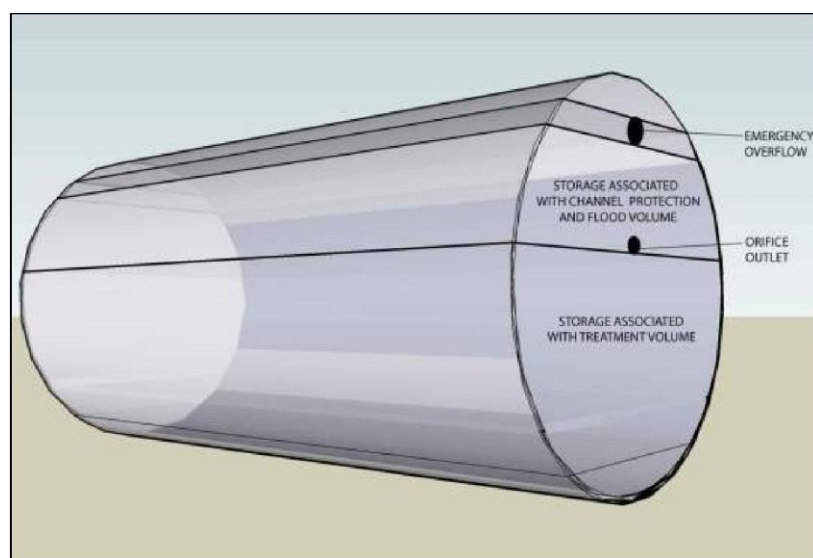
### 5.4 Design Objectives and Tank Design Set-Ups

Pre-fabricated rainwater harvesting cisterns typically range in size from 250 to over 30,000 gallons. There are three basic tank design configurations used to meet the various rainwater harvesting system configurations that are described in GIP-11 **Section 5.3**.

**Tank Design 1.** The first tank set-up (**Figure GIP-11-04**) maximizes the available storage volume associated with the Treatment Volume ( $T_v$ ) to meet the desired level of treatment credit. This layout also maximizes the storage that can be used to meet a demand. An emergency overflow exists near the top of the tank as the only gravity release outlet device (not including the pump, manway or inlets). It should be noted that it is possible to address channel and flood protection volumes with this tank configuration, but the primary purpose is to address  $T_v$ .



**Figure GIP-11-04. Tank Design 1: Storage Associated with Treatment Volume ( $T_v$ ) only**  
(Source: VADCR, 2011)



**Figure GIP-11-05. Tank Design 2: Storage Associated with Treatment, Channel Protection and Flood Volume**  
(Source: VADCR, 2011)

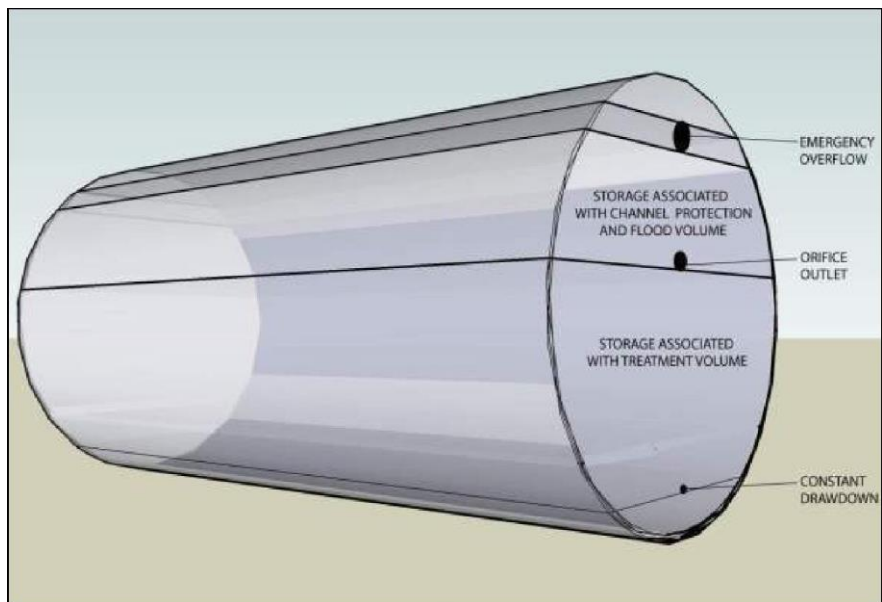


**Tank Design 2.** The second tank set-up (**Figure GIP-11-05**) uses tank storage to meet the Treatment Volume ( $T_v$ ) objectives as well as using an additional detention volume above the treatment volume space to also meet some, or all, of the channel and/or flood protection volume requirements. An orifice outlet is provided at the top of the design storage for the  $T_v$  storage level, and an emergency overflow is located at the top of the detention volume level. This specification only addresses the storage for the  $T_v$ . However, it may possible to model and size the Channel Protection and Flood Protection (detention) volumes.

**Tank Design 3.** The third tank set-up (**Figure GIP-11-06**) creates a constant drawdown within the system. The small orifice at the bottom of the tank needs to be routed to an appropriately designed secondary practice (e.g., rain garden, micro-scale infiltration, urban bioretention, etc.) that will allow the rainwater to be treated and allow for groundwater recharge over time. The release should not be discharged to a receiving channel or storm drain without treatment, and maximum specified drawdown rates from this constant drawdown should be adhered to, since the primary function of the system is not intended to be detention.

For the purposes of this tank design, the secondary practice must be considered a component of the rainwater harvesting system with regard to the runoff reduction percentage. In other words, the runoff reduction associated with the secondary practice must not be added (or double-counted) to the rainwater harvesting percentage. The reason for this is that the secondary practice is an integral part of a rainwater harvesting system with a constant drawdown. The exception to this would be if the secondary practice were also sized to capture and treat impervious area beyond the area treated by rainwater harvesting (for instance, the adjacent yard or a driveway). In this case, only these additional areas should be added to receive credit for the secondary practice.

While a small orifice is shown at the bottom of the tank in **Figure GIP-11-06**, the orifice could be replaced with a pump that would serve the same purpose, conveying a limited amount of water to a secondary practice on a routine basis.



**Figure GIP-11-06. Tank Design 3: Constant drawdown, Storage Associated with Treatment, Channel Protection and Flood Volume**  
(Source: VADCR, 2011)





### 5.5. On-Site Treatment in a Secondary Practice

Recent rainwater harvesting system design materials do not include guidance for on-site stormwater infiltration or “disposal”. The basic approach is to provide a dedicated secondary runoff reduction practice on-site that will ensure water within the tank will gradually drawdown at a specified design rate between storm events. Secondary runoff reduction practices may include the following:

- ❖ Downspout Disconnection (GIP-07), excluding rain tanks and cisterns. This may include release to a compost-amended filter path.
- ❖ Sheet Flow (GIP-09)
- ❖ Grass Channel (GIP-08)
- ❖ Infiltration Trench (GIP-04)
- ❖ Bioretention (GIP-01)
- ❖ Urban Bioretention (GIP-02). Storage and release in foundation planter.
- ❖ Water Quality Swale (GIP-05)

The secondary practice approach is useful to help achieve the desired treatment volume when demand is not enough to sufficiently draw water levels in the tank down between storm events. Of course, if demand for the harvested rainwater is relatively high, then a secondary practice may not be needed or desired.

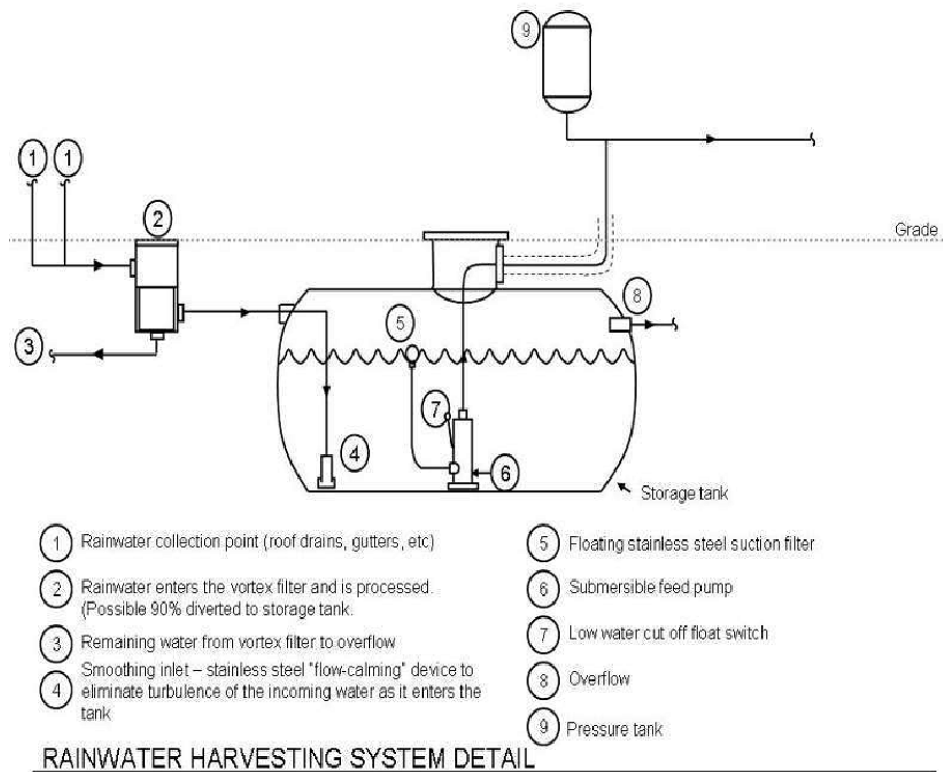
Use of a secondary practice may be particularly beneficial to employ in sites that use captured rainwater for irrigation during part of the year, but have no other use for the water during non-irrigation months. During non-irrigation months, credit cannot be realized unless on-site infiltration/treatment or another drawdown mechanism creates a year-round drawdown, since no stormwater benefit would be realized during non-seasonal periods.

The design of the secondary practice should account for soil types, ground surface areas, release rates, methods of conveyance (gravity fed or pumped), time periods of operation, and invert elevations to determine the disposal rate and sizing of the practice (both storage volume and surface area).

### 5.6 System Components

There are six primary components of a rainwater harvesting system (**Figure GIP-11-07**):

1. Roof surface
2. Collection and conveyance system (e.g. gutter and downspouts)
3. Pre-screening and first flush diverter
4. Storage tank
5. Distribution system
6. Overflow, filter path or secondary runoff reduction practice



**Figure GIP-11-07. Sample Rainwater Harvesting System Detail**  
 (Source: VADCR, 2011)

Each of these system components is discussed below.

**Rooftop Surface.** The rooftop should be made of smooth, non-porous material with efficient drainage either from a sloped roof or an efficient roof drain system. Slow drainage of the roof leads to poor rinsing and a prolonged first flush, which can decrease water quality. If the harvested rainwater is selected for uses with significant human exposure (e.g. pool filling, watering vegetable gardens), care should be taken in the choice of roof materials. Some materials may leach toxic chemicals making the water unsafe for humans.

**Collection and Conveyance System.** The collection and conveyance system consists of the gutters, downspouts and pipes that channel stormwater runoff into storage tanks. Gutters and downspouts should be designed as they would for a building without a rainwater harvesting system. Aluminum, round-bottom gutters and round downspouts are generally recommended for rainwater harvesting. Minimum slopes of gutters should be specified. At a minimum, gutters should be sized with slopes specified to contain the 1-inch storm at a rate of 1-inch/hour for treatment volume credit. If volume credit will also be sought for channel and flood protection, the gutters should be designed to convey the 2 and 10-year storm, using the appropriate 2 and 10 year storm intensities, specifying size and minimum slope. In all cases, gutters should be hung at a minimum of 0.5% for 2/3 of the length and at 1% for the remaining 1/3 of the length.

Pipes (connecting downspouts to the cistern tank) should be at a minimum slope of 1.5% and sized/designed to convey the intended design storm, as specified above. In some cases, a steeper slope and larger sizes may be



recommended and/or necessary to convey the required runoff, depending on the design objective and design storm intensity. Gutters and downspouts should be kept clean and free of debris and rust.

**Pre-Treatment: Screening, First Flush Diverters and Filter Efficiencies.** Pre-filtration is required to keep sediment, leaves, contaminants and other debris from the system. Leaf screens and gutter guards meet the minimal requirement for pre-filtration of small systems, although direct water filtration is preferred. All pre-filtration devices should be low-maintenance or maintenance-free. The purpose of pre-filtration is to significantly cut down on maintenance by preventing organic buildup in the tank, thereby decreasing microbial food sources.

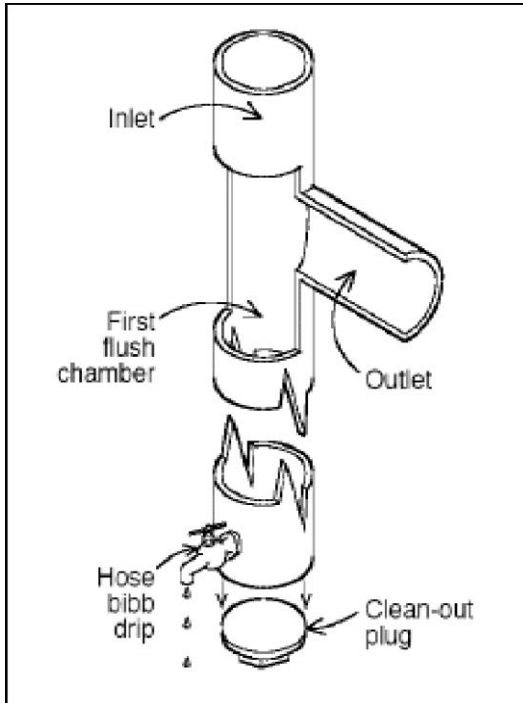
For larger tank systems, the initial first flush must be diverted from the system before rainwater enters the storage tank. Designers should note that the term “first flush” in rainwater harvesting design does not have the same meaning as has been applied historically in the design of stormwater treatment practices. In this specification, the term “first flush diversion” is used to distinguish it from the traditional stormwater management term “first flush”. The amount can range between the first 0.02 to 0.06 inches of rooftop runoff.

The diverted flows (first flush diversion and overflow from the filter) must be directed to an acceptable pervious flow path that will not cause erosion during a 2-year storm or to an appropriate BMP on the property, for infiltration. Preferably the diversion will be conveyed to the same secondary runoff reduction practice that is used to receive tank overflows.

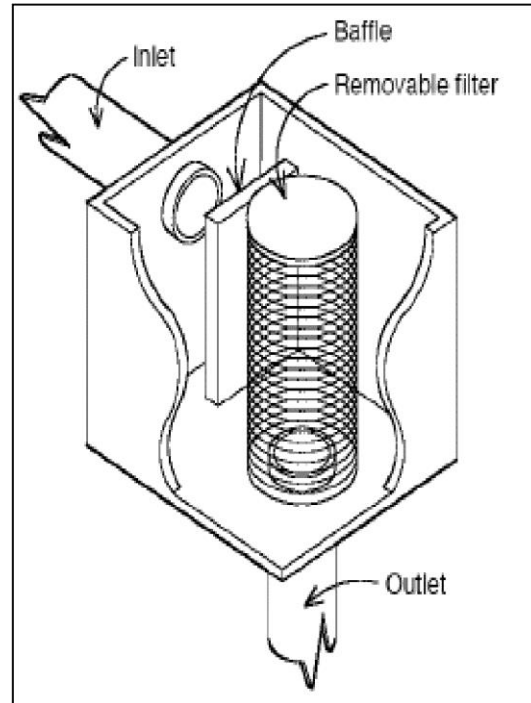
Various first flush diverters are described below. In addition to the initial first flush diversion, filters have an associated efficiency curve that estimates the percentage of rooftop runoff that will be conveyed through the filter to the storage tank. If filters are not sized properly, a large portion of the rooftop runoff may be diverted and not conveyed to the tank at all. A design intensity of 1-inch/hour should be used for the purposes of sizing pre-tank conveyance and filter components. This design intensity captures a significant portion of the total rainfall during a large majority of rainfall events (NOAA 2004). If the system will be used for channel and flood protection, the 2- and 10-year storm intensities should be used for the design of the conveyance and pre-treatment portion of the system. For the 1-inch storm treatment volume, a minimum of 95% filter efficiency is required. This efficiency includes the first flush diversion. For the 2- and 10-year storms, a minimum filter efficiency of 90% should be met.

- ❖ **First Flush Diverters.** First flush diverters direct the initial pulse of stormwater runoff away from the storage tank. While leaf screens effectively remove larger debris such as leaves, twigs and blooms from harvested rainwater, first flush diverters can be used to remove smaller contaminants such as dust, pollen and bird and rodent feces (**Figure GIP-11-8**). Simple first flush diverters require active management, by draining the first flush water volume to a pervious area following each rainstorm. First flush diverters may be the preferred pretreatment method if the water is to be used for indoor purposes. A vortex filter may serve as an effective pre-tank filtration device and first flush diverter.
- ❖ **Leaf Screens.** Leaf screens are mesh screens installed over either the gutter or downspout to separate leaves and other large debris from rooftop runoff. Leaf screens must be regularly cleaned to be effective; if not maintained, they can become clogged and prevent rainwater from flowing into the storage tanks. Built-up debris can also harbor bacterial growth within gutters or downspouts (TWDB, 2005).
- ❖ **Roof Washers.** Roof washers are placed just ahead of storage tanks and are used to filter small debris from harvested rainwater (**Figure GIP-11-9**). Roof washers consist of a tank, usually between 25 and 50 gallons in size, with leaf strainers and a filter with openings as small as 30-microns (TWDB, 2005). The filter functions to remove very small particulate matter from harvested rainwater. All roof washers must be cleaned on a regular basis.





**Figure 11.8 First Flush Diverter**  
(Source: VADCR, 2011)



**Figure 11.9 Roof Washer**  
(Source: VADCR, 2011)

- ❖ **Vortex Filters.** For large scale applications, vortex filters can provide filtering of rooftop rainwater from larger rooftop areas. Two images of the vortex filter are displayed below. The first image (**Figure 11.10**) provides a plan view photograph showing the interior of the filter with the top off. The second image (**Figure GIP1-11**) displays the filter just installed in the field prior to the backfill.



**Figure GIP11-10. Interior of Vortex  
(Source: VADCR, 2011)Filter**



**Figure GIP11-10. Interior of Vortex  
(Source: VADCR, 2011)Filter**



**Storage Tanks.** The storage tank is the most important and typically the most expensive component of a rainwater harvesting system. Cistern capacities range from 250 to over 30,000 gallons. Multiple tanks can be placed adjacent to each other and connected with pipes to balance water levels and increase overall storage on-site as needed. Typical rainwater harvesting system capacities for residential use range from 1,500 to 5,000 gallons. Storage tank volumes are calculated to meet the water demand and stormwater treatment volume objectives, as described in **Section 6** of this specification.

While many of the graphics and photos in this specification depict cisterns with a cylindrical shape, the tanks can be made of many materials and configured in various shapes, depending on the type used and the site conditions where the tanks will be installed. For example, configurations can be rectangular, L-shaped or step vertically to match the topography of a site. The following factors that should be considered when designing a rainwater harvesting system and selecting a storage tank:

- ❖ Aboveground storage tanks should be UV and impact resistant.
- ❖ Underground storage tanks must be designed to support the overlying sediment and any other anticipated loads (e.g., vehicles, pedestrian traffic, etc.).
- ❖ Underground rainwater harvesting systems should have a standard size manhole or equivalent opening to allow access for cleaning, inspection, and maintenance purposes. This access point should be secured/locked to prevent unwanted access.
- ❖ All rainwater harvesting systems should be sealed using a water-safe, non-toxic substance.
- ❖ Rainwater harvesting systems may be ordered from a manufacturer or can be constructed on site from a variety of materials. **Table GIP-11-02** below compares the advantages and disadvantages of different storage tank materials.
- ❖ Storage tanks should be opaque or otherwise protected from direct sunlight to inhibit algae growth and should be screened to discourage mosquito breeding and reproduction.
- ❖ Dead storage below the outlet to the distribution system and an air gap at the top of the tank should be added to the total volume. For gravity-fed systems, a minimum of 6 inches of dead storage should be provided. For systems using a pump, the dead storage depth will be based on the pump specifications. Any hookup to a municipal backup water supply should have a backflow prevention device to keep municipal water separate from stored rainwater.





Table GIP-11-02. Advantages and Disadvantages of Various Cistern Materials		
Tank Material	Advantages	Disadvantages
<b>Fiberglass</b>	Commercially available, alterable and moveable; durable with little maintenance; light weight; integral fittings (no leaks); broad application	Must be installed on smooth, solid, level footing; pressure proof for below-ground installation; expensive in smaller sizes
<b>Polyethylene</b>	Commercially available, alterable, moveable, affordable; available in wide range of sizes; can install above or below ground; little maintenance; broad application	Can be UV-degradable; must be painted or tinted for above-ground installations; pressure-proof for below-ground installation
<b>Modular Storage</b>	Can modify to topography; can alter footprint and create various shapes to fit site; relatively inexpensive	Longevity may be less than other materials; higher risk of puncturing of water tight membrane during construction
<b>Plastic Barrels</b>	Commercially available; inexpensive	Low storage capacity (20 to 50 gallons); limited application
<b>Galvanized Steel</b>	Commercially available, alterable and moveable; available in a range of sizes; film develops inside to prevent corrosion	Possible external corrosion and rust; must be lined for potable use; can only install above ground; soil pH may limit underground applications
<b>Steel Drums</b>	Commercially available, alterable and moveable	Small storage capacity; prone to corrosion, and rust can lead to leaching of metals; verify prior to reuse for toxics; water pH and soil pH may also limit applications
<b>FerroConcrete</b>	Durable and immovable; suitable for above or below ground installations; neutralizes acid rain	Potential to crack and leak; expensive
<b>Cast in Place Concrete</b>	Durable, immovable, versatile; suitable for above or below ground installations; neutralizes acid rain	Potential to crack and leak; permanent; will need to provide adequate platform and design for placement in clay soils
<b>Stone or Concrete Block</b>	Durable and immovable; keeps water cool in summer months	Difficult to maintain; expensive to build

Source: Cabell Brand (2007, 2009)



The images below in **Figures GIP-11-12 to GIP-11-14** display three examples of various materials and shapes of cisterns discussed in **Table GIP-1-2** above.



**Figure GIP-11-12. Example of Multiple Fiberglass Cisterns in Series**  
(Source: VADCR, 2011)



**Figure GIP-11-13. Example of two Polyethylene Cisterns**  
(Source: VADCR, 2011)





**Figure GIP-11-14. Example of Modular Units  
(Source: VADCR, 2011)**

**Distribution Systems.** Most distribution systems require a pump to convey harvested rainwater from the storage tank to its final destination, whether inside the building, an automated irrigation system, or gradually discharged to a secondary runoff reduction practice. The rainwater harvesting system should be equipped with an appropriately-sized pump that produces sufficient pressure for all end-uses. Separate plumbing labeled as non-potable may be required.

The typical pump and pressure tank arrangement consists of a multi-stage centrifugal pump, which draws water out of the storage tank and sends it into the pressure tank, where it is stored for distribution. When water is drawn out of the pressure tank, the pump activates to supply additional water to the distribution system. The backflow preventer is required to separate harvested rainwater from the main potable water distribution lines.

Distribution lines from the rainwater harvesting system should be buried beneath the frost line. Lines from the rainwater harvesting system to the building should have shut-off valves that are accessible when snow cover is present. A drain plug or cleanout sump, also draining to a pervious area, should be installed to allow the system to be completely emptied, if needed. Above-ground outdoor pipes should be insulated or heat-wrapped to prevent freezing and ensure uninterrupted operation during winter.

**Overflow, Filter Path and Secondary Runoff Reduction Practice.** An overflow mechanism should be included in the rainwater harvesting system design in order to handle an individual storm event or multiple storms in succession that exceed the capacity of the tank. Overflow pipes should have a capacity equal to or greater than the inflow pipe(s) and have a diameter and slope sufficient to drain the cistern while maintaining an adequate freeboard height. The overflow pipe should be screened to prevent access to the tank by rodents and birds.

The filter path is a pervious or grass corridor that extends from the overflow to the next runoff reduction practice, the street, an adequate existing or proposed channel, or the storm drain system. The filter path must be graded with a slope that results in sheet flow conditions. If compacted or impermeable soils are present along the filter





path, compost amendments may be needed (see GIP-09, Appendix A). It is also recommended that the filter path be used for first flush diversions.

In many cases, rainwater harvesting system overflows are directed to a secondary runoff reduction practice to boost overall runoff reduction rates. These options are addressed in GIP-11 Section 5.5.

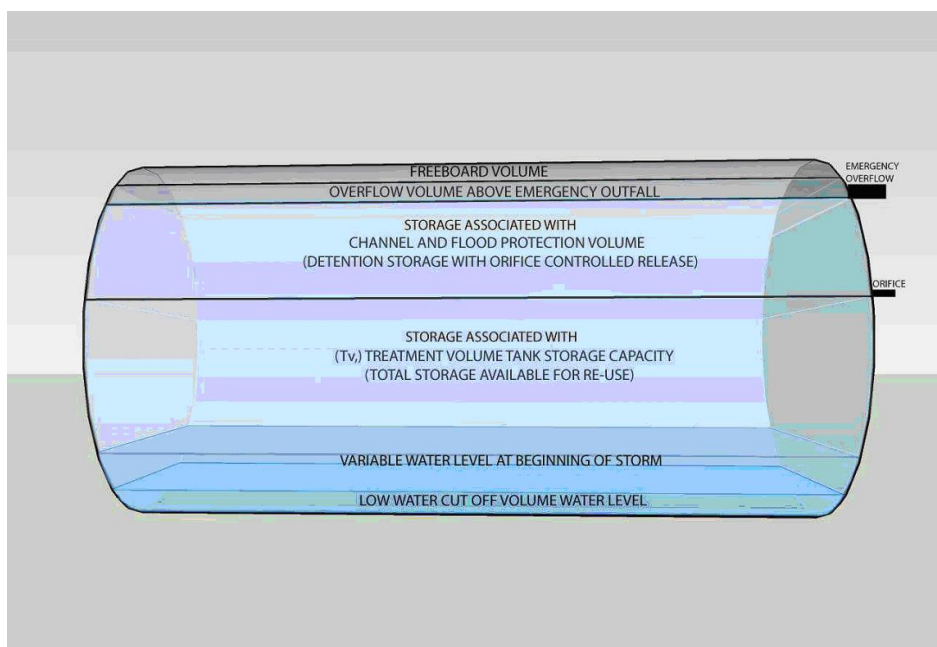
## GIP – 11 SECTION 6: DESIGN CRITERIA

### 6.1 Sizing of Rainwater Harvesting Systems

The rainwater harvesting cistern sizing criteria presented in this section was developed using best estimates of indoor and outdoor water demand, long-term rainfall data, and rooftop capture area data.

### 6.2 Incremental Design Volumes within Cistern

Rainwater tank sizing is determined by accounting for varying precipitation levels, captured rooftop runoff, first flush diversion (through filters) and filter efficiency, low water cut-off volume, dynamic water levels at the beginning of various storms, storage needed for treatment volume (permanent storage), storage needed for channel protection and flood volume (temporary detention storage), seasonal and year-round demand use and objectives, overflow volume, and freeboard volumes above high water levels during very large storms. See Figure GIP-11-15 for a graphical representation of these various incremental design volumes.



**Figure GIP-11-15. Incremental Design Volumes associated with tank sizing**  
(Source: VADCR, 2011)

The “Storage Associated with the Treatment Volume” is the storage within the tank that is modeled and available for reuse. While the Treatment Volume will remain the same for a specific rooftop capture area, the “Storage Associated with the Treatment Volume” may vary depending on demand and runoff reduction credit objectives. It includes the variable water level at the beginning of a storm and the low water cut-off volume that is necessary to satisfy pumping requirements.



### 6.3 Cistern Design Guidance

Go to Metro Water Services website for future guidance and Cistern Design Tools (CDT): [www.nashville.gov/stormwater/LIDManual.asp](http://www.nashville.gov/stormwater/LIDManual.asp)

### 6.4 Rainwater Harvesting Material Specifications

The basic material specifications for rainwater harvesting systems are presented in **Table GIP-11-03**. Designers should consult with experienced rainwater harvesting system and irrigation installers on the choice of recommended manufacturers of prefabricated tanks and other system components.

Table GIP-11-03. Design Specifications for Rainwater harvesting systems	
Item	Specification
Gutters and Downspout	<p>Materials commonly used for gutters and downspouts include PVC pipe, vinyl, aluminum and galvanized steel. Lead should not be used as gutter and downspout solder, since rainwater can dissolve the lead and contaminate the water supply.</p> <ul style="list-style-type: none"> <li>• The length of gutters and downspouts is determined by the size and layout of the catchment and the location of the storage tanks.</li> <li>• Be sure to include needed bends and tees.</li> </ul>
Pre-Treatment	<p>At least one of the following (all rainwater to pass through pre-treatment):</p> <ul style="list-style-type: none"> <li>• First flush diverter</li> <li>• Vortex filter</li> <li>• Roof washer</li> <li>• Leaf and mosquito screen (1 mm mesh size)</li> </ul>
Storage Tanks	<ul style="list-style-type: none"> <li>• Materials used to construct storage tanks should be structurally sound.</li> <li>• Tanks should be constructed in areas of the site where native soils can support the load associated with stored water.</li> <li>• Storage tanks should be water tight and sealed using a water-safe, non-toxic substance.</li> <li>• Tanks should be opaque to prevent the growth of algae.</li> <li>• Re-used tanks should be fit for potable water or food-grade products.</li> <li>• Underground rainwater harvesting systems should have a minimum of 18 to 24 inches of soil cover and be located below the frost line.</li> <li>• The size of the rainwater harvesting system(s) is determined during the design calculations.</li> </ul>

Note: This table does not address indoor systems or pumps.

## GIP – 11 SECTION 7: SPECIAL CASE DESIGN ADAPTATIONS

### 7.1 Steep Terrain

Rainwater harvesting systems can be useful in areas of steep terrain where other stormwater treatments are inappropriate, provided the systems are designed in a way that protects slope stability. Cisterns should be located in level areas where soils have been sufficiently compacted to bear the load of a full storage tank.

Harvested rainwater should not be discharged over steep slopes; rather, the rainwater should be used for indoor non-potable applications or outdoor irrigation.



## GIP – 11 SECTION 8: CONSTRUCTION

### 8.1 Construction Sequence

It is advisable to have a single contractor install the rainwater harvesting system, outdoor irrigation system and secondary runoff reduction practices. The contractor should be familiar with rainwater harvesting system sizing, installation, and placement. A licensed plumber is required to install the rainwater harvesting system components to the plumbing system.

A standard construction sequence for proper rainwater harvesting system installation is provided below. This can be modified to reflect different rainwater harvesting system applications or expected site conditions.

- ❖ Choose the tank location on the site
- ❖ Route all downspouts or roof drains to pre-screening devices and first flush diverters
- ❖ Properly install the tank
- ❖ Install the pump (if needed) and piping to end-uses (indoor, outdoor irrigation, or tank dewatering release)
- ❖ Route all pipes to the tank
- ❖ Stormwater should not be diverted to the rainwater harvesting system until the overflow filter path has been stabilized with vegetation.

### 8.2 Construction Inspection

The following items shall be inspected prior to final sign-off and acceptance of a rainwater harvesting system:

- ❖ Rooftop area matches plans
- ❖ Diversion system is properly sized and installed
- ❖ Pretreatment system is installed
- ❖ Mosquito screens are installed on all openings
- ❖ Overflow device is directed as shown on plans
- ❖ Rainwater harvesting system foundation is constructed as shown on plans
- ❖ Catchment area and overflow area are stabilized
- ❖ Secondary runoff reduction practice(s) is installed as shown on plans

## GIP – 11 SECTION 9: AS-BUILT REQUIREMENTS

After the cistern has been installed, the developer must have an as-built certification of the cistern conducted by a registered professional engineer. The as-built certification verifies that the BMP was installed as designed and approved. The following components are vital components of a properly working cistern and must be addressed in the as-built certification:

**Incorporation of Rainwater Harvesting System into the site Grading and Drainage Plan, as follows:**

1. Include a roof plan of the building that will be used to capture rainwater, showing slope direction and roof material.
2. Include a roof plan of the building that will be used to capture rainwater, showing slope direction and roof material.
3. Display downspout leaders from the rooftops being used to capture rainwater.





4. Display the storm drain pipe layout (pipes between building downspouts and the tank) in plan view, specifying materials, diameters, slopes and lengths, to be included on typical grading and utilities or storm sewer plan sheets.
5. Include a detail or note specifying the minimum size, shape configuration and slope of the gutter(s) that convey rainwater

**Rainwater Harvesting System Construction Document sheet, to show the following:**

1. The Cistern or Storage Unit material and dimensions in a scalable detail (use a cut sheet detail from Manufacturer, if appropriate).
2. Include the specific Filter Performance specification and filter efficiency curves. Runoff estimates from the rooftop area captured for 1-inch storm should be estimated and compared to filter efficiencies for the 1-inch storm. It is assumed that the first flush diversion is included in filter efficiency curves. A minimum of 95% filter efficiency should be met for the Treatment Volume credit. If this value is altered (increased), the value should be reported. Filter curve cut sheets are normally available from the manufacturer. Show the specified materials and diameters of inflow and outflow pipes.
3. Show the inverts of the orifice outlet, the emergency overflows, and, if applicable, the receiving secondary runoff reduction practice or on-site infiltration facility.
4. Include a cross section of the storage unit displaying the inverts associated with the various incremental volumes (if requested by the reviewer).

## **GIP – 11 SECTION 10: MAINTENANCE**

### **10.1 Maintenance Document**

Each BMP must have a Hamilton County Water Quality Stormwater Management Facility I&M Storm Water Management Facilities Agreement submitted for approval and maintained and updated by the BMP owner. The Stormwater Management Facilities I&M Agreement must be completed and submitted to the Program with the Land Disturbance permit application. The Stormwater Management Facilities I&M Agreement is for the use of the BMP owner in performing routine inspections. The developer/owner is responsible for the cost of maintenance and annual inspections. The BMP owner must maintain and update the BMP inspections and maintenance plan.

### **10.2 Maintenance Inspections**

All rainwater harvesting systems components shall be inspected by the property owner twice per year (preferably Spring and the Fall). A comprehensive inspection by a professional engineer or landscape architect shall occur every five years.

### **10.3 Rainwater harvesting system Maintenance Schedule**

Maintenance requirements for rainwater harvesting systems vary according to use. Systems that are used to provide supplemental irrigation water have relatively low maintenance requirements, while systems designed for indoor uses have much higher maintenance requirements. **Table 11.4** describes routine maintenance tasks to keep rainwater harvesting systems in working condition.



Table GIP-11-04. Suggested Maintenance Tasks for Rainwater Harvesting Systems	
Activity	Frequency
Keep gutters and downspouts free of leaves and other debris	O: Twice a year
Inspect and clean pre-screening devices and first flush diverters	O: Four times a year
Inspect and clean storage tank lids, paying special attention to vents and screens on inflow and outflow spigots. Check mosquito screens and patch holes or gaps immediately	O: Once a year
Inspect condition of overflow pipes, overflow filter path and/or secondary runoff reduction practices	O: Once a year
Inspect tank for sediment buildup	I: Every third year
Clear overhanging vegetation and trees over roof surface	I: Every third year
Check integrity of backflow preventer	I: Every third year
Inspect structural integrity of tank, pump, pipe and electrical system	I: Every third year
Replace damaged or defective system components	I: Every third year

Key: O = Owner I = qualified third party inspector

## GIP – 11 SECTION 11: COMMUNITY & ENVIRONMENTAL CONCERNS

Although rainwater harvesting is an ancient practice, it is enjoying a revival due to the inherent quality of rainwater and the many beneficial uses that it can provide (TWDB, 2005). Some common concerns associated with rainwater harvesting that must be addressed during design include:

**Winter Operation.** Rainwater harvesting systems can be used throughout the year if they are located underground or indoors to prevent problems associated with freezing, ice formation and subsequent system damage. Alternately, an outdoor system can be used seasonally or year round if special measures and design considerations are incorporated.

**Plumbing Codes.** Designer and plan reviewers shall consult building codes to determine if they explicitly allow the use of harvested rainwater for toilet and urinal flushing. In the cases where a backup supply is used, rainwater harvesting systems are required to have backflow preventers or air gaps to keep harvested water separate from the main water supply. Pipes and spigots using rainwater must be clearly labeled as non-potable.

**Mosquitoes.** In some situations, poorly designed rainwater harvesting systems can create habitat suitable for mosquito breeding and reproduction. Designers should provide screens on above- and below-ground tanks to prevent mosquitoes and other insects from entering the tanks. If screening is not sufficient in deterring mosquitoes, dunks or pellets containing larvicide can be added to cisterns when water is intended for landscaping use.

**Child Safety.** Above-grade residential rainwater harvesting systems cannot have unsecured openings large enough for children to enter the tank. For underground cisterns, manhole access should be secured to prevent unwanted access.



## SECTION 12: REFERENCES

Cabell Brand Center. 2009. *Virginia Rainwater Harvesting Manual, Version 2.0*. Salem, VA. (Draft Form) <http://www.cabellbrandcenter.org>

Cabell Brand Center. 2007. *Virginia Rainwater Harvesting Manual*. Salem, VA. <http://www.cabellbrandcenter.org>

Center for Watershed Protection (CWP). 2007. *Urban Stormwater Retrofit Practices*. Manual 3 in the Urban Subwatershed Restoration Manual Series. Ellicott City, MD.

City of Franklin, Stormwater Management Program. January 2014. *City of Franklin Stormwater Best Management Practices Manual*.

City of Portland, Environmental Services. 2004. *Portland Stormwater Management Manual*. Portland, OR. <http://www.portlandonline.com/bes/index.cfm?c=dfbcc>

City of Tucson, AZ. 2005. *Water Harvesting Guidance Manual*. City of Tucson, AZ. Tucson, AZ.

Coombes, P. 2004. *Water Sensitive Design in the Sydney Region. Practice Note 4: Rainwater Tanks*. Published by the Water Sensitive Design in the Sydney Region Project. <http://www.wsud.org/planning.htm>

Credit Valley Conservation. 2008. *Credit River Stormwater Management Manual*. Mississauga, Ontario.

Forasté, J. Alex and Hirschman David. 2010. *A Methodology for using Rainwater Harvesting as a Stormwater Management BMP*. ASCE International Low Impact Development Conference, Redefining Water in the City. San Francisco, CA.

Gowland, D. and T. Younos. 2008. *Feasibility of Rainwater Harvesting BMP for Stormwater Management*. Virginia Water Resources Research Center. Special Report SR38-2008. Blacksburg, VA.

National Oceanic and Atmospheric Administration (NOAA). 2004. *NOAA Atlas 14 Precipitation-Frequency Atlas of the United States, Volume 2, Version 3.0*. Revised 2006. Silver Spring, MD.

North Carolina Division of Water Quality. 2008. *Technical Guidance: Stormwater Treatment Credit for Rainwater Harvesting Systems*. Revised September 22, 2008. Raleigh, NC.

Northern Virginia Regional Commission. 2007. *Low Impact Development Supplement to the Northern Virginia BMP Handbook*. Fairfax, Virginia.

Nova Scotia Environment. 2009. *The Drop on Water: Cisterns*. Nova Scotia.

Schueler, T., D. Hirschman, M. Novotny and J. Zielinski. 2007. *Urban stormwater retrofit practices*. Manual 3 in the Urban Subwatershed Restoration Manual Series. Center for Watershed Protection, Ellicott City, MD.

Schueler, T. 2008. Technical Support for the Baywide Runoff Reduction Method. Chesapeake Stormwater Network. Baltimore, MD. [www.chesapeakestormwater.net](http://www.chesapeakestormwater.net)





TWDB. 2005. *The Texas Manual on Rainwater Harvesting*. Texas: Texas Water Development Board.  
[http://www.twdb.state.tx.us/publications/reports/RainwaterHarvestingManual\\_3rdedition.pdf](http://www.twdb.state.tx.us/publications/reports/RainwaterHarvestingManual_3rdedition.pdf) (last accessed on 20 November 2005)

Virginia Department of Conservation and Recreation (VADCR). 2011. Stormwater Design Specification No. 6: Rainwater Harvesting, Version 1.9.5, March 1, 2011.. Available at:  
<http://vwrrc.vt.edu/swc/NonProprietaryBMPs.html>.



## Green Roof



## GIP - 12

### Hamilton County



### Water Quality Program

**Description:** A green roof is a layer of vegetation installed on top of a conventional flat or slightly sloped roof that consists of waterproofing material, root permeable filter fabric, growing media, and specially selected plants.

**Variations:**

- Extensive green roofs have a thin layer of growing medium and are usually composed of sedums.
- Intensive green roofs have a thicker layer of growing medium and contain shrubs, trees and other vegetation.

**Advantages/Benefits:**

- Runoff volume reduction
- Provides flow attenuation
- Extends the life of a conventional roof by up to 20 yrs.
- Provides increased insulation and energy savings
- Reduces air pollution
- Provides habitat for wildlife
- Increases aesthetic value
- Provides sound insulation
- Provides water quality treatment
- Reduces urban heat island effect

**Disadvantages/Limitations:**

- Cost may be greater than a conventional roof, and feasibility is limited by load-bearing capacity of roof
- Must obtain necessary permits and comply with local building codes
- Requires more maintenance than a conventional roof
- Plant survival and waterproofing are potential issues
- May require irrigation

**Selection Criteria:**

**LEVEL 1 – 80% Runoff Reduction Credit**

**LEVEL 2 – 90% Runoff Reduction Credit**

**Land Use Considerations:**

- Residential
- Commercial
- Industrial

**Maintenance:**

- May include watering, fertilizing, and weeding, typically greatest in the first two years when plants are becoming established.
- Maintenance largely depends on the type of green roof system installed and the type of vegetation planted.

**M** **Maintenance Burden**  
L = Low M = Moderate H = High



## GIP – 12 SECTION 1: DESCRIPTION

Vegetated roofs (also known as *green roofs*, *living roofs* or *ecoroofs*) are alternative roof surfaces that typically consist of waterproofing and drainage materials and an engineered growing media that is designed to support plant growth. Vegetated roofs capture and temporarily store stormwater runoff in the growing media before it is conveyed into the storm drain system. A portion of the captured stormwater evaporates or is taken up by plants, which helps reduce runoff volumes, peak runoff rates and pollutant loads on development sites.



There are two different types of vegetated roof systems:

*intensive* vegetated roofs and *extensive* vegetated roofs. Intensive systems have a deeper growing media layer that ranges from 6 inches to 4 feet thick, which is planted with a wider variety of plants, including trees. By contrast, extensive systems typically have much shallower growing media (under 6 inches), which is planted with carefully selected drought tolerant vegetation. Extensive vegetated roofs are much lighter and less expensive than intensive vegetated roofs and are recommended for use on most development and redevelopment sites.

**NOTE: This specification is intended for situations where the primary design objective of the vegetated roof is stormwater management and, unless specified otherwise, addresses extensive roof systems.**

Designers may wish to pursue other design objectives for vegetated roofs, such as energy efficiency, green building or LEED points, architectural considerations, visual amenities and landscaping features, which are often maximized with intensive vegetated roof systems. However, these design objectives are beyond the scope of this specification.

Vegetated roofs typically contain a layered system of roofing, which is designed to support plant growth and retain water for plant uptake while preventing ponding on the roof surface. The roofs are designed so that water drains vertically through the media and then horizontally along a waterproofing layer towards the outlet. Extensive vegetated roofs are designed to have minimal maintenance requirements. Plant species are selected so that the roof does not need supplemental irrigation or fertilization after vegetation is initially established. Tray systems are also available with removable dividers allowing the media to meld together creating a seamless appearance but with less difficulty in construction.

## GIP – 12 SECTION 2: PERFORMANCE

The overall stormwater functions of vegetated roofs are summarized in **Table GIP-12-01**.

Table GIP-12-01: Runoff Volume Reduction Provided by Vegetated Roofs		
Stormwater Function	Level 1 Design	Level 2 Design
Runoff Volume Reduction (RR)	80%	90%





### GIP – 12 SECTION 3: DESIGN TABLE

The major design goal for vegetated roofs is to maximize runoff volume reduction. The rooftops have little TSS loading or loading removal. Designers may choose the baseline design (Level 1) or choose an enhanced (Level 2) design that maximizes nutrient and runoff reduction. In general, most intensive vegetated roof designs will automatically qualify as being Level 2. **Table GIP-12-02** lists the design criteria for Level 1 and 2 designs.

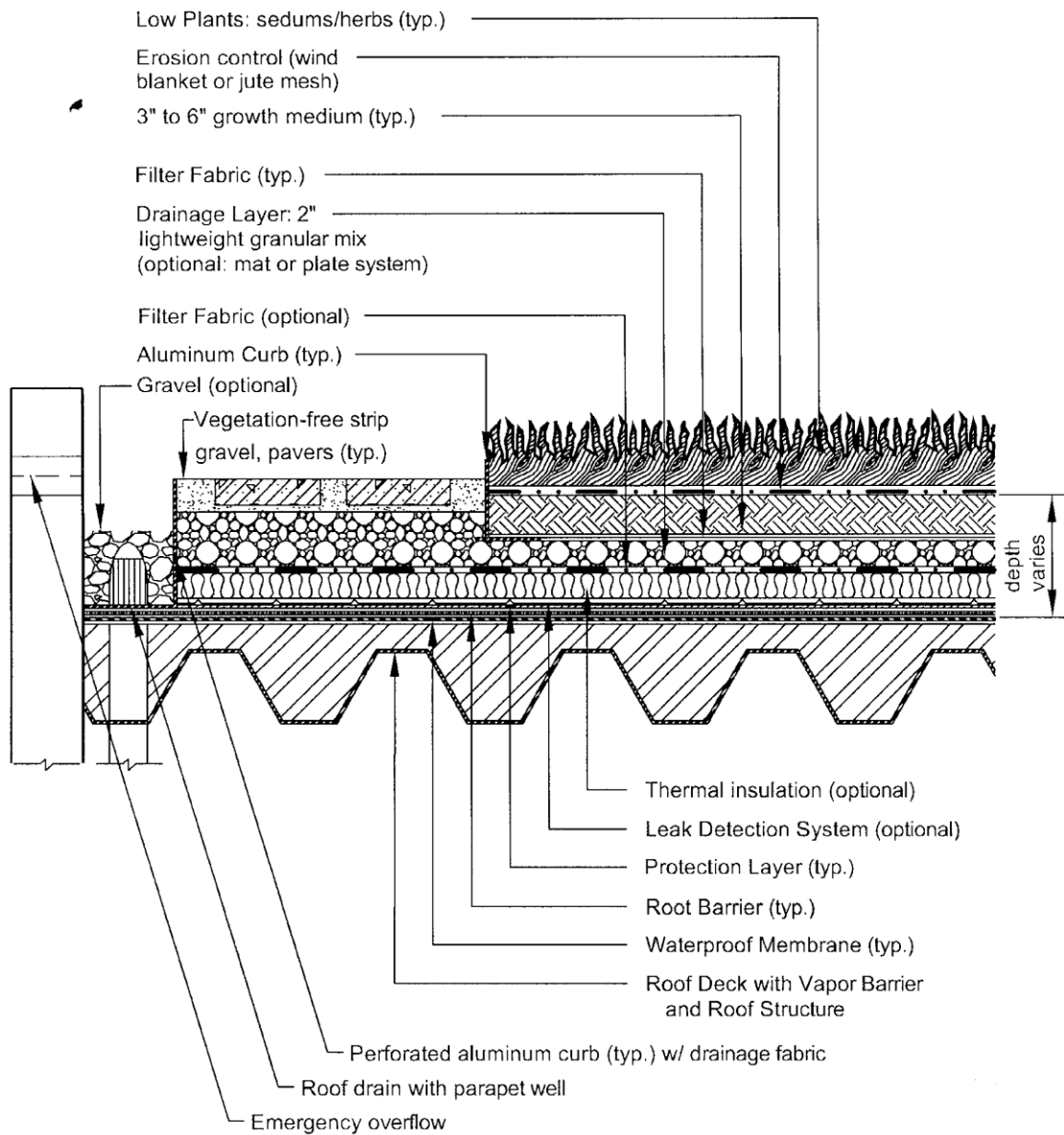
Table GIP-12-02. Green Roof Design Guidance	
Level 1 Design (RR:80)	Level 2 Design (RR: 90)
$T_v = 1.0 (R_v)^1 (A)/12$	$T_v = 1.1 (R_v)^1 (A)/12$
Depth of media up to 6 inches	Media depth > 6 inches
No more than 15% organic matter in media	No more than 15% organic matter in media
<b>All Designs:</b> Must be in conformance to ASTM (2005) International Green (Vegetated) Roof Standards.	

<sup>1</sup>Rv represents the runoff coefficient for a conventional roof, which will usually be 0.95. The runoff reduction rate applied to the vegetated roof is for “capturing” the Treatment Volume (Tv) compared to what a conventional roof would produce as runoff.

### GIP – 12 SECTION 4: TYPICAL DETAILS



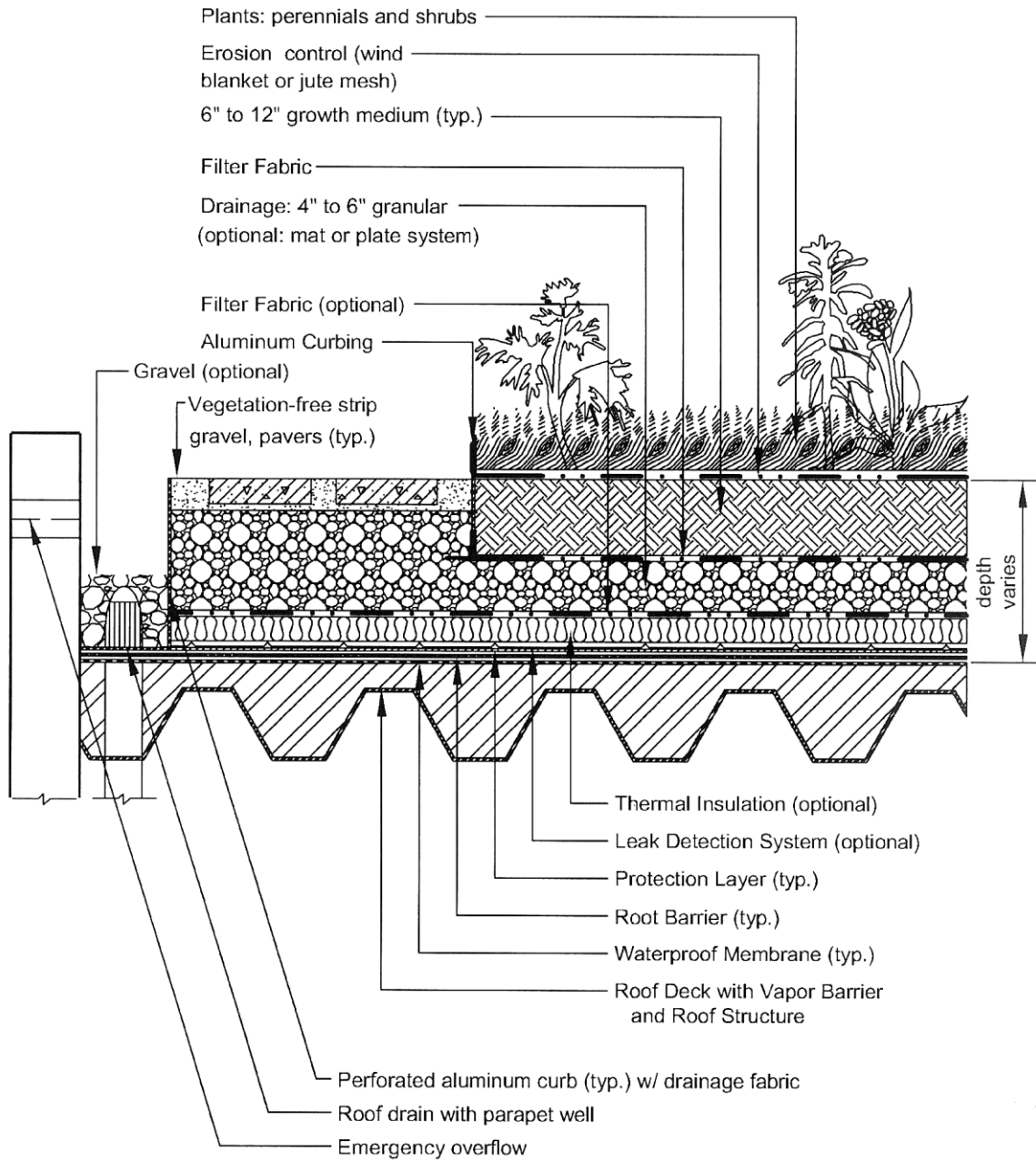
*Figure GIP-12-01. Photos of Vegetated Roof Cross-Sections (source: B. Hunt, NCSU)*



CROSS SECTION VIEW (NTS)

Figure GIP-12-02. Typical Section – Extensive Vegetated Roof  
 (Source: Northern VA Regional Commission)





CROSS SECTION (NTS)

Figure GIP-12-03. Typical Section – Intensive Vegetated Roof  
 (Source: Northern VA Regional Commission)





## GIP – 12 SECTION 5: PHYSICAL FEASIBILITY & DESIGN APPLICATIONS

### 5.1 Typical applications

Vegetated roofs are ideal for use on commercial, institutional, municipal and multi-family residential buildings. They are particularly well suited for use on ultra-urban development and redevelopment sites. Vegetated roofs can be used on a variety of rooftops, including the following:

- ❖ Non-residential buildings (e.g. commercial, industrial, institutional and transportation uses)
- ❖ Multi-family residential buildings (e.g. condominiums or apartments)
- ❖ Mixed-use buildings

### 5.2 Common Site Constraints

**Structural Capacity of the Roof.** When designing a vegetated roof, designers must not only consider the stormwater storage capacity of the vegetated roof, but also its structural capacity to support the weight of the additional water. A conventional rooftop typically must be designed to support an additional 15 to 30 pounds per square foot (psf) for an extensive vegetated roof. As a result, a structural engineer, architect or other qualified professional should be involved with all vegetated roof designs to ensure that the building has enough structural capacity to support a vegetated roof.

**Roof Pitch.** Treatment volume (Tv) is maximized on relatively flat roofs (a pitch of 1 to 2%). Some pitch is needed to promote positive drainage and prevent ponding and/or saturation of the growing media. Vegetated roofs can be installed on rooftops with slopes up to 25% if baffles, grids, or strips are used to prevent slippage of the media. The effective treatment volume (Tv), however, diminishes on rooftops with steep pitches (Van Woert et al, 2005).

**Roof Access.** Adequate access to the roof must be available to deliver construction materials and perform routine maintenance. Roof access can be achieved either by an interior stairway through a penthouse or by an alternating tread device with a roof hatch or trap door not less than 16 square feet in area and with a minimum dimension of 24 inches (NVRC, 2007). Designers should also consider how they will get construction materials up to the roof (e.g., by elevator or crane), and how construction materials will be stockpiled in the confined space.

**Non-Vegetated Areas.** Roof access paths, mechanical equipment, photovoltaic panels, and skylights are counted as part of the green roof for calculation purposes. These areas should not exceed 20% of the roof area counted as green roof.

**Roof Type.** Vegetated roofs can be applied to most roof surfaces, although concrete roof decks are preferred. Certain roof materials, such as exposed treated wood and uncoated galvanized metal, may not be appropriate for vegetated rooftops due to pollutant leaching through the media (Clark et al, 2008).

**Retrofitting Green Roofs.** Key feasibility factors to consider when evaluating a retrofit include the area, age and accessibility of the existing roof, and the capability of the building's owners to maintain it. Options for green roof retrofits are described in Profile Sheet RR-3 of Schueler et al (2007). The structural capacity of the existing rooftop can be a major constraint to a green roof retrofits.

**Building Codes.** The vegetated roof design should comply with the Building Codes with respect to roof drains and emergency overflow devices. If the green roof is designed to be accessible, the access must not only be convenient for installation and maintenance purposes but also must adhere to Building Codes and other regulations for access and safety.



**Construction Cost.** When viewed strictly as stormwater treatment systems, vegetated roofs can cost between \$12 and \$25 per square foot (Moran et al, 2004, Schueler et al 2007). These cost analyses, however, do not include life cycle cost savings relating to increased energy efficiency, higher rents due to green building scores and increased roof longevity. These benefits over the life cycle of a vegetated roof may make it a more attractive investment.

**Risks of Leaky Roofs.** Although well designed and installed green roofs have less problems with roof leaks than traditional roofs, there is a perception among property managers, insurers and product fabricators that this emerging technology could have a greater risk of problems. For an excellent discussion on how to properly manage risk in vegetated roof installations, see Chapter 9 in Weiler and Scholz-Barth (2009).

## GIP – 12 SECTION 6: DESIGN CRITERIA

### 6.1 Overall Sizing

Vegetated roof areas should be sized to capture a portion of the Treatment Volume ( $T_v$ ). The required size of a vegetated roof will depend on several factors, including the porosity and hydraulic conductivity of the growing media and the underlying drainage materials. Site designers and planners should consult with vegetated roof manufacturers and material suppliers for specific sizing guidelines. As a general sizing rule, the following equation can be used to determine the water quality treatment storage volume retained by a vegetated roof:

#### Equation GIP-12-01. Treatment Volume for Green Roof

$$T_v = (RA * D * n)/12$$

Where,

$T_v$  = storage volume (cu. ft.)

RA = vegetated roof area (sq. ft.)

D = media depth (in.)

n = media porosity (usually 0.3, but consult manufacturer specifications)

The resulting  $T_v$  can then be compared to the required  $T_v$  for the entire rooftop area (including all non-vegetated areas) to determine if it meets or exceeds the required  $T_v$  for Level 1 or Level 2 design, as shown in Table 12.2.

### 6.2 Structural Capacity of the Roof

Vegetated roofs can be limited by the additional weight of the fully saturated growing medium and plants, in terms of the physical capacity of the roof to bear structural loads. The designer should consult with a licensed structural engineer or architect to ensure that the building will be able to support the additional live and dead structural load and determine the maximum depth of the vegetated roof system and any needed structural reinforcement.

In most cases, fully-saturated extensive vegetated roofs have a maximum load of about 30 lbs./sq. ft., which is fairly similar to traditional new rooftops (12 to 15 lbs./sq. ft.) that have a waterproofing layer anchored with stone ballast. For an excellent discussion of vegetated roof structural design issues, consult Chapter 9 in Weiler and Scholz-Barth (2009) and ASTM E2397, Standard Practice for Determination of Dead Loads and Live Loads Associated with Green (Vegetated) Roof Systems.

### 6.3 Functional Elements of a Vegetated Roof System

A vegetated roof is composed of up to eight different systems or layers, from bottom to top, that are combined together to protect the roof and maintain a vigorous cover. Designers can employ a wide range of materials for



each layer, which can differ in cost, performance, and structural load. The entire system as a whole must be assessed to meet design requirements. Some manufacturers offer proprietary vegetated roofing systems, whereas in other cases, the designer or architect must assemble their own system, in which case they are advised to consult Weiler and Scholz-Barth (2009), Snodgrass and Snodgrass (2006) and Dunnett and Kingsbury (2004).

- 1. Deck Layer.** The roof deck layer is the foundation of a vegetated roof. It and may be composed of concrete, wood, metal, plastic, gypsum or a composite material. The type of deck material determines the strength, load bearing capacity, longevity and potential need for insulation in the vegetated roof system. In general, concrete decks are preferred for vegetated roofs, although other materials can be used as long as the appropriate system components are matched to them.
- 2. Waterproofing Layer.** All vegetated roof systems must include an effective and reliable waterproofing layer to prevent water damage through the deck layer. A wide range of waterproofing materials can be used, including built up roofs, modified bitumen, single-ply, and liquid-applied methods (see Weiler and Scholz-Barth, 2009 and Snodgrass and Snodgrass, 2006). The waterproofing layer must be 100% waterproof and have an expected life span as long as any other element of the vegetated roof system.
- 3. Insulation Layer.** Many vegetated rooftops contain an insulation layer, usually located above, but sometimes below, the waterproofing layer. The insulation increases the energy efficiency of the building and/or protects the roof deck (particularly for metal roofs). According to Snodgrass and Snodgrass (2006), the trend is to install insulation on the outside of the building, in part to avoid mildew problems.
- 4. Root Barrier (Optional).** The next layer of a vegetated roof system is an optional root barrier that protects the waterproofing membrane from root penetration. A wide range of root barrier options are described in Weiler and Scholz-Barth (2009). Chemical root barriers or physical root barriers that have been impregnated with pesticides, metals or other chemicals that could leach into stormwater runoff should be avoided.
- 5. Drainage Layer and Drainage System.** A drainage layer is then placed between the optional root barrier and the growing media to quickly remove excess water from the vegetation root zone. The drainage layer should consist of synthetic or inorganic materials (e.g. gravel, recycled polyethylene, etc.) that are capable of retaining water and providing efficient drainage. A wide range of prefabricated water cups or plastic modules can be used, as well as a traditional system of protected roof drains, conductors and roof leader. The required depth of the drainage layer is governed by both the required stormwater storage capacity and the structural capacity of the rooftop. ASTM E2396 and E2398 can be used to evaluate alternative material specifications.
- 6. Root-Permeable Filter Fabric.** A semi-permeable polypropylene filter fabric is normally placed between the drainage layer and the growing media to prevent the media from migrating into the drainage layer and clogging it.
- 7. Growing Media.** The next layer in an extensive vegetated roof is the growing media, which is typically 4 to 6 inches deep for extensive roofs and 6 inches or more for intensive roofs. The depth and composition of the media is described in Section 6.5.
- 8. Plant Cover.** The top layer of a vegetated roof typically consists of slow-growing, shallow-rooted, perennial, succulent plants that can withstand harsh conditions at the roof surface. An experienced design professional





should be consulted to select the plant species best suited to a given installation. Guidance on selecting the appropriate vegetated roof plants for hardiness zones in Nashville can be found in Snodgrass and Snodgrass (2006). A mix of base ground covers (usually Sedum species) and accent plants can be used to enhance the visual amenity value of a green roof.

#### 6.4 Pretreatment

Pretreatment is not needed for green roofs.

#### 6.5 Filter Media Composition

The recommended growing media for extensive vegetated roofs is composed of approximately 80% to 90% lightweight inorganic materials, such as expanded slates, shales or clays, pumice, scoria or other similar materials. The remaining media should contain no more than 15% organic matter, normally well-aged compost. The percentage of organic matter should be limited, since it can leach nutrients into the runoff from the roof and clog the permeable filter fabric. The growing media should have a maximum water retention capacity of around 30%. It is advisable to mix the media in a batch facility prior to delivery to the roof. More information on growing media can be found in Weiler and Scholz-Barth (2009) and Snodgrass and Snodgrass (2006).

The composition of growing media for intensive vegetated roofs may be different, and it is often much greater in depth (e.g., 6 inches to 4 feet). If trees are included in the vegetated roof planting plan, the growing media must provide enough volume for the root structure of mature trees.

#### 6.6 Conveyance and Overflow

The drainage layer below the growth media should be designed to convey the 10-year storm without backing water up to into the growing media. The drainage layer should convey flow to an outlet or overflow system such as a traditional rooftop drainage system with inlets set slightly above the elevation of the vegetated roof surface. Roof drains immediately adjacent to the growing media should be boxed and protected by flashing extending at least 3 inches above the growing media to prevent clogging.

#### 6.7 Vegetation and Surface Cover

A planting plan must be prepared for a vegetated roof by a landscape architect, botanist or other professional experienced with vegetated roofs, and it must be reviewed and approved by the Program.

Plant selection for vegetated rooftops is an integral design consideration, which is governed by local climate and design objectives. The primary ground cover for most vegetated roof installations is a hardy, low-growing succulent, such as Sedum, Delosperma, Talinum, Semperivum or Hieracium that is matched to the local climate conditions and can tolerate the difficult growing conditions found on building rooftops (Snodgrass and Snodgrass, 2006). Nashville lies in the transition zone between USDA Plant Hardiness Zones 6 and 7 (AHS, 2003).

Other vegetation considerations:

- ❖ Plant choices can be much more diverse for deeper intensive vegetated roof systems. Herbs, forbs, grasses, shrubs and even trees can be used, but designers should understand they have higher watering, weeding and landscape maintenance requirements.
- ❖ The species and layout of the planting plan should reflect the location of building, in terms of its height, exposure to wind, snow loading, heat stress, orientation to the sun, and shading by surrounding buildings. In addition, plants should be selected that are fire resistant and able to withstand heat, cold and high winds.



- ❖ Designers should also match species to the expected rooting depth of the growing media, which can also provide enough lateral growth to stabilize the growing media surface. The planting plan should usually include several accent plants to provide diversity and seasonal color. For a comprehensive resource on vegetated roof plant selection, consult Snodgrass and Snodgrass (2006).
- ❖ It is also important to note that most vegetated roof plant species will not be native to the Southeast (which is in contrast to native plant recommendations for other stormwater practices, such as bioretention and constructed wetlands).
- ❖ Given the limited number of vegetated roof plant nurseries in the region, designers should order plants 6 to 12 months prior to the expected planting date. It is also advisable to have plant materials contract-grown.
- ❖ When appropriate species are selected, most vegetated roofs will not require supplemental irrigation, except during the first year that the vegetated roof is being established or during periods of drought. Irrigation should thus be provided as needed for full establishment and during drought periods. The planting window extends from the spring to early fall, although it is important to allow plants to root thoroughly before the first killing frost.
- ❖ Plants can be established using cuttings, plugs, mats, and, more rarely, seeding or containers. Several vendors also sell mats, rolls, or proprietary vegetated roof planting modules. For the pros and cons of each method, see Snodgrass and Snodgrass (2006).
- ❖ The goal for vegetated roof systems designed for stormwater management is to establish a full and vigorous cover of low-maintenance vegetation that is self-sustaining and requires minimal mowing, trimming or weeding.
- ❖ The vegetated roof design should include non-vegetated walkways (e.g., permeable paver blocks) to allow for easy access to the roof for weeding and making spot repairs.

### 6.8 Material Specifications

Standards specifications for North American vegetated roofs continue to evolve, and no universal material specifications exist that cover the wide range of roof types and system components currently available. The American Society for Testing and Materials (ASTM) has recently issued several overarching vegetated roof standards, which are described and referenced in Table 12.3.

Designers and reviewers should also fully understand manufacturer specifications for each system component listed in Section 6.3, particularly if they choose to install proprietary “complete” vegetated roof systems or modules.



Table GIP-12-03. Extensive Vegetated Roof Material Specifications	
Material	Specification
Roof	Structural Capacity should conform to ASTM E2397-05, <i>Practice for Determination of Live Loads and Dead Loads Associated with Green (Vegetated) Roof Systems</i> . In addition, use standard test methods ASTM E2398-05 for <i>Water Capture and Media Retention of Geocomposite Drain Layers for Green (Vegetated) Roof Systems</i> , and ASTM E2399-05 for <i>Maximum Media Density for Dead Load Analysis</i> .
Waterproof Membrane	See Chapter 6 of Weiler and Scholz-Barth (2009) for waterproofing options that are designed to convey water horizontally across the roof surface to drains or gutter. This layer may sometimes act as a root barrier.
Root Barrier(Optional)	Impermeable liner that impedes root penetration of the membrane.
Drainage Layer	1 to 2 inch layer of clean, washed granular material, such as ASTM D 448 size No. 8 stone. Roof drains and emergency overflow should be designed in accordance with County/City Codes.
Filter Fabric	Needled, non-woven, polypropylene geotextile. Density (ASTM D3776) > 16 oz./sq. yd., or approved equivalent. Puncture resistance (ASTM D4833) > 220 lbs., or approved equivalent.
Growth Media	85% lightweight inorganic materials and 15% organic matter (e.g. well-aged compost). Media should have a maximum water retention capacity of around 30%. Media should provide sufficient nutrients and water holding capacity to support the proposed plant materials. Determine acceptable saturated water permeability using ASTM E2396-05.
Plant Materials	Low plants such as sedum, herbaceous plants, and perennial grasses that are shallow-rooted, self-sustaining, and tolerant of direct sunlight, drought, wind, and frost. See ASTM E2400-06, <i>Guide for Selection, Installation and Maintenance of Plants for Green (Vegetated) Roof Systems</i> .

## GIP – 12 SECTION 7: CONSTRUCTION

### 7.1 Construction Sequence

Given the diversity of extensive vegetated roof designs, there is no typical step-by-step construction sequence for proper installation. The following general construction considerations are noted:

- ❖ Construct the roof deck with the appropriate slope and material.
- ❖ Install the waterproofing method, according to manufacturer’s specifications.
- ❖ Conduct a flood test to ensure the system is water tight by placing at least 2 inches of water over the membrane for 48 hours to confirm the integrity of the waterproofing system.
- ❖ Add additional system components (e.g., insulation, optional root barrier, drainage layer and interior drainage system, and filter fabric), taking care not to damage the waterproofing. Drain collars and protective flashing should be installed to ensure free flow of excess stormwater.
- ❖ The growing media should be mixed prior to delivery to the site. Media should be spread evenly over the filter fabric surface. The growing media should be covered until planting to prevent weeds from growing. Sheets of exterior grade plywood can also be laid over the growing media to accommodate foot or wheelbarrow traffic. Foot traffic and equipment traffic should be limited over the growing media to reduce compaction.





- ❖ The growing media should be moistened prior to planting, and then planted with the ground cover and other plant materials, per the planting plan, or in accordance with ASTM E2400. Plants should be watered immediately after installation and routinely during establishment.
- ❖ It generally takes 12 to 18 months to fully establish the vegetated roof. An initial fertilization using slow release fertilizer (e.g., 14-14-14) with adequate minerals is often needed to support growth. Watering is needed during the first summer. Hand weeding is also critical in the first two years (see Table 10.1 of Weiler and Scholz-Barth, 2009, for a photo guide of common rooftop weeds).
- ❖ Most construction contracts should contain a Care and Replacement Warranty that specifies a 75% minimum survival after the first growing season of species planted and a minimum effective vegetative ground cover of 75% for flat roofs and 90% for pitched roofs.

## 7.2 Construction Inspection

Inspections during construction are needed to ensure that the vegetated roof is built in accordance with these specifications. Detailed inspection checklists should be used that include sign-offs by qualified individuals at critical stages of construction and confirm that the contractor's interpretation of the plan is consistent with the intent of the designer and/or manufacturer.

An experienced installer should be retained to construct the vegetated roof system. The vegetated roof should be constructed in sections for easier inspection and maintenance access to the membrane and roof drains. Careful construction supervision is needed during several steps of vegetated roof installation, as follows:

- ❖ During placement of the waterproofing layer, to ensure that it is properly installed and watertight;
- ❖ During placement of the drainage layer and drainage system;
- ❖ During placement of the growing media, to confirm that it meets the specifications and is applied to the correct depth;
- ❖ Upon installation of plants, to ensure they conform to the planting plan;
- ❖ Before issuing use and occupancy approvals.

## GIP – 12 SECTION 8: AS-BUILT REQUIREMENTS

After the green roof has been constructed, the developer must have an as-built certification of the green roof conducted by a registered professional engineer. The as-built certification verifies that the BMP was installed as designed and approved. The following components are vital components of a properly working green roof and must be addressed in the as-built certification:

1. Protection of vulnerable areas (abutting vertical walls, roof vent pipes, outlets, air conditioning units and perimeter areas) from leakage;
2. Profile view of facility including typical cross-sections with dimensions;
3. Growing medium specification including dry and saturated weight;
4. Filter fabric specification;
5. Drainage layer specification;
6. Waterproof membrane specification, including root barriers;
7. Stormwater piping associated with the site, including pipe materials, sizes, slopes, invert elevations at bends and connections; and
8. Planting and irrigation plan.



## GIP – 12 SECTION 9: MAINTENANCE

### 9.1 Maintenance Inspections and Ongoing Operations

Each BMP must have a Hamilton County Water Quality Stormwater Management Facility I&M Storm Water Management Facilities Agreement submitted for approval and maintained and updated by the BMP owner. The Stormwater Management Facilities I&M Agreement must be completed and submitted to the Program with the Land Disturbance permit application. The Stormwater Management Facilities I&M Agreement is for the use of the BMP owner in performing routine inspections. The developer/owner is responsible for the cost of maintenance and annual inspections. The BMP owner must maintain and update the BMP inspections and maintenance plan.

A vegetated roof should be inspected twice a year during the growing season to assess vegetative cover, and to look for leaks, drainage problems and any rooftop structural concerns (see **Table GIP-12-04**). In addition, the vegetated roof should be hand-weeded to remove invasive or volunteer plants, and plants/media should be added to repair bare areas (refer to ASTM E2400). Many practitioners also recommend an annual application of slow release fertilizer in the first few years after the vegetated roof is installed.

If a roof leak is suspected, it is advisable to perform an electric leak survey (i.e., Electrical Field Vector Mapping) to pinpoint the exact location, make localized repairs, and then reestablish system components and ground cover.

The use of herbicides, insecticides, and fungicides should be avoided, since their presence could hasten degradation of the waterproof membrane. Also, power-washing and other exterior maintenance operations should be avoided so that cleaning agents and other chemicals do not harm the vegetated roof plant communities.

**Table GIP-12-04. Typical Maintenance Activities Associated with Green Roofs**

Activity	Schedule
Water to promote plant growth and survival.	As needed
Inspect the vegetated roof and replace any dead or dying vegetation.	Following Construction
Inspect the waterproof membrane for leaking or cracks.	Semi-annually
Annual fertilization.	As needed
Weeding to remove invasive plants.	As needed
Inspect roof drains, scuppers and gutters to ensure they are not overgrown or have organic matter deposits. Remove any accumulated organic matter or debris.	Semi-annually
Inspect the green roof for dead, dying or invasive vegetation. Plant replacement vegetation as needed.	As needed



## GIP – 12 SECTION 10: REFERENCES

- American Horticultural Society (AHS). 2003. *United States Department of Agriculture Plant Hardiness Zone Map*. Alexandria, VA.
- ASTM International. 2005. *Standard Test Method for Maximum Media Density for Dead Load Analysis of Green (Vegetated) Roof Systems*. Standard E2399-05. ASTM, International. West Conshohocken, PA. available online: <http://www.astm.org/Standards/E2399.htm>.
- ASTM International. 2005. *Standard Test Method for Saturated Water Permeability of Granular Drainage Media [Falling-Head Method] for Green (Vegetated) Roof Systems*. Standard E2396- 05. ASTM, International. West Conshohocken, PA. available online: <http://www.astm.org/Standards/E2396.htm>.
- ASTM International. 2005. *Standard Test Method for Water Capture and Media Retention of Geocomposite Drain Layers for Green (Vegetated) Roof Systems*. Standard E2398-05. ASTM, International. West Conshohocken, PA. available online: <http://www.astm.org/Standards/E2398.htm>.
- ASTM International. 2005. *Standard Practice for Determination of Dead Loads and Live Loads Associated with Green (Vegetated) Roof Systems*. Standard E2397-05. ASTM, International. West Conshohocken, PA. available online: <http://www.astm.org/Standards/E2397.htm>.
- ASTM International. 2006. *Standard Guide for Selection, Installation and Maintenance of Plants for Green (Vegetated) Roof Systems*. Standard E2400-06. ASTM, International. West Conshohocken, PA. available online: <http://www.astm.org/Standards/E2400.htm>.
- Berhage, R., A. Jarrett, D. Beattie and others. 2007. *Quantifying evaporation and transpiration water losses from green roofs and green roof media capacity for neutralizing acid rain*. Final Report. National Decentralized Water Resource Capacity Development Project Research Project. Pennsylvania State University.
- City of Franklin, Stormwater Management Program. January 2014. *City of Franklin Stormwater Best Management Practices Manual*.
- Clark, S., B. Long, C. Siu, J. Spicher and K. Steele. 2008. "Early-life runoff quality: green versus traditional roofs." *Low Impact Development 2008*. Seattle, WA. American Society of Civil Engineers.
- Dunnett, N. and N. Kingsbury. 2004. *Planting Green Roofs and Living Walls*. Timber Press. Portland, Oregon.
- Maryland Department of Environment. (MDE). 2008. *Chapter 5. Environmental Site Design. "Green Roofs."* Baltimore, MD.
- Miller, C. 2008. *Green roofs as stormwater best management practices: Preliminary computation of runoff coefficients: sample analysis in the Mid-Atlantic states*. Roofscapes, Inc. Philadelphia, PA.
- Moran, A., W. Hunt and G. Jennings. 2004. *Green roof research of stormwater runoff quantity and quality in North Carolina*. NWQEP Notes. No. 114. North Carolina State University. Raleigh, NC.





- North Carolina State University (NCSU). 2008. *Green Roof Research Web Page*. Department of Biological and Agricultural Engineering. <http://www.bae.ncsu.edu/greenroofs> .
- Northern Virginia Regional Commission (NVRC). 2007. *Low Impact Development Manual*. “Vegetated Roofs.” Fairfax, VA.
- Schueler et al 2007. *Urban Stormwater Retrofit Practices*. Manual 3 in the Urban Subwatershed Restoration Manual Series. Center for Watershed Protection. Ellicott City, MD.
- Snodgrass, E. and L. Snodgrass. 2006. *Green Roof Plants: a resource and planting guide*. Timber Press. Portland, OR.
- Van Woert, N., D. Rowe, A. Andersen, C. Rugh, T. Fernandez and L. Xiao. 2005. “Green roof stormwater retention: effects of roof surface, slope, and media depth.” *Journal of Environmental Quality*. 34: 1036-1044.
- VADCR. 2011. Stormwater Design Specification No. 5: Vegetated Roof, Version 2.3, March 1, 2011. Virginia Department of Conservation and Recreation. <http://vwrrc.vt.edu/swc/NonProprietaryBMPs.html>.
- Weiler, S. and K. Scholz-Barth 2009. *Green Roof Systems: A Guide to the Planning, Design, and Construction of Landscapes over Structure*. Wiley Press. New York, NY.



## Stormwater Wet Pond



## TSS - 01

### Hamilton County



### Water Quality Program

**Description:** Constructed stormwater detention basin that has a permanent pool (or micropool). Runoff from each rain event is captured and treated in the pool primarily through settling and biological uptake mechanisms.  
**Variations:** Wet extended detention, micropool extended detention, multiple pond system.

#### Components:

- Permanent pool – prevents resuspension of solids
- Live storage above permanent pool – sized for a percentage of water quality volume and flow attenuation. Percentage depends on type of wet pond chosen
- Forebay – settles out larger sediments in an area where sediment removal will be easier
- Spillway system – spillway system(s) provides outlet for stormwater runoff when large storm events occur and maintains the permanent pool

#### Advantages/Benefits:

- Moderate to high pollutant removal
- Can be designed as a multi-functional BMP
- Cost effective
- Can be designed as an amenity within a development
- Wildlife habitat potential
- High community acceptance when integrated into a development

#### Disadvantages/Limitations:

- Potential for thermal impacts downstream
- May require additional permitting through TDEC for ARAP or Safe Dams
- Community perceived concerns with mosquitoes and safety

#### Design considerations:

Continued on next page....

#### Selection Criteria:

- Water Quality**  
80 % TSS Removal
- Quantity Control**

#### Land Use Considerations:

- Residential**
- Commercial**
- Industrial**

#### Maintenance:

- Remove debris from inlet and outlet structures
- Maintain side slopes/remove invasive vegetation
- Monitor sediment accumulation and remove periodically

#### Maintenance Burden

**M**

L = Low M = Moderate H = High



## TSS – 01 SECTION 1: DESCRIPTION

### Design considerations:

- Minimum contributing drainage area of 25 acres; 10 acres for micropool extended detention (Unless water balance calculations show support of permanent pool by a smaller drainage area)
- Sediment forebay or equivalent pretreatment must be provided
- Minimum length to width ratio = 3:1
- Maximum depth of permanent pool = 8'
- 3:1 side slopes or flatter around pond perimeter

Stormwater ponds are constructed stormwater basins that can be designed to serve multiple functions, including stormwater quality treatment, peak flow attenuation, and wildlife habitat creation. Stormwater quality treatment is achieved in the storage provided both within the permanent pool and the live pool volume, depending on the type of wet pond design. The permanent pool (or micropool for micropool extended detention design) provides the majority of the volume used for settling particulates. A well-designed and landscaped pond can be an aesthetic

feature when planned and located properly.

Figure 1.1 illustrates a typical wet pond, showing the components found in the pond variations, described in the next section. Figures 1.2, 1.3, and 1.4 are schematics for wet pond variations that are allowed by the Program.

Stormwater wet ponds must be designed by a licensed professional engineer.

## TSS – 01 SECTION 2: COMPONENTS

**Sediment forebay.** The forebay is a pretreatment BMP that allows heavier sediments to settle out before they reach the permanent pool. Often, the floor of the forebay is concrete or other hardened surface so that periodic sediment removal is easier. The forebay treatment area can provide for a portion of the required water quality treatment volume for a site.

**Permanent pool.** The permanent pool, or dead storage, provides the mechanism for settling out solids from stormwater runoff, as well as providing the setting for biological uptake of some pollutants. As new stormwater runoff enters the permanent pool, stormwater stored in the permanent pool is replaced. A micropool is a type of permanent pool

**Live storage.** The storage area provided above the permanent pool is used to capture and slowly release the first flush volume. In some pond variations, such as the wet extended detention pond, the water quality treatment volume is split between the permanent pool and the live storage area. Larger storm events can also be treated for peak flow attenuation within the live storage volume.

**Spillway systems.** Spillway systems are typically made up of emergency spillways and primary spillway systems, designed as channels, riser and barrel structures, or a combination of the two. Spillway systems for wet ponds typically have multiple outlets to control different design storms. The spillway system must also include an emergency drain to allow complete draining of the pond within 24 hours.





## TSS – 01 SECTION 3: DESIGN VARIATIONS

The following design variations are allowed as stormwater quality treatment BMPs in the Program area:

**Wet pond.** Stormwater wet ponds are built with a permanent pool, or dead storage, equal to the water quality volume. Stormwater runoff displaces the water already in the pool. Temporary storage is provided above the permanent pool elevation for attenuation of larger storm events.

**Wet extended detention (ED) pond.** In a wet extended detention (ED) pond, the water quality volume is split evenly between the permanent pool and extended detention (ED) storage provided above the permanent pool. During storm events, water is detained above the permanent pool elevation for 24-48 hours. This design provides the same pollutant reduction but consumes less space.

**Micropool extended detention pond.** Variation of the ED pond, where a micropool is maintained below the outlet of the pond. The micropool volume is calculated as 0.1 inch per impervious acre or 20% of the water quality volume ( $WQ_v$ ), whichever is greater. The remainder of the required water quality volume is stored above the micropool in the live pool storage. The micropool prevents resuspension of solids and prevents clogging of low flow orifices. The live pool storage above the micropool is also used for the attenuation of larger storm events. The water quality volume stored in the live pool area must be detained for 24 hours. This pond most resembles the “dry pond” design. The difference in this style pond and the wet ED pond is the storage location of the water quality volume ( $WQ_v$ ).

**Multiple pond systems.** Multiple ponds in series, that provide longer flow paths and two or more storage cells for water quality and quantity treatment. Pollutant reduction of ponds in series provides more than 80% TSS removal (see Section 2.2.2 for guidance on pollutant removal reductions for BMPs in series).

## TSS – 01 SECTION 4: SITE AND DESIGN CONSIDERATIONS

The following design and site considerations must be incorporated into the BMP plan:

### General Design

1. A licensed professional engineer must design all types of wet ponds.
2. Ponds must not be constructed in or located on a stream.
3. All components of a stormwater wet pond, including access, must be located in a drainage easement.
4. Access to the forebay, permanent pool and spillways must be considered in the planning and design. Permanent access must be provided from a public road and maintained throughout the life of the structure.
5. A minimum drainage area of 25 acres is needed for wet ponds and wet ED ponds to maintain the permanent pool. The minimum drainage area for micropool ED ponds is 10 acres. A smaller drainage area may be acceptable with an adequate water balance (refer to TSS-02 *Constructed Wetlands Design Procedures Step #2* for water balance calculations) and an anti-clogging pond outlet.
6. The space required to construct a wet pond is approximately 2-3% of the tributary drainage area.
7. Stormwater ponds should be located to provide for maximum runoff storage at a minimal construction cost.
8. Stormwater ponds should not be located on slopes that are equal to or greater than 15%.



### Pretreatment

9. All stormwater ponds must incorporate a sediment forebay or pretreatment device at the point or points of inflow. The purpose of the pretreatment is to settle out heavier solids in an area that is easier to clean out than the permanent pool.
10. The forebay must consist of a separate cell from the permanent pool, separated by an acceptable barrier.
  - a. For maintenance purposes in larger ponds, the bottom of the forebay should be hardened (e.g., concrete lined) to make sediment removal easier and width of the forebay should accommodate a small piece of equipment, such as a Bobcat.
  - b. The forebay must be sized to contain 0.1 inches per impervious acre contributing drainage and should be a minimum of 4-6 feet deep and at least 9 feet wide. It is generally 10 percent the volume of the permanent pool. The forebay storage volume counts toward the total WQv requirement and may be subtracted from the WQv for subsequent calculations.
  - c. A fixed vertical sediment depth marker must be installed in the forebay to visually indicate sediment depth over time.
  - d. Exit velocities from the forebay must be non-erosive.
11. Although forebays are preferred for pretreatment because they require less maintenance, other acceptable pretreatment devices include baffle boxes or stormwater quality inlets.

### Permanent Pool

12. The maximum depth of the permanent pool is 8 feet (typical depth is 3 to 6 feet). The objective is to avoid thermal stratification that could result in odor problems associated with anaerobic conditions.
13. In general, stormwater pond designs will be unique for each site. However, the following should be observed to meet the pollutant removal goals:
  - a. Permanent pool:
    - i. Standard wet ponds: 100% of the water quality treatment volume (1.0 WQv).
    - ii. Wet ED pond: 50% of the water quality treatment volume (0.5 WQv), the other 50% is accounted for in the live pool volume.
    - iii. Micropool pond: Approximately 0.1 inch per impervious acre or 20% of the water quality treatment volume (0.1 IA) or (0.2 WQv), whichever is greater.

Short-circuiting of the pond should be avoided by designing stormwater ponds with a length to width ratio of 3:1 or greater. Baffles, pond shaping, or islands can be added to the permanent pool area to create a longer flow path.

- b. Side slopes of the pond should not exceed 3H:1V, or additional safety precautions must be provided, and should terminate on a safety bench (see Figure 1.5). The safety bench requirement may be waived if the side slopes are 4H:1V or flatter.
14. Bedrock must be considered in the Program area because excavation may be required for a permanent pool. If there is highly fractured bedrock or karst topography, then the feasibility of a wet pond should be carefully considered because it may not hold water and the additional water flow and/or weight could intensify karst activity.
15. To maintain a permanent pool, excessive losses through infiltration must be avoided. Depending on the soils, infiltration losses can be minimized through compaction, the addition of a clay liner or an artificial liner.

### Live Pool

16. Live pool volumes are dependent upon the need for storm attenuation. Hydrograph routing must be completed for the 2- through 100-year events to determine the required volume and to demonstrate that post-construction flow rates are equal to or smaller than pre-construction rates for each event. Wet ED



ponds and micropool ED ponds require that a percentage of the WQv be treated in the live-pool volume. This volume can also be included as volume required for storm attenuation.

### Outlet Structures

17. Flow control from a stormwater pond is typically accomplished with the use of a concrete or corrugated metal riser and barrel. The riser should be located within the stormwater pond embankment for maintenance access, safety, floatation prevention, and aesthetics. See Figures 1.6 through 1.8 for typical pond outlet structures.
18. To control different storm events, outlets at varying elevations on the riser pipe should be used. The number of orifices varies and is usually a function of the pond design parameters. For example, a wet pond riser configuration is typically comprised of multiple small storm outlets (usually orifices) and the 25- and 100- year outlets (often slots or weirs).

Water quality outlet designs require additional outlet configurations, separate from the storm attenuation/flood control outlet. For wet ponds, the water quality volume is fully contained in the permanent pool, no additional orifice sizing is necessary for this volume. For larger volumes, orifice sizing guidance is included in the Design Procedures and Figures 1.8 and 1.9. As runoff from a water quality event enters the wet pond, it simply displaces that same volume through a smaller storm event orifice. Thus an off-line wet pond providing only water quality treatment can use a simple overflow weir as the outlet structure. On-line wet ponds may or may not require multi-stage riser configurations, depending on the need for storm attenuation. In the case of wet ED ponds and micropool ED ponds, there is an additional outlet (usually an orifice) that is sized to pass the extended detention water quality volume on top of the permanent pool. Flow will first pass through this orifice, which is sized to release the water quality ED volume in 24-48 hours. The preferred design is a reverse slope pipe attached to the riser, with its inlet submerged 1 foot below the elevation of the permanent pool to prevent floatables from clogging the pipe and to avoid discharging warmer water at the surface of the pond. The next outlet is sized for the release of other smaller storm events (2- or 10-yr). The primary outlet (often an orifice) invert is located at the maximum elevation associated with the extended detention water quality volume and is sized through routing to release flow at or below the pre-100-yr levels.

The following types of orifices that may be encountered in a typical pond design are as follows:

- a. Pond drain (to allow maintenance and construction)
- b. Permanent pool orifice (to control volume and allow drawdown)
- c. WQ<sub>v</sub> orifice (for ED and MicroPool to control live pool elevation)
- d. Outlets at required flow attenuation levels to control peaks.

Alternative hydraulic control methods to an orifice can be used and include the use of a broad-crested rectangular, V-notch, or proportional weir, or an outlet pipe protected by a hood that extends at least 12 inches below the permanent pool.

19. The water quality outlet (if designed for a wet ED or micropool ED pond) must be fitted with adjustable gate valves or other mechanism that can be used to adjust detention time.
20. Higher flows pass through openings or slots protected by trash racks further up the riser.
21. Anti-seep collars must be installed on the outlet barrel and an anti-vortex device must be incorporated into the outlet barrel. An energy dissipater must be installed at the stormwater pond pipe outlet to prevent scour at the outlet.





22. Stormwater ponds must have a bottom drain with an adjustable valve that can completely drain the pond within 24 hours. The pond drain should be sized one pipe size larger than the calculated design diameter. The drain valve is typically a handwheel activated knife or gate valve. Valve controls must be located inside of the riser at a point where they will not likely be inundated and can be operated in a safe manner.
23. Access to the riser must be provided by lockable manhole covers and manhole steps within easy reach of valves and other controls.

#### Outlet Design Considerations

24. Proper hydraulic design of the outlet is critical to achieving good performance of the stormwater pond. The two most common outlet problems that occur are: 1) the capacity of the outlet is too great resulting in partial filling of the basin and less than the intended drawdown time and 2) the outlet clogs because it is not adequately protected against trash and debris. To avoid these problems, two alternative outlet types are recommended for use: 1) Notched weir and 2) perforated riser. The notched weir will not clog as easily, and is therefore preferred. Details for designing outlets/orifices are found in the Design Procedures Step # 6.

#### Emergency spillway

25. An emergency spillway must be included in the stormwater pond design to safely pass large storm events. The spillway prevents overtopping of the embankment in large storm events and causing structural damage. The emergency spillway must be located so that downstream structures will not be impacted by spillway discharges.
26. A minimum of 2 feet of freeboard must be provided, measured from the top of the water surface elevation for the 100-year storm event to the lowest point on the top of berm. The emergency spillway crest elevation will be slightly below the 100-year storm elevation, determined by the amount of flow calculated over the weir to match post- to pre-conditions.

#### Landscaping

27. Aquatic vegetation can play an important role in pollutant removal in a stormwater pond. In addition, vegetation can enhance the appearance of the pond, stabilize the side slopes and serve as wildlife habitat. Therefore, wetland plants are encouraged in a pond design, along with the aquatic bench (fringe wetlands), the safety bench and side slopes, and within shallow areas of the pool itself. The best elevations for establishing wetland plants, either by transplantation or volunteer colonization, are within 6 inches (plus or minus) of the permanent pool elevation.

Information about appropriate wetland plants can be found at TVA's Native Plant Selector site page: <http://www.tva.gov/river/landandshore/stabilization/plantsearch.htm>.

28. Woody vegetation must not be planted on the embankment or allowed to grow within 15 feet of the toe of the embankment and within 25 feet from the principle spillway.
29. Fish such as *Gambusia affinis* can be stocked for mosquito control if necessary.
30. A fountain or aerator may be beneficial for oxygenating water in the permanent pool. Considerations must be given in the design of this fountain or aerator not to disturb settling within the pond or prevent settling. Use of such fountains is discouraged during storm events.



## TSS – 01 SECTION 5: AS-BUILT CERTIFICATION

An as-built certification of the pond must be performed by a Professional Engineer. The as-built certification must verify that the BMP was installed as designed and approved. If components of the stormwater pond constructed in the field differ from the design approved by the Program, the as-built certification must:

1. Note any differences between the measure in the field and the design approved by the Program;
2. Demonstrate that the design meets the requirements of the Program; and/or
3. Propose additional measures to be included on the site to mitigate the differences.

The following components should be addressed in the as-built certification:

- a. Sediment forebay of sufficient size to pretreat runoff.
- b. Access to all components of the pond.
- c. Sufficient water depth to prevent the creation of stagnant water.
- d. Depth of treatment area.
- e. Side slopes and benches created as noted in the plans.
- f. Properly functioning spillway systems.

## TSS – 01 SECTION 6: INSPECTION AND MAINTENANCE

Each BMP must have a Hamilton County Water Quality Stormwater Management Facility I&M Storm Water Management Facilities Agreement submitted for approval and maintained and updated by the BMP owner. The Stormwater Management Facilities I&M Agreement must be completed and submitted to the Program with the Land Disturbance permit application. The Stormwater Management Facilities I&M Agreement is for the use of the BMP owner in performing routine inspections. The developer/owner is responsible for the cost of maintenance and annual inspections. The BMP owner must maintain and update the BMP inspections and maintenance plan.

At a minimum, the inspections and maintenance plan must address:

- ❖ The inspection of the embankment and spillway components;
- ❖ The removal of sediment deposits from the forebay and permanent pool area;
- ❖ The removal of spillway blockages or dead vegetation.

## TSS – 01 SECTION 7: DESIGN PROCEDURES

Design Procedures for standard wet pond, extended detention, and micropool extended detention ponds are described separately below. Some of the steps for extended detention and micropool extended detention ponds are the same as for a standard wet pond and these common steps will refer back to the standard wet pond design steps.

### Wet Pond

#### Step 1. Compute the Water Quality Volume.

Calculate (WQ<sub>v</sub>).

Equation TSS-01-01



$$WQ_v = 1.1 \times P \times R_v \times A/12$$

Where:

$WQ_v$  = water quality treatment volume, ac-ft

$P$  = 1.0 inch

$R_v$  = volumetric runoff coefficient (See Section 1 Chapter 3.1)

$A$  = contributing drainage area, acres

**Step 2. Determine if the development site and conditions are appropriate for the use of the wet pond.**

Consider the Site and Design Considerations discussed previously in this section. Available land area and drainage area are key components.

**Step 3. Determine pretreatment volume.**

A sediment forebay is sized for each inlet, unless the inlet provides less than 10% of the total design storm inflow to the pond. The forebay should be sized to contain 0.1 inches per impervious acre of contributing drainage and should be 4-6 feet deep. The forebay storage volume ( $F_v$ ) counts toward the total  $WQ_v$  requirement and may be subtracted from the  $WQ_v$  for subsequent calculations.

**Equation TSS-01-02**

$$F_v = 0.1 \text{ inches} \times A_i \text{ acres} \times .0833$$

Where:

$F_v$  = Forebay volume (ac-ft)

$A_i$  = Impervious area of drainage basin, acres

0.0833 = conversion factor of acre inches to acre feet

Often, it is more manageable to work with forebay volumes in cubic feet rather than acre feet, because they are small volumes. To convert  $F_v$  in acre feet to cubic feet, multiply  $F_v$  by 43560 square feet.

**Step 4. Determine permanent pool volume.**

Size permanent pool volume to 1.0  $WQ_v$ .

**Step 5. Determine pond preliminary geometry and storage available for pool areas.**

Establish contours and determine the stage-storage relationship for the pond. Include safety and aquatic benches. Any live pool volume is dependent on the necessity for flow attenuation only. If no flow attenuation is necessary, no live pool is necessary.

**Step 6. Size the outlet system for other storm events.**

If the pond is to serve as a multifunctional pond addressing flow attenuation, the downstream impacts must be considered for the 2- through 100-year storm events. Determine the downstream point in the watershed where the proposed site makes up 10% or less of the total drainage area to the point in question (considered the 10% point). Check the peak discharge for pre- and post-development runoff rates at the 10% point and at major junctions within the downstream watershed. Where an increase is realized, the stormwater pond can be designed for flow attenuation to the pre-development runoff rate or less through the use of multiple orifices in the primary spillway structure.





Establish a stage-storage-discharge relationship for the design storms of interest, based upon the downstream analysis.

**Step 7. Design embankment and spillway.**

Size emergency spillway for any overtopping of pond in case of rain event in excess of 100-year and for instances of malfunction/clogging of primary outlet structure.

**Step 8. Investigate potential dam hazard classification.**

The design and construction of ponds in Tennessee must follow the requirements of the Safe Dams Act. Contact the Tennessee Department of Environment and Conservation, Division of Water Supply for more information about building dams in Tennessee.

**Step 9. Design inlets, sediment forebays, outlet structures, maintenance access and safety features.**

See the *Site and Design Considerations* section for information on design.

**Step 10. Prepare the vegetation and landscaping plan.**

See the Landscaping section of *Site and Design Considerations* section.

**Wet Extended Detention (ED) Pond**

**Step 1. Compute the Water Quality Volume.**

Calculate ( $WQ_v$ ).

$$\text{Equation TSS-01-01} \\ WQ_v = 1.1 \times P \times R_v \times A/12$$

Where:

$WQ_v$  = water quality treatment volume, ac-ft

P = 1.0 inch

$R_v$  = volumetric runoff coefficient (See Section 1 Chapter 3.1)

A = contributing drainage area, acres

**Step 2. Determine if the development site and conditions are appropriate for the use of the wet ED pond.**

See standard Wet Pond Design Procedures Step 2.

**Step 3. Determine pretreatment volume.**

See standard Wet Pond Design Procedures Step 3.

**Step 4. Determine permanent pool volume.**

Size permanent pool volume to  $0.5 WQ_v$ . Size extended detention volume to  $0.5 WQ_v$ .

**Step 5. Determine pond preliminary geometry and storage available for pool areas.**

Establish contours and determine the stage-storage relationship for the pond. Include safety and aquatic benches. Set permanent pool elevation and live pool elevation based on volume calculated previously.

**Step 6. Compute extended detention orifice release rate(s).**



Based on the elevations established in Step 5 for the extended portion of the water quality volume, the water quality orifice is sized to release this extended detention volume in 24-48 hours. The water quality orifice should have a minimum diameter of 3 inches or use the perforated riser pipe and should be adequately protected from clogging by an acceptable external trash rack. A reverse slope pipe attached to the riser, with its inlet submerged 1 foot below the elevation of the permanent pool, is a recommended design. Adjustable gate valves can also be used to achieve this equivalent diameter.

Three different types of control structures are listed below.

### Flow Control Using a “V” Notch Weir

The outlet control “V” notch weir should be sized using the following formula (Metro, 2000). See Figure 1.8

#### Equation TSS-01-03

$$Q = C_1 H^{5/2} \tan \left( \frac{\theta}{2} \right)$$

Where:

$\theta$  = notch angle, in degrees

H = head or elevation of water over the weir, ft

$C_1$  = discharge coefficient (see Figure 1.9)

The notch angle should be 20° or more. If calculations show that a notch angle of less than 20° is appropriate, then the outlet should be designed as a uniform width notch. This will generally necessitate some sort of floatables control such as a skimmer on the outlet or trash rack on the inlet.

### Flow Control Using a Single Orifice

The outlet control orifice should be sized using the following equation (Metro, 2000).

#### Equation TSS-01-04

$$a = \frac{2A(H - H_o)^{0.5}}{3600CT(2g)^{0.5}}$$

Where:

a = area of orifice (ft<sup>2</sup>)

A = average surface area of the pond (ft<sup>2</sup>)

C = orifice coefficient, 0.66 or 0.80

T = drawdown time of pond (hrs)(must be greater than 24 hours)

g = gravity (32.2 ft./sec<sup>2</sup>)

H = elevation when pond in full (ft.)

$H_o$  = final elevation when pond is at permanent pool elevation (ft.)

With a drawdown time of 40 hours the equation becomes:

#### Equation TSS-01-05

$$a = \frac{(1.75 \times 10^{-5})A(H - H_o)^{0.5}}{CT}$$



Care must be taken in the selection of “C”: 0.60 is most often recommended and used. However, based on actual tests the following is recommended:

- C = 0.66 for thin materials, that is, the thickness is equal to or less than orifice diameter
- C = 0.80 when the material is thicker than the orifice diameter

Drilling the orifice into an outlet structure that is made of concrete can result in considerable impact on the coefficient, as does the beveling of the edge.

**Flow Control Using the Perforated Riser**

For outlet control using the perforated riser as the outflow control, incorporate flow control for the small storms in the perforated riser but also provide an overflow outlet for large storms, as illustrated in Figure 1.10. If properly designed, see Table 1.1, the facility can be used for both water quality and quantity control by: 1) sizing the perforated riser as indicated for water quality control; 2) sizing the outlet pipe to control peak outflow rate from the 2-year storm; and 3) using a spillway in the pond berm to control the discharge from larger storms up to the 100-year storm. To prevent clogging of an orifice and the bottom orifices of the riser pipe, wrap the bottom three rows of orifices with geotextile fabric and a cone of one to three inch rock.

**Table TSS-01-01 Perforated Riser Sizing Guidance (Metro, 2000)**

Riser Pipe Diameter	Vertical Spacing Between Rows (Center to Center)	Number of Perforations	Perforation Diameter
6 in. (15.2 cm)	2.5 in. (6.4 cm)	9 per row	1 in. (2.54 cm)
8 in. (20.3 cm)	2.5 in. (6.4 cm)	12 per row	1 in. (2.54 cm)
10 in. (25.4 cm)	2.5 in. (6.4 cm)	16 per row	1 in. (2.54 cm)

**Step 7. Size the primary spillway system for other storm events.**

See standard Wet Pond Design Procedures Step 6.

**Step 8. Design embankment and spillway.**

Size emergency spillway for any overtopping of pond in case of rain event in excess of 100-year and for instances of malfunction/clogging of primary outlet structure.

**Step 9. Investigate potential dam hazard classification.**

The design and construction of ponds in Tennessee must follow the requirements of the Safe Dams Act. Contact the Tennessee Department of Environment and Conservation, Division of Water Supply for more information about building dams in Tennessee.

**Step 10. Design inlets, sediment forebays, outlet structures, maintenance access and safety features.**

See the *Site and Design Considerations* section for information on designing these features.

**Step 11. Prepare the vegetation and landscaping plan.**

See the Landscaping section of *Site and Design Considerations* section.

**Micropool ED Pond**

**Step 1. Compute the Water Quality Volume.**





Calculate ( $WQ_v$ ).

$$\text{Equation TSS-01-01}$$
$$WQ_v = 1.1 \times P \times R_v \times A/12$$

Where:

$WQ_v$  = water quality treatment volume, ac-ft.

$P$  = 1.0 inch

$R_v$  = volumetric runoff coefficient (See Section 1 Chapter 3.1)

$A$  = contributing drainage area, acres

**Step 2. Determine if the development site and conditions are appropriate for the use of the wet pond.**

See standard Wet Pond Design Procedures Step 2.

**Step 3. Determine pretreatment volume.**

See standard Wet Pond Design Procedures Step 3.

**Step 4. Determine permanent pool volume.**

Size permanent pool volume to minimum of either 20% of  $WQ_v$  or 0.1 inch per impervious acre. Size extended detention volume (live pool) to remainder of  $WQ_v$ .

**Step 5. Determine pond preliminary geometry and storage available for pool areas.**

Establish contours and determine the stage-storage relationship for the pond. Include safety and aquatic benches. Set micropool permanent pool elevation and live pool elevation based on volume calculated previously.

**Step 6. Compute extended detention orifice release rate(s).**

See standard Wet ED Design Procedures Step 6.

**Step 7. Size the primary spillway system for other storm events.**

See standard Wet Pond Design Procedures Step 6.

**Step 8. Design embankment and spillway.**

Size emergency spillway for any overtopping of pond in case of rain event in excess of 100-year and for instances of malfunction/clogging of primary outlet structure.

**Step 9. Investigate potential dam hazard classification.**

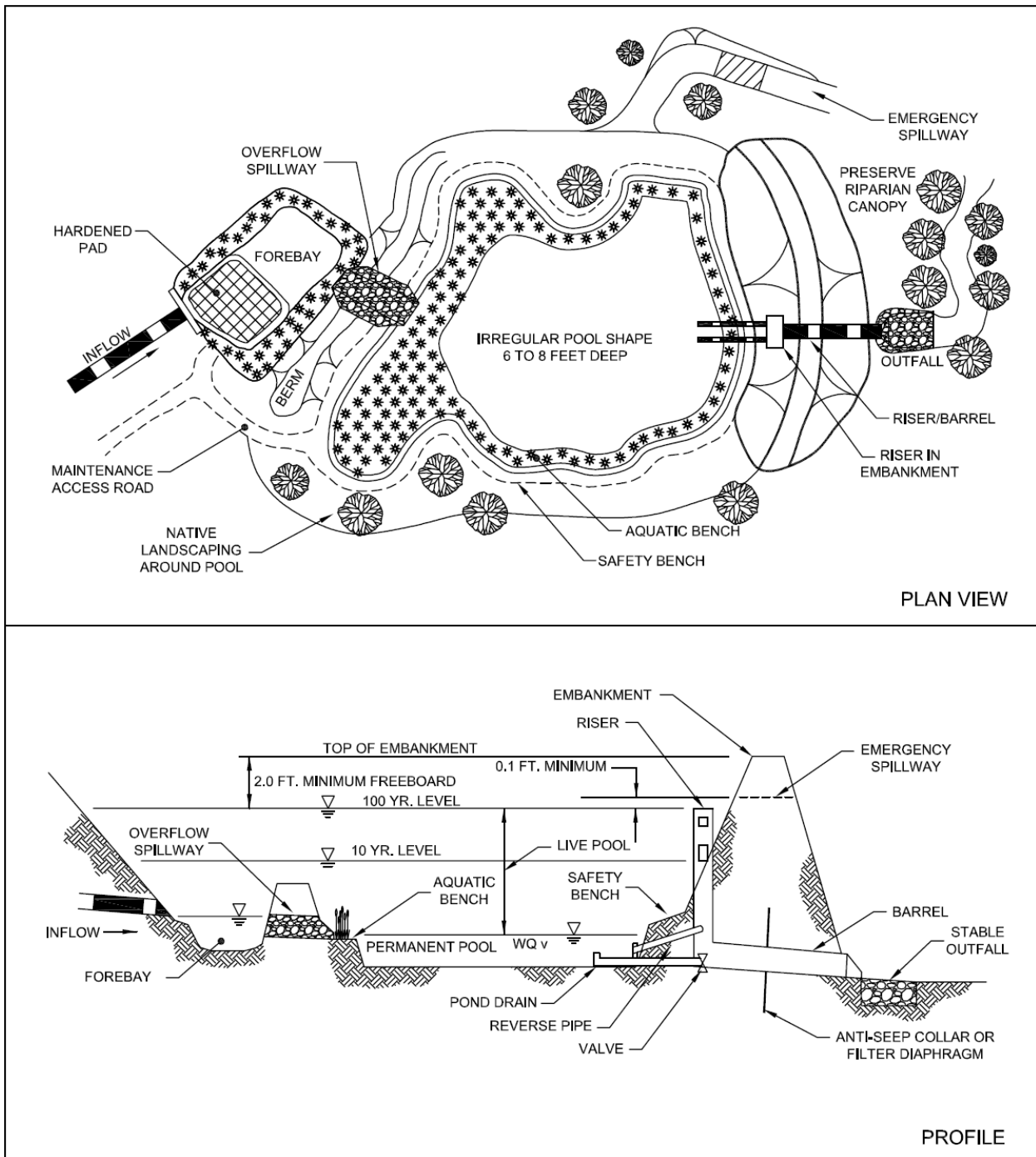
The design and construction of ponds in Tennessee must follow the requirements of the Safe Dams Act. Contact the Tennessee Department of Environment and Conservation, Division of Water Supply for more information about building dams in Tennessee.

**Step 10. Design inlets, sediment forebays, outlet structures, maintenance access and safety features.**

See the *Site and Design Considerations* section for information on designing these features.

**Step 11. Prepare the vegetation and landscaping plan.**

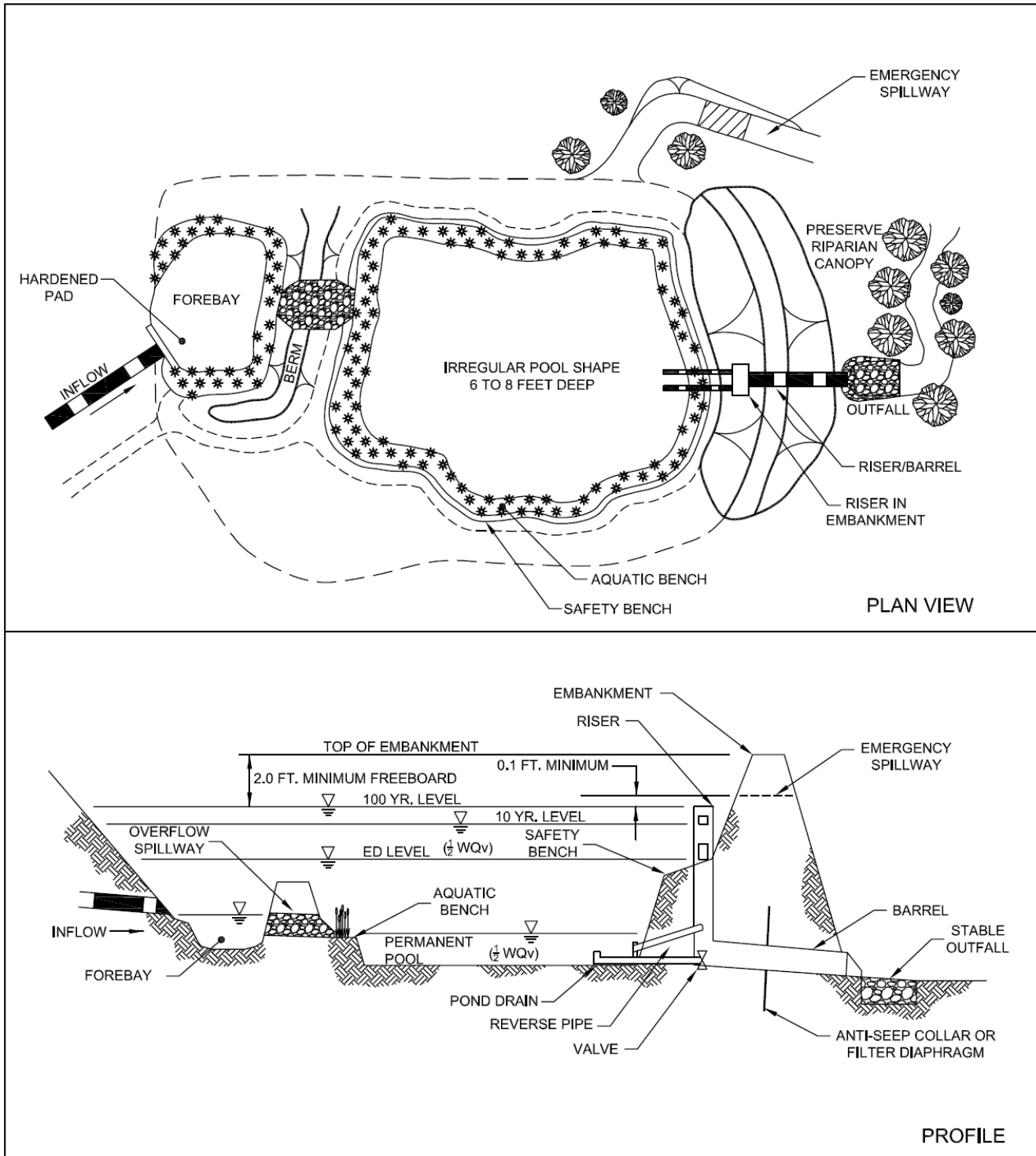
See the Landscaping section of *Site and Design Considerations* section.



**Note: Storm attenuation levels vary depending on site detention requirements.**

*(Adapted from the Center for Watershed Protection)*

**Figure TSS-01-01. Typical Schematic for a Wet Pond**

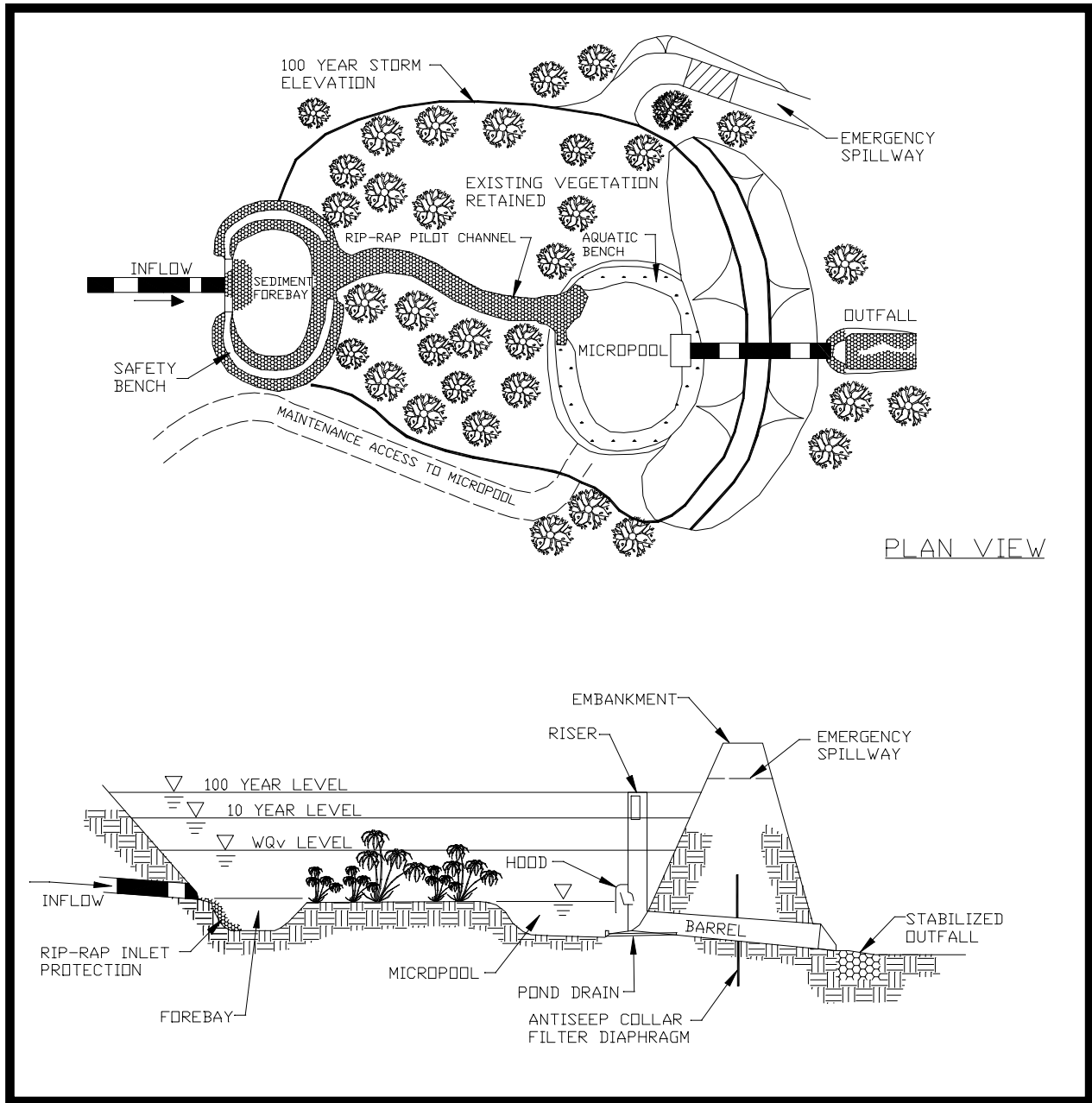


**Note: Storm attenuation levels vary depending on site detention requirements.**

(Adapted from the Center for Watershed Protection)

**Figure TSS-01-02. Wet Extended Detention Pond**

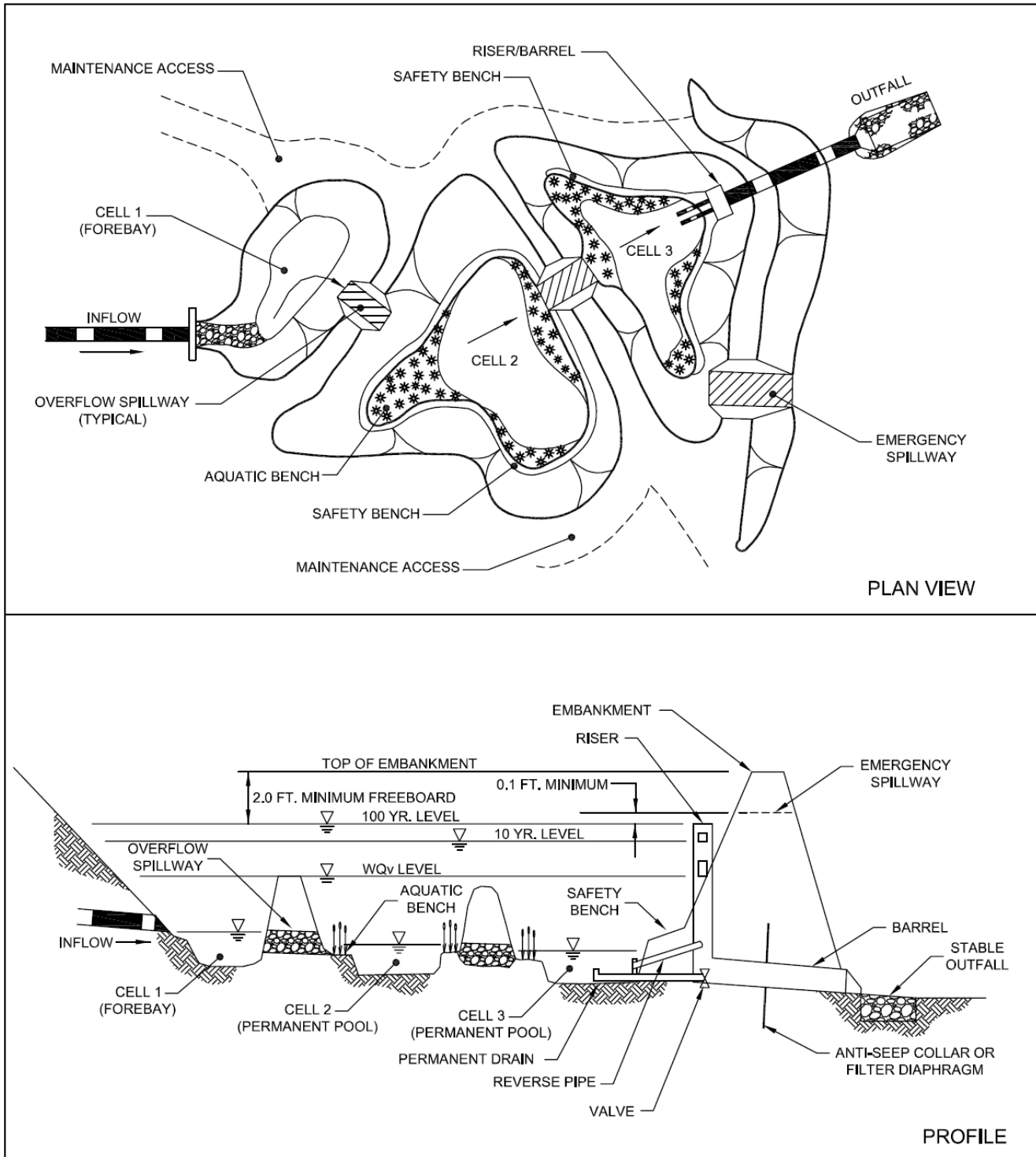




**Note: Storm attenuation levels vary depending on site detention requirements.**

(Source: Center for Watershed Protection)

**Figure TSS-01-03. Micropool Extended Detention Pond**



**Note: Storm attenuation levels vary depending on site detention requirements.**

(Adapted from the Center for Watershed Protection)

**Figure TSS-01-04. Multiple Pond System**

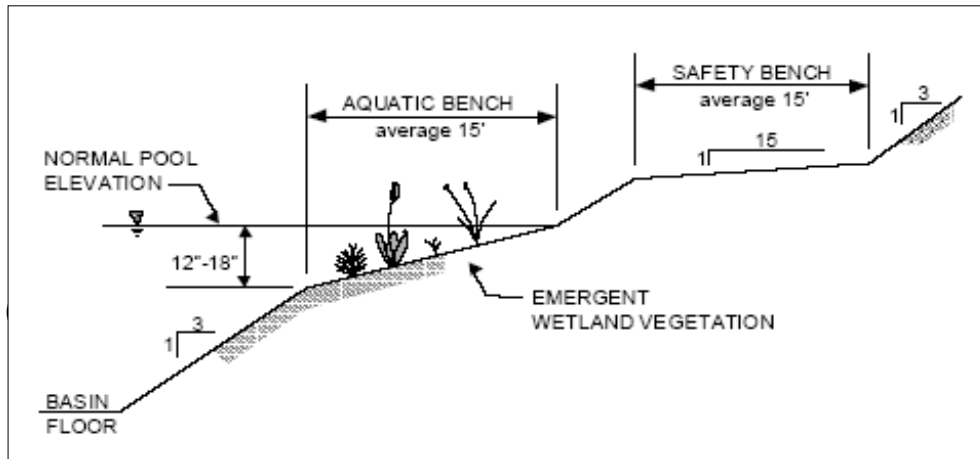
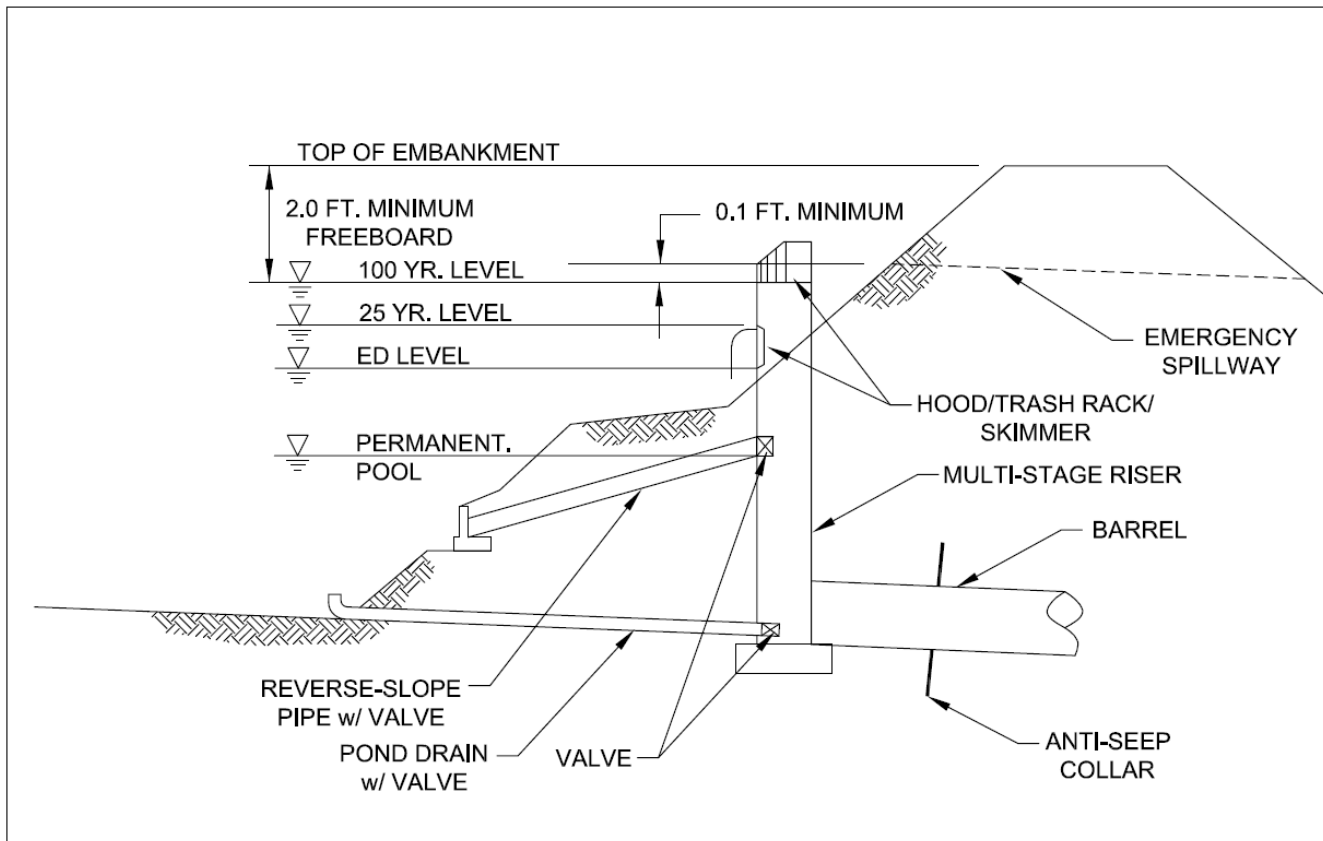


Figure TSS-01-05. Stormwater Pond Cross-Section with Benches



(Adapted from the Center for Watershed Protection)

Figure TSS-01-06. Outlet Configuration (Includes Extended Detention Level)



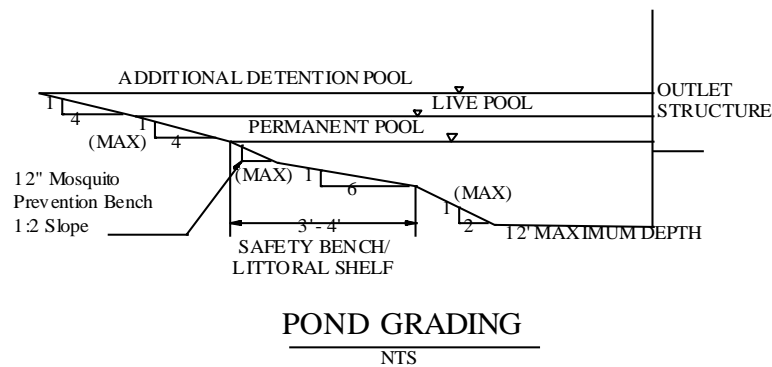
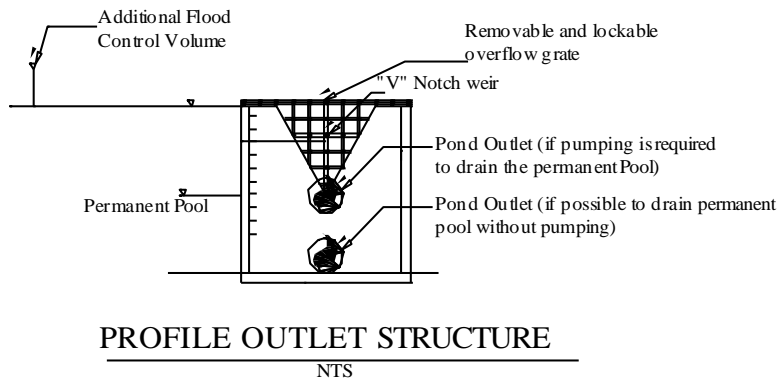
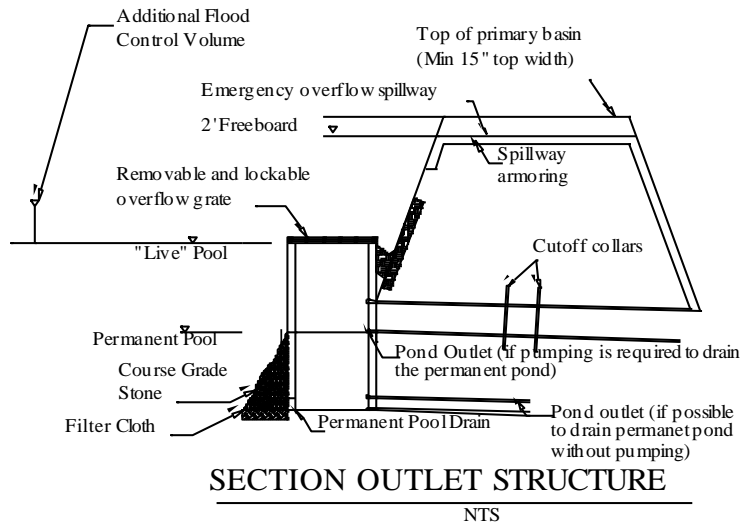


Figure TSS-01-07. V-Notch Weir Outlet Structure

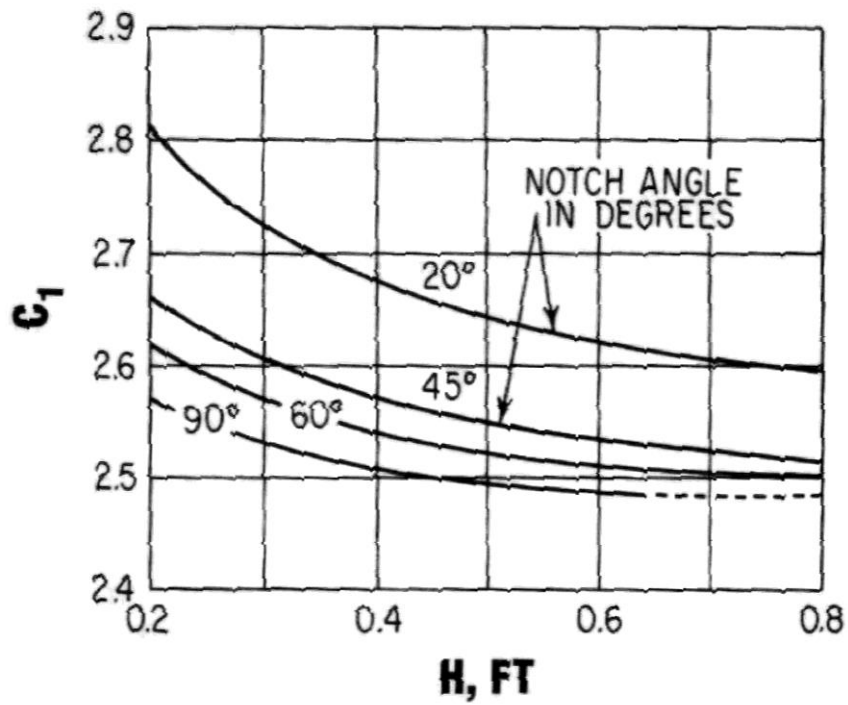
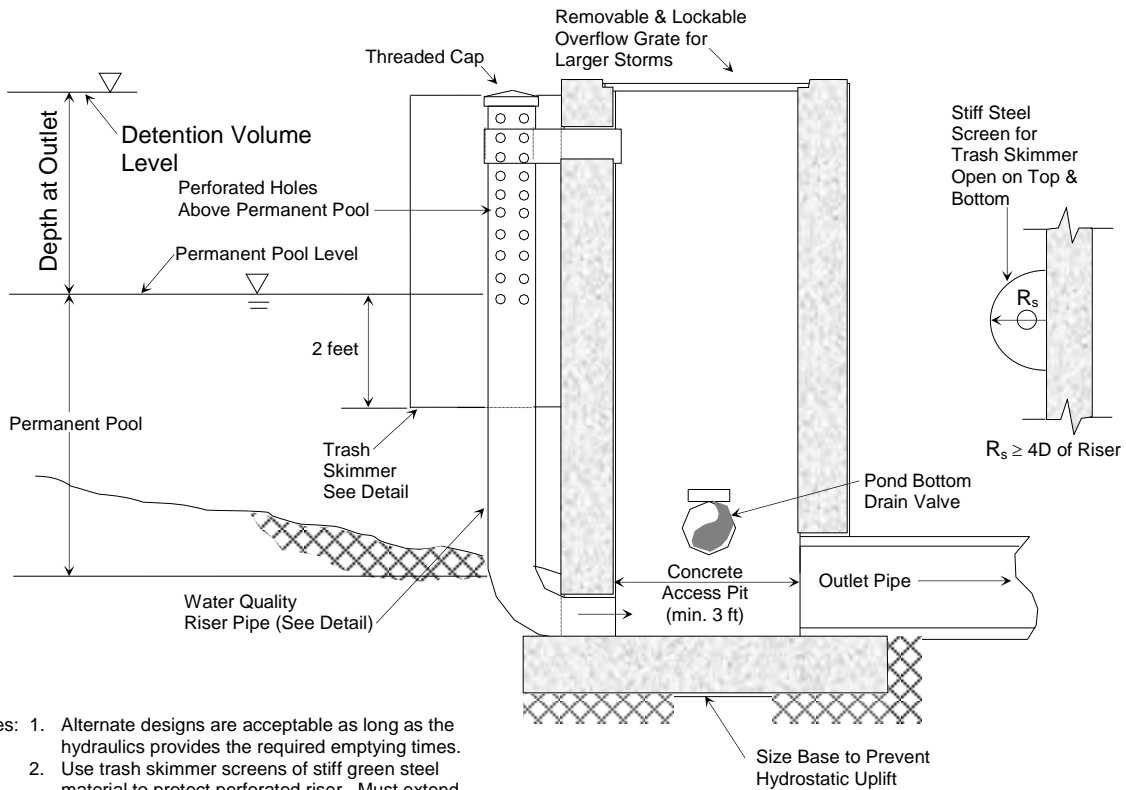


Figure TSS-01-08. Sharp-Crested V-Notch Weir Discharge Coefficients

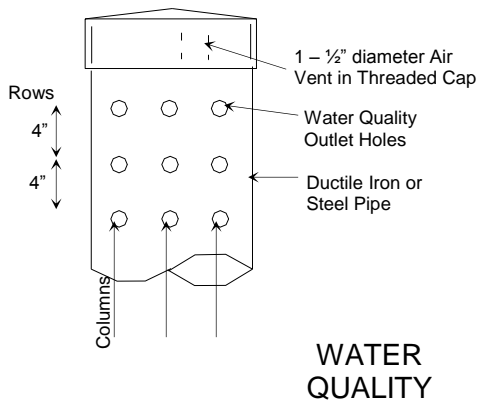


- Notes: 1. Alternate designs are acceptable as long as the hydraulics provides the required emptying times.  
 2. Use trash skimmer screens of stiff green steel material to protect perforated riser. Must extend from the top of the riser to 2 ft. below the permanent pool level.

### OUTLET WORKS

See Table TSS-01-01 for perforated riser design guidance.

- Notes: 1. Minimum number of holes = 8  
 2. Minimum hole diameter = 1/8" Dia.



Maximum Number of Perforated Columns				
Riser Diameter (in.)	Hole Diameter, inches			
	1/4"	1/2"	3/4"	1"
4	8	8	-	-
6	12	12	9	-
8	16	16	12	8
10	20	20	14	10
12	24	24	18	12
Hole Diameter (in.)		Area (in. <sup>2</sup> )		
1/8		0.013		
1/4		0.049		
3/8		0.110		
1/2		0.196		
5/8		0.307		
3/4		0.442		
7/8		0.601		
1		0.785		

TSS-01-09. Perforated Riser Outlet Structure





## TSS – 01 SECTION 8: REFERENCES

ARC, 2001. Georgia Stormwater Management Manual Volume 2 Technical Handbook.

Center for Watershed Protection, Accessed July 2005. Stormwater Manager's Resource Center. Manual Builder.  
[www.stormwatercenter.net](http://www.stormwatercenter.net).

CDM, 2000. Metropolitan Nashville and Davidson County Stormwater Management Manual Volume 4 Best Management Practices.

City of Franklin, Stormwater Management Program. January 2014. *City of Franklin Stormwater Best Management Practices Manual*,



## Constructed Wetland



## TSS - 02

Hamilton County



Water Quality Program

**Description:** Constructed wetland systems that are designed specifically for the purpose of managing stormwater. Runoff volume is stored and pollutants are removed in the wetland facility.

**Variations:** Pocket wetland, pond/wetland system, shallow wetland, extended detention shallow wetland.

**Components:**

- Ponding area – for water quality treatment through settling, biological, and chemical processes
- Marsh area – for water quality treatment through plant uptake; provides some filtering as well
- Forebay – settles larger sediments before entering pond; aids maintenance
- Spillway system(s) – provides control of pond discharge

**Advantages/Benefits:**

- High removal of typical urban stormwater pollutants
- Provides habitat for wildlife
- Can be designed for multi-objective use, including water quantity control
- Can be designed to treat stormwater from multiple developments

**Disadvantages/Limitations:**

- Requires a large amount of land to construct
- Can cause nuisance problems if not properly designed, installed and maintained
- Needs constant source of water to maintain function
- Wetland area can quickly become filled with sediment, causing the wetland to fail
- Warm water discharged from wetland can cause habitat degradation downstream

Design considerations: Continued on next page....

**Selection Criteria:**

- Water Quality  
80 % TSS Removal**
- Accepts Hotspot  
Runoff**
- Residential  
Subdivision**
- High Density /  
Ultra Urban Use**

**Maintenance:**

- Remove accumulated sediments
- Remove invasive vegetation
- Harvest vegetation every 5 years to prevent overgrowth of plants and a reduced water storage

**M** **Maintenance Burden**

L = Low M = Moderate H = High



## TSS – 02 SECTION 1: DESCRIPTION

### Design considerations:

- Minimum drainage area is 25 acres; 5 acres for pocket wetland
- Flow path through the wetland system should be 2:1 (length: width); may need serpentine system to be created internally
- Must design marsh area and ponding area through a water balance to ensure wetland does not fail in droughts

Constructed wetlands, or stormwater wetlands, are constructed basin marsh systems that are designed to both treat urban stormwater for pollutants and control runoff volumes. The basin has a sediment forebay for coarse sediments. Runoff then flows through shallow marsh (also called, high marsh) and deep marsh (also called, low marsh) areas (see Figure 2.1). As stormwater runoff flows through the wetland facility, pollutant removal is achieved through settling and uptake by

marsh vegetation. Wetlands are among the most effective stormwater practices for pollutant removal and they offer aesthetic value and wildlife habitat. Constructed stormwater wetlands differ from natural wetland systems because they are engineered facilities designed specifically for the purpose of treating stormwater runoff and typically have less biodiversity than natural wetlands both in terms of plant and animal life. However, as with natural wetlands, stormwater wetlands require a continuous base flow or a high water table to support aquatic vegetation.

There are several design variations of the stormwater wetland. Each design differs in the relative amounts of shallow and deep water, and dry storage above the wetland. These include the shallow wetland, the extended detention shallow wetland, pond/wetland system and pocket wetland. Below are descriptions of each design variant.

**Shallow Wetland** – In the shallow wetland design, most of the water quality treatment volume is in high marsh or relatively shallow low marsh depths. The only deep portions of the shallow wetland design are the forebay at the inlet to the wetland, and the micropool at the outlet. One disadvantage of this design is that, since the marsh area is very shallow, a relatively large amount of land is typically needed to store the water quality volume.

**Extended Detention (ED) Shallow Wetland** – The extended detention (ED) shallow wetland design is the same as the shallow wetland; however, part of the water quality treatment volume is provided as extended detention above the surface of the marsh and released over a period of 24 hours. This design can treat a greater volume of stormwater in a smaller space than the shallow wetland design. In the extended detention wetland option, plants that can tolerate both wet and dry periods need to be specified in the ED zone, since plants this zone is sometimes dry.

**Pond/Wetland Systems** – The pond/wetland system has two separate cells: a wet pond and a shallow marsh. The wet pond traps sediments and reduces runoff velocities prior to entry into the wetland, where stormwater flows receive additional treatment. Information on designing wet ponds is found in TSS-01. Less land is required for a pond/wetland system than for the shallow wetland or the ED shallow wetland systems.

**Pocket Wetland** – A pocket wetland is intended for smaller drainage areas of 5 to 10 acres and typically requires excavation down to the water table for a reliable water source to support the wetland system.





## TSS – 02 SECTION 2: SITE AND DESIGN CONSIDERATIONS

### Location and Siting

1. Stormwater wetlands should normally have a minimum contributing drainage area of 25 acres or more. For a pocket wetland, the minimum drainage area is 5 acres.
2. A continuous base flow or high water table is required to support wetland vegetation. A water balance must be performed to demonstrate that a stormwater wetland can withstand a 30-day drought at summer evaporation rates without completely drawing down. (See Step #2 of Design Procedure for water balance calculation).
3. Wetland siting should also take into account the location and use of other site features such as natural depressions, buffers, and undisturbed natural areas, and should attempt to aesthetically “fit” the facility into the landscape. Bedrock close to the surface may prevent excavation.
4. Stormwater wetlands cannot be located within navigable waters of the U.S., including wetlands, without obtaining a Section 404 permit under the Clean Water Act, and any other applicable State permit. In some isolated cases, a wetlands permit may be granted to convert an existing degraded wetland in the context of local watershed restoration efforts.
5. A wetland facility may be designed as either an on-line or off-line system. It is recommended that higher flows be slowed to prevent erosion and wetland vegetation mortality.
6. For various reasons, it is suggested that wetlands be setback from certain areas. Some suggested minimum setbacks for stormwater wetland facilities are as follows:
  1. From a property line – 10 feet
  2. From a private well – 100 feet; if well is down gradient from a hotspot land use then the minimum setback is 250 feet
  3. From a septic system tank/leach field – 50 feet
  7. All utilities should be located outside of the wetland site.

### General Design

8. A well-designed stormwater wetland consists of:
  - 1) Shallow marsh areas, which vary in depth, with wetland vegetation,
  - 2) Permanent micropool, and
  - 3) Overlying zone in which runoff control volumes are stored.
9. Pond/wetland systems include a stormwater pond (see TSS-01 for design information).
10. In addition, **all wetland designs must include a sediment forebay at the inflow** to the facility to allow heavier sediments to drop out of suspension before the runoff enters the wetland marsh. (See sediment forebay design information in TSS-01).
11. Additional pond design features include an **emergency spillway, maintenance access, safety bench, wetland buffer, and appropriate wetland vegetation and native landscaping.**
12. Figures 2.2 through 2.5 provide plan view and profile schematics for the designs of shallow, ED shallow, pond/wetland, and pocket wetlands.

### Physical Specifications/Geometry

13. In general, wetland designs are unique for each site and application. However, there are number of geometric ratios and limiting depths for the design of a stormwater wetland that must be observed for adequate pollutant removal, ease of maintenance, and improved safety. Table 2.1 provides the recommended physical specifications and geometry for the various stormwater wetland design variants.



14. The stormwater wetland should be designed with the recommended proportion of “depth zones.” Each of the four wetland design variants has depth zone allocations which are given as a percentage of the stormwater wetland surface area. Target allocations are found in Table 2.1. The four basic depth zones are:
- Semi-wet zones.** Those areas above the permanent pool that are inundated during larger storm events. This zone supports a number of species that can survive flooding
  - High marsh zone.** From the permanent pool to 6 inches below the permanent pool. This zone will support a greater density and diversity of wetland species than the low marsh zone. The high marsh zone should have a higher surface area to volume ratio than the low marsh zone.
  - Low marsh zone.** From 6 to 18 inches below the permanent pool or water surface elevation. This zone is suitable for the growth of several emergent wetland plant species.
  - Deepwater zone.** From 1.5 to 6 feet deep to the top of the permanent pool elevation. Includes the outlet micropool and deepwater channels through the wetland facility. This zone supports little emergent wetland vegetation, but may support submerged or floating vegetation.

**Table TSS-02-01. Recommended Design Criteria for Stormwater Wetlands**

Modified from Massachusetts DEP, 1997; Schueler, 1992

<u>Design Criteria</u>	<u>Shallow Wetland</u>	<u>ED Shallow Wetland</u>	<u>Pond/Wetland</u>	<u>Pocket Wetland</u>
<b>Length to Width Ratio (minimum)</b>	2:1	2:1	2:1	2:1
<b>Extended Detention (ED)</b>	No	Yes	Optional	Optional
<b>Allocation of WQ<sub>v</sub> Volume (pool/marsh/ED) in %</b>	25/75/0	25/25/50	70/30/0 (includes pond volume)	25/75/0
<b>Allocation of Surface Area (deepwater/low marsh/high marsh/semi-wet) in %</b>	20/35/40/ 5	10/35/45/1 0	45/25/25/5 (includes pond surface area)	10/45/40/ 5
<b>Forebay</b>	Required	Required	Required	Optional
<b>Micropool</b>	Required	Required	Required	Required
<b>Outlet Configuration</b>	Reverse-slope pipe or hooded broad-crested weir	Reverse-slope pipe or hooded broad-crested weir	Reverse-slope pipe or hooded broad-crested weir	Hooded broad-crested weir

Depth:

*Deepwater:* 1.5 to 6 feet below permanent pool elevation

*Low marsh:* 6 to 8 inches below permanent pool elevation

*High marsh:* 6 inches or less below permanent pool elevation

*Semi-wet zone:* Above permanent pool elevation

15. A minimum dry weather flow path of 2:1 (length to width) is required from inflow to outlet across the stormwater wetland and should ideally be greater than 3:1. This path may be achieved by constructing internal dikes or berms, using marsh plantings, and by using multiple cells. Finger dikes are commonly used in



surface flow systems to create serpentine configurations and prevent short-circuiting. Microtopography (contours along the bottom of a wetland or marsh that provide a variety of conditions for different species needs and increases the surface area to volume ratio) is encouraged to enhance wetland diversity.

16. Open water zone should take up 35 to 40 percent of the total water surface area.
17. A 4 to 6 foot deep micropool must be included in the design at the outlet to prevent the outlet from clogging and resuspension of sediments, and to mitigate thermal effects.
18. Maximum depth of any permanent pool areas should generally not exceed 6 feet.
19. The volume of the extended detention must not comprise more than 50% of the total  $WQ_v$ , and its maximum water surface elevation must not extend more than 3 feet above the permanent pool. Storage for larger storms can be provided above the  $WQ_v$  elevation.
20. The perimeter of all deep pool areas (4 feet or greater in depth) should be surrounded by safety and aquatic benches similar to those for stormwater ponds (see Stormwater Ponds, TSS-01).
21. The perimeter of the wetland should be irregular to provide a more natural landscaping effect.

#### **Pretreatment/Inlets**

22. Sediment regulation is critical to sustain stormwater wetlands. A wetland facility should have a sediment forebay or equivalent upstream pretreatment. A sediment forebay is designed to remove incoming sediment from the stormwater flow prior to dispersal into the wetland. The forebay should consist of a separate cell, formed by an acceptable barrier. A forebay is to be provided at each inlet, unless the inlet provides less than 10% of the total design storm inflow to the wetland facility.
23. The forebay is sized to contain 0.1 inches per impervious acre of contributing drainage and should be 4 to 6 feet deep. The pretreatment storage volume is part of the total  $WQ_v$  requirement and may be subtracted from  $WQ_v$  for wetland storage sizing.
24. A fixed vertical sediment depth marker shall be installed in the forebay to measure sediment deposition over time. The bottom of the forebay may be hardened (e.g., using concrete, paver blocks, etc.) to make sediment removal easier.
25. Inflow channels are to be stabilized with flared riprap aprons, or the equivalent. Inlet pipes to the pond can be partially submerged. Exit velocities from the forebay must be nonerosive.

#### **Outlet Structures**

26. Flow control from a stormwater wetland is typically accomplished with the use of a concrete or corrugated metal riser and barrel. The riser is a vertical pipe or inlet structure that is attached to the base of the micropool with a watertight connection. The outlet barrel is a horizontal pipe attached to the riser that conveys flow under the embankment. The riser should be located within the embankment for maintenance access, safety and aesthetics.

A number of outlets at varying depths in the riser provide internal flow control for routing runoff volumes. The number of orifices can vary and is usually a function of the pond design.

27. For shallow and pocket wetlands, the riser configuration is typically comprised of a flood protection outlet (often a slot or weir).
28. Since the water quality volume is fully contained in the permanent pool, no orifice sizing is necessary for this volume. An off-line shallow or pocket wetland providing only water quality treatment (not ED) can use a simple overflow weir as the outlet structure.

In the case of an extended detention (ED) shallow wetland, there is generally a need for an additional outlet (usually an orifice) that is sized to pass the extended detention water quality volume that is surcharged on top





of the permanent pool. Flow will first pass through this orifice, which is sized to release the water quality ED volume in 24 hours. The preferred design is a reverse slope pipe attached to the riser, with its inlet submerged 1 foot below the elevation of the permanent pool to prevent floatables from clogging the pipe and to avoid discharging warmer water at the surface of the pond. The outlet (often an orifice) invert is located at the maximum elevation associated with the extended detention water quality volume.

Alternative hydraulic control methods to an orifice can be used and include the use of a broad-crested rectangular, V-notch, or proportional weir, or an outlet pipe protected by a hood that extends at least 12 inches below the normal pool. (Refer to Stormwater Ponds, TSS-01 for orifice equations.)

29. The water quality outlet (if design is for an ED shallow wetland) should be fitted with adjustable gate valves or other mechanism that can be used to adjust detention time.
30. Higher flows pass through openings or slots protected by trash racks further up on the riser.
31. After entering the riser, flow is conveyed through the barrel and is discharged downstream. Anti-seep collars should be installed on the outlet barrel to reduce the potential for pipe failure.
32. Riprap, plunge pools or pads, or other energy dissipaters are to be placed at the outlet of the barrel to prevent scouring and erosion. If a wetland facility daylights to a channel with dry weather flow, care should be taken to minimize tree clearing along the downstream channel, and to reestablish a forested riparian zone in the shortest possible distance.
33. The wetland facility must have a bottom drain pipe located in the micropool with an adjustable valve that can completely or partially dewater the wetland within 24 hours.
34. The wetland drain should be sized one pipe size greater than the calculated design diameter. The drain valve is typically a handwheel activated knife or gate valve. Valve controls shall be located inside of the riser at a point where they will not normally be inundated and can be operated in a safe manner.

#### **Emergency Spillway**

35. An emergency spillway is to be included in the stormwater wetland design to safely pass flows that exceed the design storm flows. The spillway prevents the wetland's water levels from overtopping the embankment and causing structural damage. The emergency spillway must be located so that downstream structures will not be impacted by spillway discharges.
36. A minimum of 2 feet of freeboard must be provided, measured from the top of the maximum design storm elevation to the lowest point of the dam embankment, not counting the emergency spillway.

#### **Maintenance Access**

37. A maintenance right of way or easement must be provided to the wetland facility from a public or private road. Maintenance access should be at least 12 feet wide, have a maximum slope of no more than 15 percent, and be appropriately stabilized to withstand maintenance equipment and vehicles.
38. The maintenance access must extend to the forebay, safety bench, riser, and outlet and, to the extent feasible, be designed to allow vehicles to turn around.
39. Access to the riser is to be provided by lockable manhole covers, and manhole steps within easy reach of valves and other controls.

#### **Safety Features**

40. All embankments and spillways must be designed to State of Tennessee guidelines for dam safety.
41. Fencing of wetlands is not generally desirable, but it may be infeasible to leave them unfenced because of community concerns. A preferred method is to manage the contours of deep pool areas through the



inclusion of a safety bench (see above) to eliminate drop-offs and reduce the potential for accidental drowning.

42. The principal spillway opening should not permit access by small children, and endwalls above pipe outfalls greater than 48 inches in diameter should be fenced to prevent a hazard.

### Landscaping

A landscaping plan should be provided that indicates the methods used to establish and maintain wetland coverage. Minimum elements of a plan include: delineation of landscaping zones, selection of corresponding plant species, planting plan, sequence for preparing wetland bed (including soil amendments, if needed) and sources of plant material. Landscaping zones include low marsh, high marsh, and semi-wet zones. The low marsh zone ranges from 6 to 18 inches below the permanent pool. This zone is suitable for the growth of several emergent plant species. The high marsh zone ranges from 6 inches below the permanent pool up to the permanent pool.

This zone will support greater density and diversity of emergent wetland plant species. The high marsh zone should have a higher surface area to volume ratio than the low marsh zone. The semi-wet zone refers to those areas above the permanent pool that are inundated on an irregular basis and can be expected to support wetland plants.

43. The landscaping plan should provide elements that promote greater wildlife and waterfowl use within the wetland and buffers.
44. Woody vegetation may not be planted on the embankment or allowed to grow within 15 feet of the toe of the embankment and 25 feet from the principal spillway structure.
45. The wetland shall have a 15-foot setback to structures.
46. To discourage resident geese populations, the area surrounding the constructed wetland can be planted with trees, shrubs and native ground covers. The soils of a wetland buffer are often severely compacted during the construction process to ensure stability. The density of these compacted soils is so great that it effectively prevents root penetration and therefore may lead to premature mortality or loss of vigor. Consequently, it is advisable to excavate large and deep holes around the proposed planting sites and backfill these with uncompacted topsoil.

### Other Constraints

- ❖ Karst – Requires poly or clay liner to sustain a permanent pool of water and protect aquifers; limits on ponding depth; geotechnical tests may be required
- ❖ Hydrologic group “A” soils and some group “B” soils may require liner (not relevant for pocket wetland)

## TSS – 02 SECTION 3: AS-BUILT CERTIFICATION

An as-built certification of the constructed wetland must be performed by a Professional Engineer. The as-built certification verifies that the BMP was installed as designed and approved. If components of the stormwater wetland constructed in the field differ from the design approved by the Program, the as-built certification must: (1) Note the differences between the measure in the field and the design approved by the Program; (2) Demonstrate that the design meets the requirements of the Program; and/or (3) Propose additional measures to be included on the site to mitigate the differences.



The following components should be addressed in the as-built certification:

- ❖ Sediment forebay of sufficient size to pretreat runoff.
- ❖ Access to all components of the wetland for maintenance
- ❖ Sufficient water depth to prevent the creation of stagnant water.
- ❖ Depth of treatment area.
- ❖ Side slopes and benches created as noted in the plans.
- ❖ Properly functioning spillway systems.

## TSS – 02 SECTION 4: INSPECTIONS AND MAINTENANCE

Each BMP must have a Hamilton County Water Quality Stormwater Management Facility I&M Storm Water Management Facilities Agreement submitted for approval and maintained and updated by the BMP owner. The Stormwater Management Facilities I&M Agreement must be completed and submitted to the Program with the Land Disturbance permit application. The Stormwater Management Facilities I&M Agreement is for the use of the BMP owner in performing routine inspections. The developer/owner is responsible for the cost of maintenance and annual inspections. The BMP owner must maintain and update the BMP inspections and maintenance plan. At a minimum, the inspections and maintenance plan must address:

1. Clean and remove debris from inlet and outlet structures.
2. Mow side slopes. Periodic mowing of the wetland buffer is only required along maintenance rights-of-way and the embankment. The remaining buffer can be managed as a meadow (mowing every other year) or forest.
3. Monitor wetland vegetation and perform replacement planting as necessary.
4. Replace wetland vegetation to maintain at least 50% surface area coverage in wetland plants after the second growing season.
5. Examine stability of the original depth zones and microtopographical features. Inspect for invasive vegetation, and remove where possible.
6. Inspect for damage to the embankment and inlet/outlet structures. Repair as necessary. Note signs of hydrocarbon build-up, and remove appropriately.
7. Monitor for sediment accumulation in the facility and forebay.
8. Examine to ensure that inlet and outlet devices are free of debris and operational.
9. Repair undercut or eroded areas.
10. Harvest wetland plants that have been “choked out” by sediment build-up. A sediment marker should be located in the forebay to determine when sediment removal is required. Monitor sediment accumulations, and remove sediment when the pool volume has become reduced significantly, plants are “choked” with sediment, or the wetland becomes eutrophic.
11. Maintenance requirements for constructed wetlands are particularly high while vegetation is being established. Monitoring during these first years is crucial to the future success of the wetland as a stormwater structural control. Wetland facilities should be inspected after major storms (greater than 2 inches of rainfall) during the first year of establishment to assess bank stability, erosion damage, flow channelization, and sediment accumulation within the wetland. For the first 3 years, inspections should be conducted at least twice a year.





12. Sediments excavated from stormwater wetlands that do not receive runoff from designated hotspots are not considered toxic or hazardous material and can be safely disposed of by either land application or landfilling. Sediment testing may be required prior to sediment disposal when a hotspot land use is present.

## TSS – 02 SECTION 5: DESIGN PROCEDURES

### Step 1. Compute the Water Quality Volume.

Calculate the Water Quality Volume ( $WQ_v$ ).

$$\text{Equation TSS-02-01} \\ WQ_v = 1.1 \times P \times R_v \times A/12$$

Where:

$WQ_v$  = water quality treatment volume, ac-ft.

$P$  = 1.0 inch

$R_v$  = volumetric runoff coefficient (See Section 1 Chapter 3.1)

$A$  = contributing drainage area, acres

### Step 2. Determine if the development site and conditions are appropriate for the constructed wetland.

See the *Site and Design Considerations* in the section, above.

Perform Water Balance calculations to ensure that drainage basin has characteristics to support permanent pool.

### Step 3. Confirm design criteria and applicability to site.

Check with Hamilton County Engineering and the Chattanooga-Hamilton County Regional Planning Agency (RPA) and other agencies to determine if there are any additional restrictions and/or surface water or watershed requirements that may apply.

### Step 4. Determine pretreatment volume.

A sediment forebay is to be provided at each inlet, unless the inlet provides less than 10% of the total design storm inflow to the pond. The forebay should be sized to contain 0.1 inches per impervious acre of contributing drainage and should be 4 to 6 feet deep. The forebay storage volume counts toward the total  $WQ_v$  requirement and may be subtracted from the  $WQ_v$  for subsequent calculations.

$$\text{Equation TSS-02-02} \\ F_v = 0.1 \text{ inches} \times A_i \text{ acres} \times .0833$$

Where:

$F_v$  = Forebay volume (ac-ft.)

$A_i$  = Impervious area of drainage basin, acres

0.0833 = conversion factor of acre inches to acre feet

Often, it is more manageable to work with forebay volumes in cubic feet rather than acre feet, because they are small volumes. To convert  $F_v$  in acre feet to cubic feet, multiply  $F_v$  by 43560 square feet.

### Step 5. Allocate the $WQ_v$ among marsh, micropool, and ED volumes.

Use recommended criteria from Table TSS-02-01.



**Step 6. Determine wetland location and preliminary geometry, including distribution of wetland depth zones.**

This step involves initially laying out the wetland design and determining the distribution of wetland surface area among the various depth zones (high marsh, low marsh, and deepwater). Set  $WQ_v$  permanent pool elevation (and  $WQ_v$ -ED elevation for ED shallow wetland) based on volumes calculated earlier.

Determine if constructed wetland is on-line or off-line. Off-line wetlands require a diversion structure to divert low flows towards wetland and high flows away from wetlands. See Figure 2.6 for example diversion structure and Figure 2.7 for an example of an off-line system.

See the Physical Specifications/Geometry section (pages 4 to 6) of *Site and Design Considerations* for more details.

**Step 7. Compute extended detention orifice release rate(s) and size(s), and establish  $WQ_v$  elevation.**

*Shallow Wetland, Pocket Wetland and ED Shallow Wetland:* Based on the elevations established in Step 6 for the extended detention portion of the water quality volume, the water quality orifice is sized to release this extended detention volume in 24 hours. The water quality orifice should have a minimum diameter of 3 inches or use a perforated riser, and should be adequately protected from clogging by an acceptable external trash rack. A reverse slope pipe attached to the riser, with its inlet submerged one foot below the elevation of the permanent pool, is a recommended design. Adjustable gate valves can also be used to achieve this equivalent diameter.

\*An off-line shallow or pocket wetland providing only water quality treatment can employ a simple overflow weir.

**Step 8. Calculate 100-year storm release rate and water surface elevation.**

Set up a stage-storage-discharge relationship for the control structure for the extended detention orifice(s) and the 100-year storm.

**Step 9. Design embankment(s) and spillway(s).**

Size emergency spillway to pass flows larger than the maximum design storm and to pass flows when the inlet bypass (for off-line systems) or outlet structures malfunction. Attenuation may not be required.

**Step 10. Design safe design velocity for on-line systems.**

For on-line systems, scour and erosion and wetland vegetation mortality may be of concern. Flow velocities must be minimis to prevent these conditions. Limit in-flow velocities to less than five feet per second into the wetland area. Energy dissipaters should be used to reduce flow velocities.

**Step 11. Investigate potential pond/wetland hazard classification.**

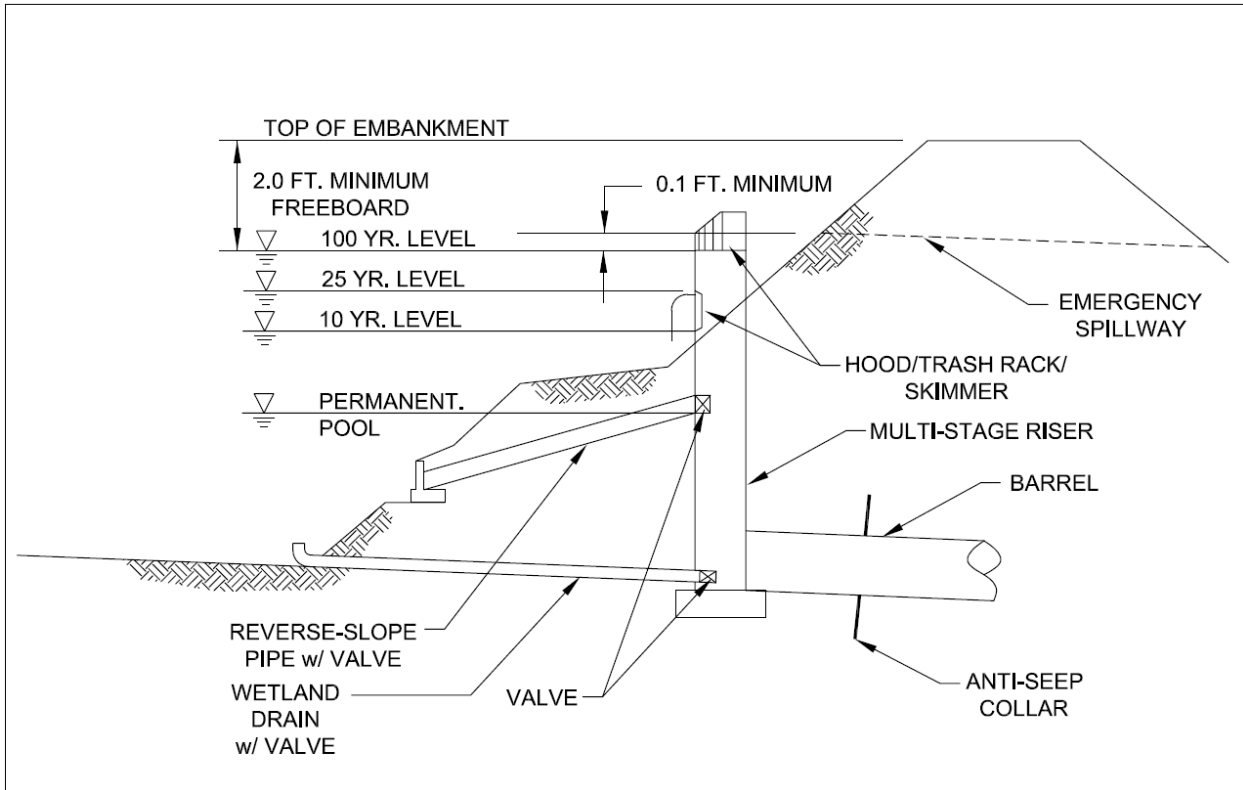
The design and construction of ponds in Tennessee must follow the requirements of the Safe Dams Act. Contact the Tennessee Department of Environment and Conservation, Division of Water Supply for more information about building dams in Tennessee.

**Step 12. Design inlets, sediment forebay(s), outlet structures, maintenance access, and safety features.**

See the *Site and Design Considerations* section for information on design.

**Step 13. Prepare Vegetation and Landscaping Plan.**

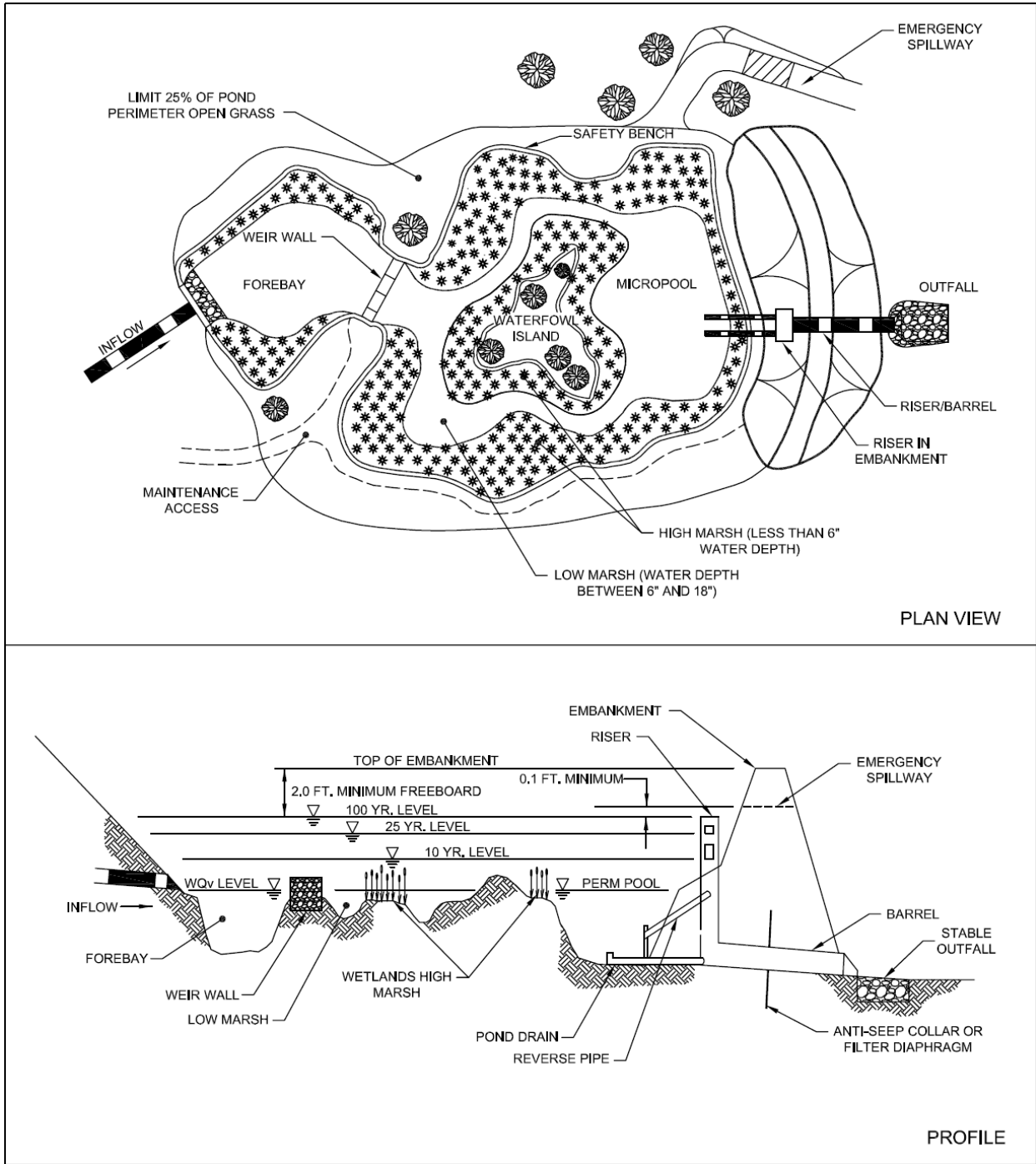
A landscaping plan for the wetland facility should be prepared to indicate how aquatic and terrestrial areas will be stabilized and established with vegetation.



(Adapted from Center for Watershed Protection)

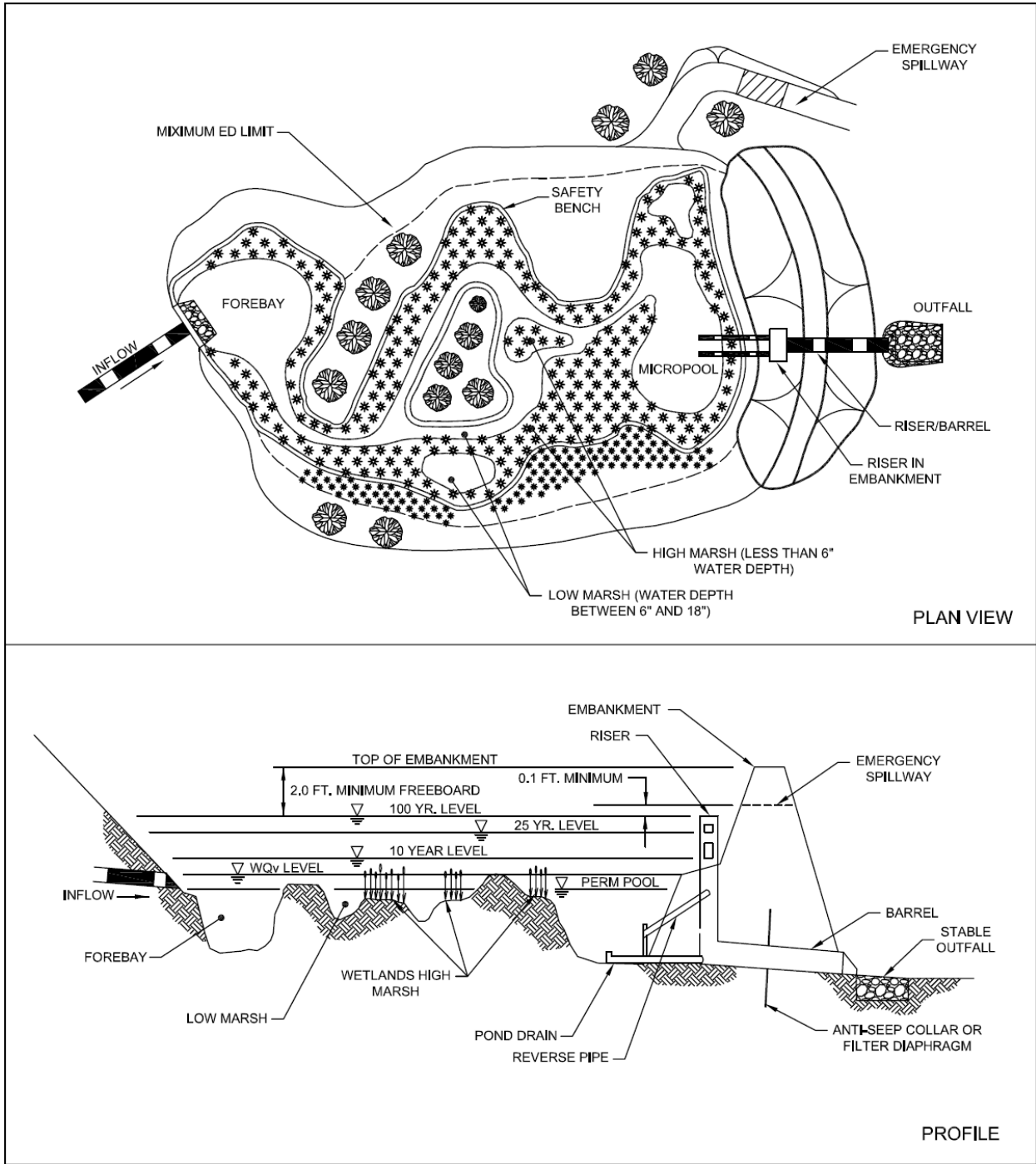
Figure TSS-02-01. Typical Wetland Facility Outlet Structure





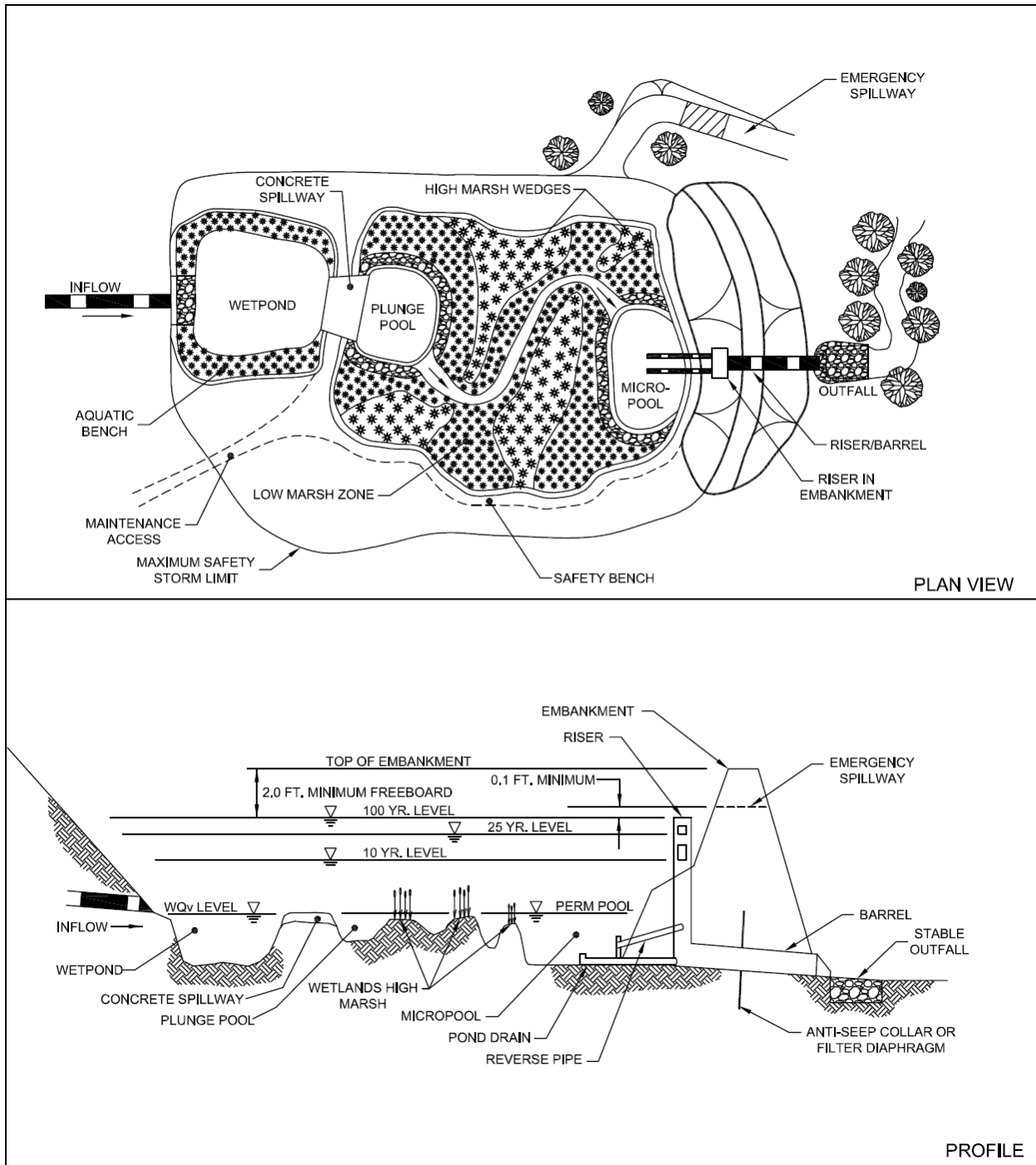
(Source: Center for Watershed Protection)

Figure TSS-02-02 Schematic of Shallow Wetland



(Adapted from Center for Watershed Protection)

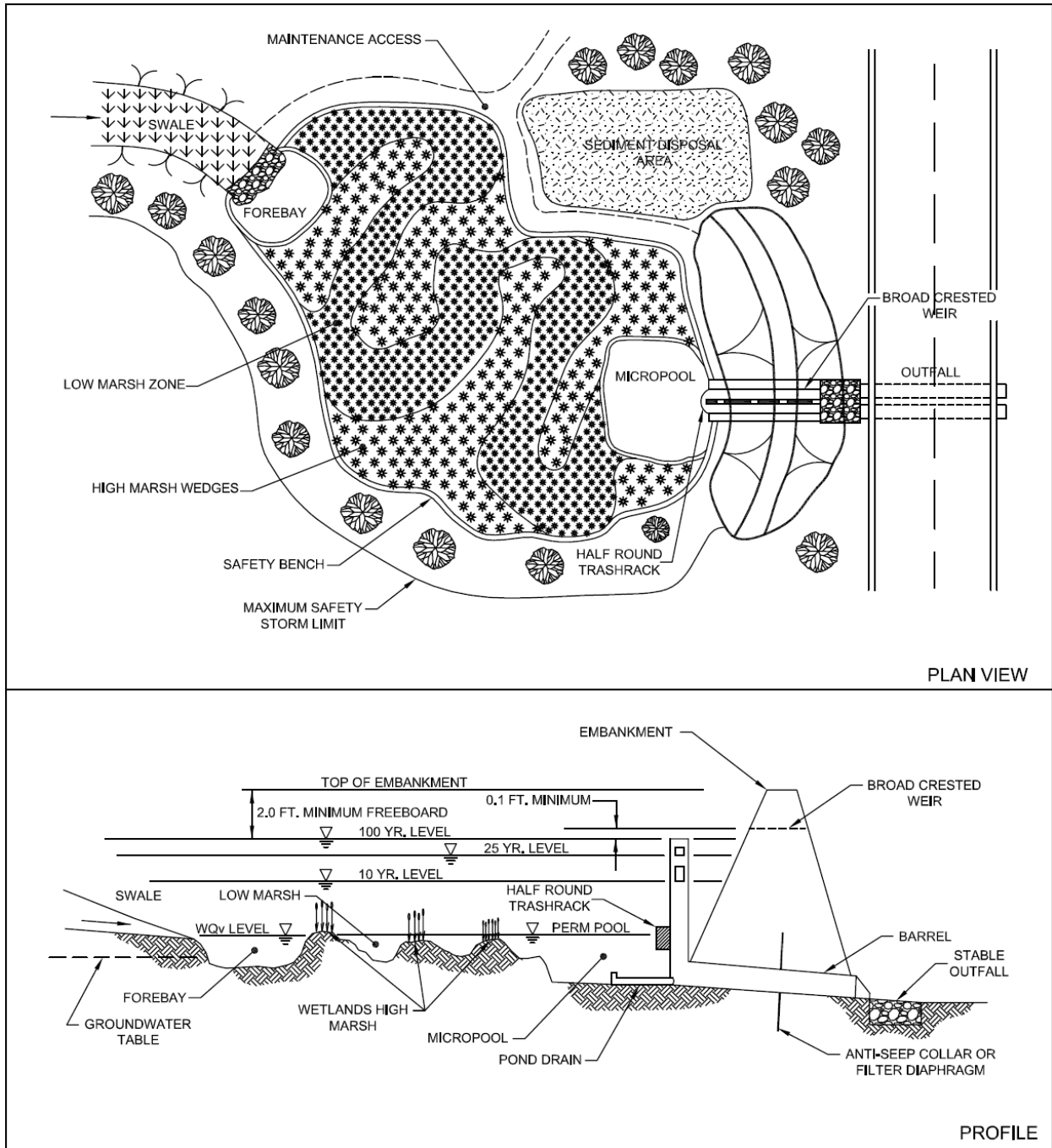
Figure TSS-02-03. Schematic of Extended Detention Shallow Wetland



(Adapted from Center for Watershed Protection)

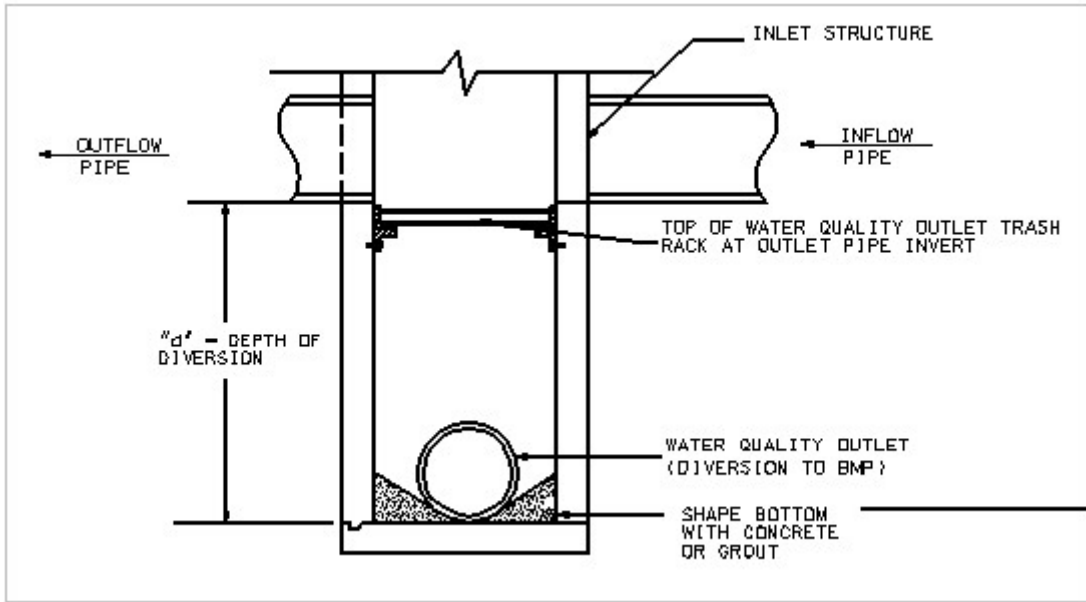
Figure TSS-02-04. Schematic of Pond/Wetland System





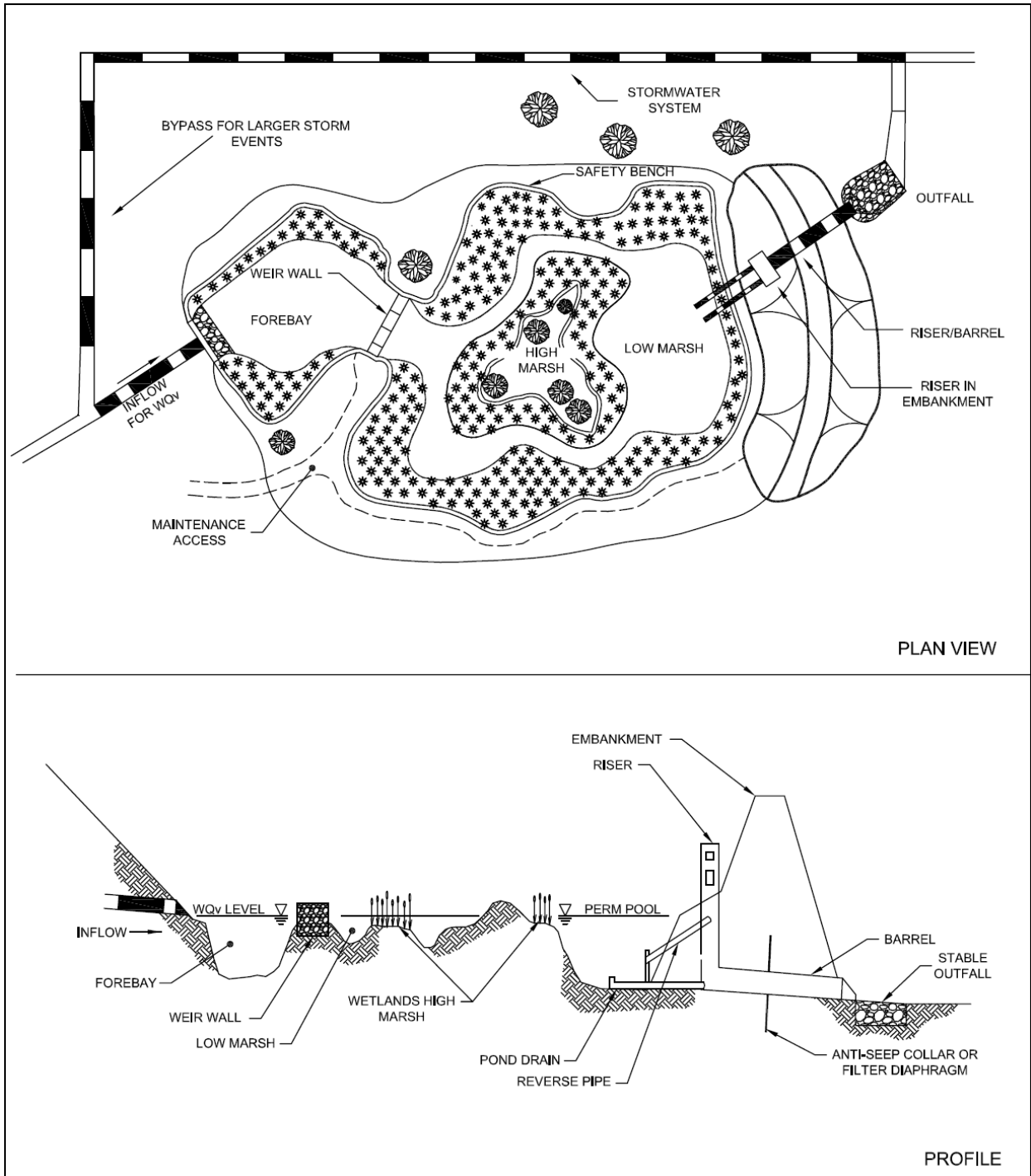
(Source: Center for Watershed Protection)

**Figure TSS-02-05. Schematic of Pocket Wetland System**



(Source: AMEC)

Figure TSS-02-06. Example Diversion Structure



(Adapted from the Center for Watershed Protection)

**Figure TSS-02-07. Example of Off-line Constructed Wetland**





## TSS – 02 SECTION 6: REFERENCES

ARC, 2001. Georgia Stormwater Management Manual Volume 2 Technical Handbook.

Center for Watershed Protection, Accessed July 2005. Stormwater Manager's Resource Center. Manual Builder. [www.stormwatercenter.net](http://www.stormwatercenter.net).

CDM, 2000. Metropolitan Nashville and Davidson County Stormwater Management Manual Volume 4 Best Management Practices.

*City of Franklin Stormwater Best Management Practices Manual*, City of Franklin, Stormwater Management Program, January 2014.



## Surface Sand Filter



TSS - 03

Hamilton County



Water Quality Program

**Description:** Multi-chamber structure designed to treat stormwater runoff through filtration, using a sediment forebay, a sand bed as its primary filter media and an underdrain collection system (typically).

**Variations:** Underground Sand Filter (TSS-08), Perimeter Sand Filter (TSS-09) and Organic Filter (TSS-10).

### Components:

- Forebay (or sedimentation chamber)—settles coarse particles and trash
- Sand bed (or Filtration) chamber—provides water quality treatment by filtering other pollutants
- Spillway system(s)— provide discharge control

### Advantages/Benefits:

- Applicable to small drainage areas
- Good for highly impervious areas
- Good for water quality retrofits to existing developments

### Disadvantages/Limitations:

- High maintenance burden
- Not recommended for areas with high sediment content in stormwater or clay/silt runoff areas
- Relatively costly
- Possible odor problems
- Typically needs to be combined with other controls to provide water quantity control

### Design considerations:

- Typically requires 2 to 6 feet of head
- Maximum contributing drainage area of 10 acres
- In karst areas use polyliner or impermeable membrane to seal bottom of earthen surface sand filter or use watertight structure

### Selection Criteria:

- Water Quality**  
80 % TSS Removal
- Accepts Hotspot**  
Runoff
- Residential**  
Subdivision
- High Density /**  
Ultra Urban Use

### Maintenance:

- Inspect for clogging—rake first inch of sand
- Remove sediment from forebay-chamber
- Replace sand filter media as needed
- Clean spillway system(s)

**H** Maintenance Burden

L = Low M = Moderate H = High



## TSS – 03 SECTION 1: DESCRIPTION

Sand filters (also referred to as *filtration basins*) are structural stormwater controls that capture and temporarily store stormwater runoff and treat it by filtering it through a bed of sand. The surface sand filter is a ground-level open air structure that consists of a pretreatment sediment forebay and a sand bed chamber. This system can treat drainage areas up to 10 acres in size and is an off-line device in which flows larger than the water quality volume by-pass the system. Surface sand filters can be designed as an excavation with earthen embankments or as a concrete or block structure. The filtered runoff is collected and returned to the conveyance system, or it can also be partially or fully exfiltrated into the surrounding soil in areas with porous soils. A schematic of a surface sand filter is shown in Figure TSS-03-01.

Because they have few site constraints beside head requirements, sand filters can be used on development sites where the use of other structural controls may be precluded. However, sand filter systems can be relatively expensive to construct and install and they have high maintenance requirements.

A design variant, the *underground sand filter*, is intended primarily for extremely space limited and high density areas and is thus considered a limited application structural control. See TSS-08 for more details. Another design variant is the *perimeter sand filter*, which is an enclosed filter system typically constructed just below grade in a vault along the edge of an impervious area such as a parking lot. See TSS-09 for information on the perimeter sand filter.

In surface sand filter systems, stormwater pollutants are removed through a combination of gravitational settling, filtration, and adsorption. The filtration process effectively traps suspended solids and particulates. As solids are trapped in the sand bed, some reduction of associated pollutants such as biochemical oxygen demand (BOD), fecal coliform bacteria, and other pollutants may be achieved.

## TSS – 03 SECTION 2: SITE AND DESIGN CONSIDERATIONS

### Location and Siting

1. Surface sand filters should have a contributing drainage area of 10 acres or less.
2. Surface sand filter systems are generally applied to land uses with a high percentage of impervious surfaces. Sites with less than 50% imperviousness or with high clay/silt sediment loads must not use sand filters without adequate pretreatment because the sediment causes clogging and failure of the filter bed. Any disturbed areas within the sand filter facility drainage area should be identified and stabilized. Filtration controls should only be constructed after the construction site is stabilized.
3. Surface sand filters are used in an off-line configuration where the water quality volume ( $WQ_v$ ) is diverted to the filter facility. Stormwater flows greater than the  $WQ_v$  are diverted to other controls or downstream using a diversion structure or flow splitter.
4. Sand filter systems are designed for intermittent flow and must be allowed to drain and aerate between rainfall events. They should not be used on sites with a continuous flow from groundwater, sump pumps, or other sources.

### General Design

5. A surface sand filter facility consists of a two-chamber open-air structure, which is located at ground-level. The first chamber is the sediment forebay (sedimentation chamber) while the second chamber houses the sand filter bed. Flow enters the forebay chamber where settling of larger sediment particles occurs.





Discharge from the forebay chamber flows through a perforated standpipe into the sand bed chamber. The flow is then uniformly distributed across the sand bed chamber via distribution vault or weir. After passing through the filter bed, runoff is collected by a perforated pipe and gravel underdrain system. Figure 3.1 provides plan view and profile schematics of a surface sand filter.

#### Physical Specifications/Geometry

6. The entire treatment system (including the forebay) must temporarily hold the  $WQ_v$  prior to filtration. Table 3.1 presents the design parameters and values for the perimeter sand filter. Figure 3.2 illustrates these design parameters.
7. The forebay chamber must be sized to at least 50% of the computed  $WQ_v$ , hold this volume for 24 hours, and have a length-to-width ratio of at least 2:1. Inlet and outlet structures should be located at opposite ends of the chamber.
8. The filter area is sized based on the principles of Darcy's Law. A coefficient of permeability ( $k$ ) of 3.5 ft./day for sand should be used. The filter bed is typically designed to completely drain in 24 hours or fewer.
9. The filter media consists of an 18 to 24 inch layer of clean washed medium sand (meeting ASTM C-33 concrete sand) on top of the underdrain system. Permeable filter fabric is placed both above and below the sand bed to prevent clogging of the sand filter and the underdrain system. Figure 4.3 illustrates a typical media cross section.
10. The filter bed is equipped with a 6-inch perforated pipe (ASTM Schedule 40) underdrain in a gravel layer. The underdrain must have a minimum grade of 1/8-inch per foot (1% slope). Holes should be 3/8-inch diameter and spaced approximately 6 inches on center. Gravel should be clean washed aggregate with a maximum diameter of 3.5 inches and a minimum diameter of 1.5 inches with a void space of about 30%. Do not use aggregate contaminated with soil.
11. The structure of the surface sand filter may be constructed of impermeable media such as concrete, or through the use of excavations and earthen embankments. When constructed with earthen walls/embankments, filter fabric should be used to line the bottom and side slopes of the structures before installation of the underdrain system and filter media. The structure should include an access ramp at 4:1 (H:V) or less for maintenance.

#### Pretreatment/Inlets

12. Pretreatment of runoff in a sand filter system is provided by the forebay chamber.
13. Inlets to surface sand filters are to be provided with energy dissipaters. Exit velocities from the forebay chamber must be nonerosive.
14. Figure 3.4 shows a typical inlet pipe from the forebay to the sand bed chamber where the flow is then evenly distributed across the filtration area.

#### Outlet Structures

15. Outlet pipe is to be provided from the underdrain system to the facility discharge. Due to the slow rate of filtration, outlet protection is generally unnecessary (except for emergency overflows and spillways).

#### 16. Emergency Spillway

17. Surface sand filters are off-line devices and the emergency spillway is provided in case diversion structure fails. The spillway prevents filter water levels from overtopping the embankment and causing structural damage. The emergency spillway should be located so that downstream buildings and structures will not be impacted by spillway discharges.



### 18. Maintenance Access

Adequate access through maintenance easements must be provided for all sand filter systems for inspection and maintenance, including the appropriate equipment and vehicles. Facility designs must enable maintenance personnel to easily replace the upper layers of the filter media. Maintenance access ramps at a 4:1 slope or flatter must be provided.

### Safety Features

19. Surface sand filter facilities can be fenced to prevent unauthorized access.

**Table TSS-03-01. Surface Sand Filter Design Parameters**

Parameter Description	Parameter	Parameter Value
Total Temporary Volume in Forebay and Sand Bed Chamber	$WQ_v$	$WQ_v$ ; See Design Step #1
Approximate Temporary Sand Bed Volume <sup>1</sup>	$V_{ST}$	$(0.5) WQ_v$
Minimum Sand Bed Thickness	$T_s$	18 inches
Sand Bed Design Porosity	$n$	0.3
Sand Bed Design Permeability	$k$	3.5 feet/day
Sand Bed Design Drain Time	$t_d$	1.5 days, 36 hours max
Minimum Sand Bed Chamber Area	$A_s$	See Design Step #6
Approximate Temporary Forebay Volume <sup>2</sup>	$V_{FT}$	$(0.5) WQ_v$
Minimum Forebay Surface Area	$A_f$	$(0.05) WQ_v$
Maximum Temporary Sand Bed Depth <sup>3</sup>	$D_{ST}$	See Design Step #3
Minimum Temporary Forebay Depth	$D_{FT}$	2 feet
Overall Minimum Length to Width Ratio	$L/W$	2

1. Includes temporary storage volume in sand.
2. Includes temporary storage volume in sand.
3. Excludes storage volume in forebay permanent pool.
4. Measured from top of sand bed.

(Adapted from the New Jersey Stormwater Best Management Practices Manual)

## TSS – 03 SECTION 3: AS-BUILT CERTIFICATION

An as-built certification conducted by a registered Professional Engineer must be performed and submitted to the Program. The as-built certification verifies that the BMP was installed as designed and approved.

## TSS – 03 SECTION 4: INSPECTION AND MAINTENANCE

Each BMP must have a Hamilton County Water Quality Stormwater Management Facility I&M Storm Water Management Facilities Agreement submitted for approval and maintained and updated by the BMP owner. The



Stormwater Management Facilities I&M Agreement must be completed and submitted to the Program with the Land Disturbance permit application. The Stormwater Management Facilities I&M Agreement is for the use of the BMP owner in performing routine inspections. The developer/owner is responsible for the cost of maintenance and annual inspections. The BMP owner must maintain and update the BMP inspections and maintenance plan. At a minimum, the inspections and maintenance plan must address:

- ❖ Monitor water level in sand filter chamber.
- ❖ Sedimentation chamber should be cleaned out when the sediment depth reaches 6 inches.
- ❖ Remove accumulated oil and floatables in sedimentation chamber.
- ❖ Replace filter media when temporary pool is maintained for 40 hours following design storm (FHWA).

## TSS – 03 SECTION 5: DESIGN PROCEDURES

### Step 1. Compute the Water Quality Volume.

Calculate the Water Quality Volume ( $WQ_v$ ), which must be temporarily stored within the perimeter sand filter's entire treatment system.

$$\text{Equation TSS-03-01} \\ WQ_v = 1.1 \times P \times R_v \times A/12$$

Where:

$WQ_v$  = water quality treatment volume, ac-ft.

$P$  = 1.0 inch

$R_v$  = volumetric runoff coefficient (See Section 1 Chapter 3.1)

$A$  = contributing drainage area, acres

### Step 2. Determine approximate required volumes of the forebay and sand bed.

Each should be equal to approximately 0.5  $WQ_v$ , as shown in Table TSS-03-01.

### Step 3. Determine approximate temporary depths in sand bed ( $D_{ST}$ ) and forebay ( $D_{FT}$ ) for the $WQ_v$ .

The estimate will depend on and be based on analysis of site conditions including the difference between the invert elevation of the downstream conveyance system and the maximum ground elevation at filter facility. Make sure to include the minimum sand bed thickness ( $T_{HS}$ ) into the consideration for these temporary depths. Note that the maximum temporary depth in the sand bed zone ( $D_{ST}$ ) is measured from the top of the sand bed, while the maximum temporary forebay depth ( $D_{FT}$ ) is measured the bottom of the forebay.

### Step 4. Compute minimum forebay surface area ( $A_F$ ).

The minimum surface area is

$$\text{Equation TSS-03-02} \\ A_F = 0.05 (WQ_v)$$

Where:

$A_F$  = forebay area

0.05 = a multiplier in units per area of volume ( $L^2/L^3$ )





**Step 5. Compute total temporary storage volume in the forebay ( $V_{FT}$ ).**

From the maximum temporary depth in the forebay ( $D_{FT}$ ) from Step 3 and the minimum forebay area ( $A_F$ ) from Step 4, compute the total temporary storage volume in the forebay ( $V_{FT}$ ). *Compare* this volume with the approximate required forebay volume computed in Step 2. *Adjust* the maximum temporary forebay depth ( $D_{FT}$ ) and/or forebay area ( $A_F$ ) as necessary to achieve a total temporary forebay storage volume ( $V_{FT}$ ) as close as practical to the required forebay volume from Step 2. While adjusting the forebay surface area ( $A_F$ ) by varying its length and width, remember that the forebay will be located immediately adjacent to the sand bed zone and that the minimum overall length to width ratio of the combined zone is two to one.

**Step 6. Compute sand bed chamber area ( $A_S$ ).**

The filter area is sized using the following equation (based on Darcy's Law):

**Equation TSS-03-03**

$$A_S = (WQ_v) (T_s / [(k) (D_{ST}/2 + T_s) (T_d)])$$

Where:

- $A_S$  = Sand Bed Surface Area (in square feet)
- $T_s$  = Thickness of Sand in Sand Bed  
(typically 18 inches, no more than 24 inches)
- $k$  = Coefficient of permeability of filter media (ft./day)  
(use 3.5 ft./day for sand)
- $D_{ST}$  = Maximum Temporary Sand Bed Depth (ft.)
- $t_d$  = Sand Bed Design Drain Time  
(1.5 days or 36 hours is recommended maximum)

See the Physical Specifications/Geometry section of the *Site and Design Considerations* for filter media specifications.

**Step 7. Compute total temporary storage volume in sand bed.**

**Equation TSS-03-04**

$$V_{ST} = (A_S)(D_{ST}) + (A_S)(T_s)(n)$$

Where:

- $V_{ST}$  = Temporary Sand Bed Storage Volume (in cubic feet)
- $A_S$  = Sand Bed Surface Area (in square feet)
- $D_{ST}$  = Maximum Temporary Sand Bed Depth (ft.)
- $T_s$  = Thickness of Sand in Sand Bed, recommended 18 inches (in feet)
- $n$  = Sand Bed Design Porosity, recommended 0.3

**Step 8. Compare and adjust areas and volumes to achieve storage of  $WQ_v$  within the entire facility.**

Compare the total temporary sand bed storage volume ( $V_{ST}$ ) with the approximate required sand bed zone volume computed in Step 2. As shown on Table 3.1, this temporary sand bed storage volume should be approximately one half of the stormwater quality design storm runoff volume ( $WQ_v$ ). In addition, add the total temporary sand bed volume ( $V_{ST}$ ) to the total temporary forebay storage volume ( $V_{FT}$ ) to determine the total temporary storage volume in the sand filter. As shown in Table 3.1, this total temporary storage volume must



equal the stormwater quality design storm runoff volume ( $WQ_v$ ). Adjust the maximum temporary sand bed depth ( $D_{ST}$ ) and/or sand bed area ( $A_s$ ) as necessary to achieve a total temporary sand bed storage volume ( $V_{ST}$ ) as close as practical to the required sand bed volume from Step 2 and a total filter volume equal to  $WQ_v$ . Remember, while adjusting width and length that forebay will be located immediately adjacent to the sand bed zone and that the minimum overall length to width ratio of the combined zone is two to one.

**Step 9. Design flow diversion structure.**

A flow regulator (or flow splitter diversion structure) should be supplied to divert the  $WQ_v$  to the sand filter.

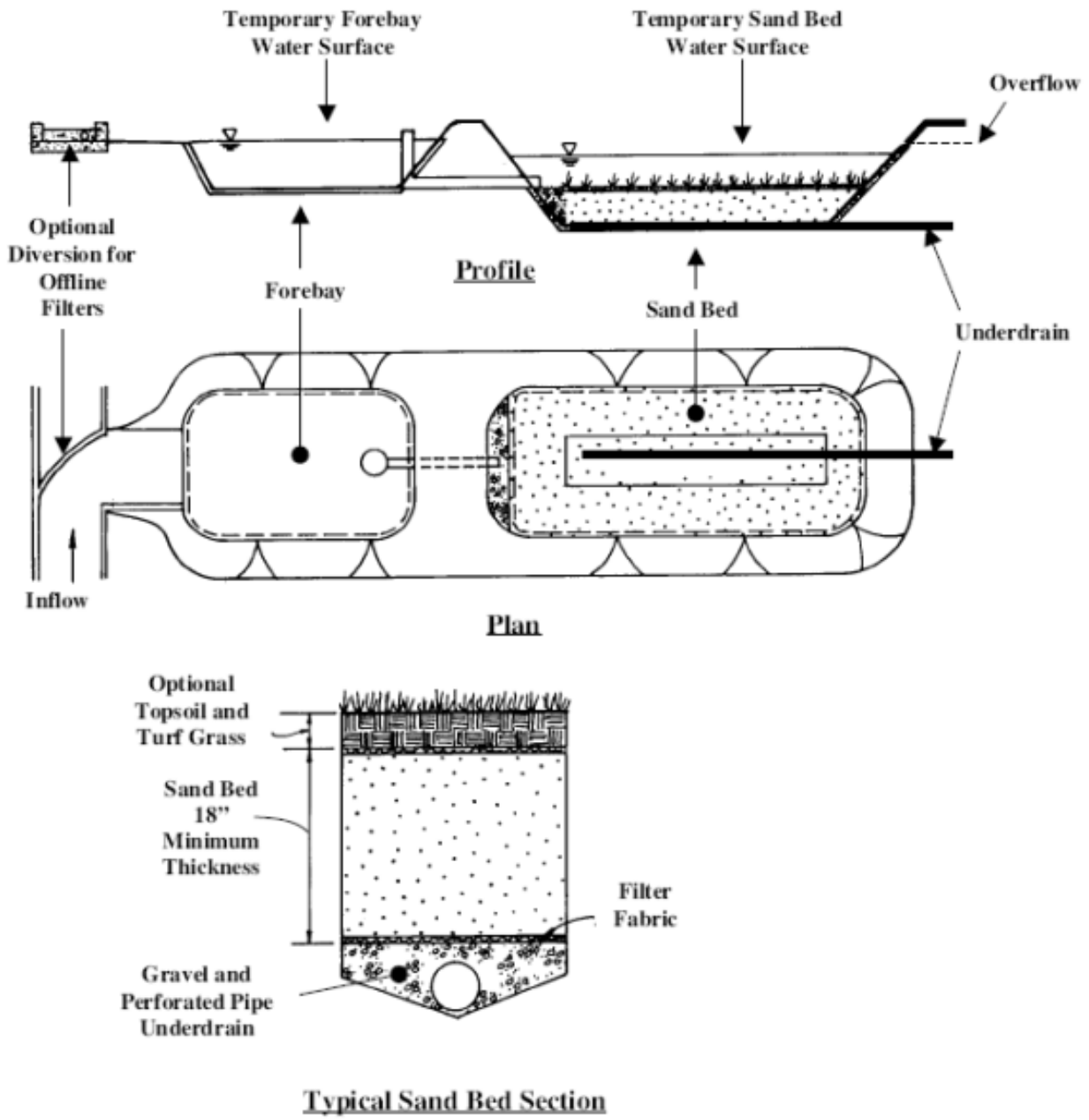
Size low flow orifice, weir, or other device to bypass the 100-year flood.

**Step 10. Design inlets, underdrain system, overflow weirs, and outlet structures.**

See *Site and Design Considerations* for more information on underdrain specifications and outlet structures. TSS-01 provides more information on sizing orifices, weirs, and outlets.

**Step 11. Design emergency overflow.**

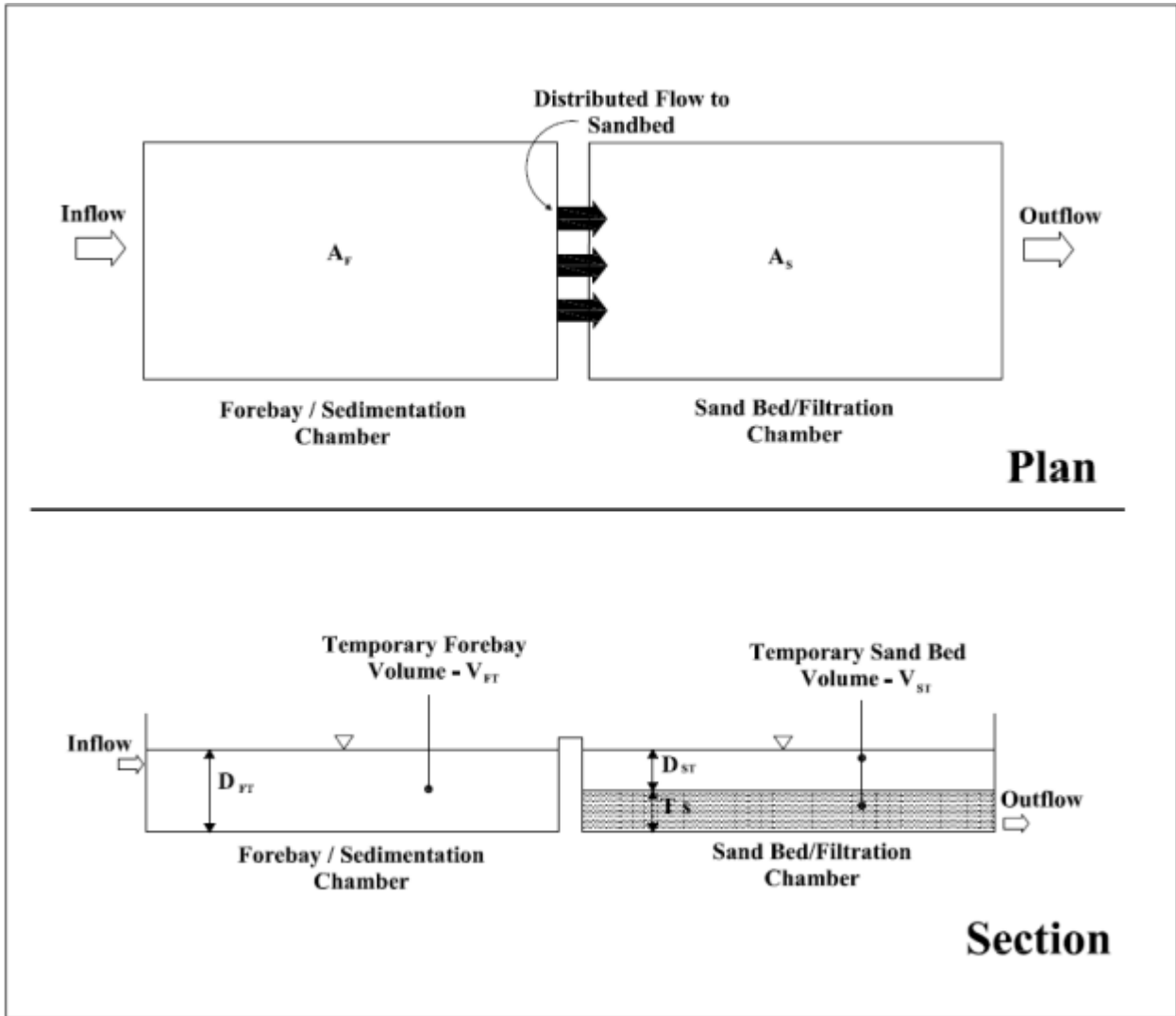
An overflow must be provided in case of a failure in the diversion structure. Non-erosive velocities need to be ensured at the outlet point.



(Source: New Jersey Stormwater Best Management Practices Manual, 2003)

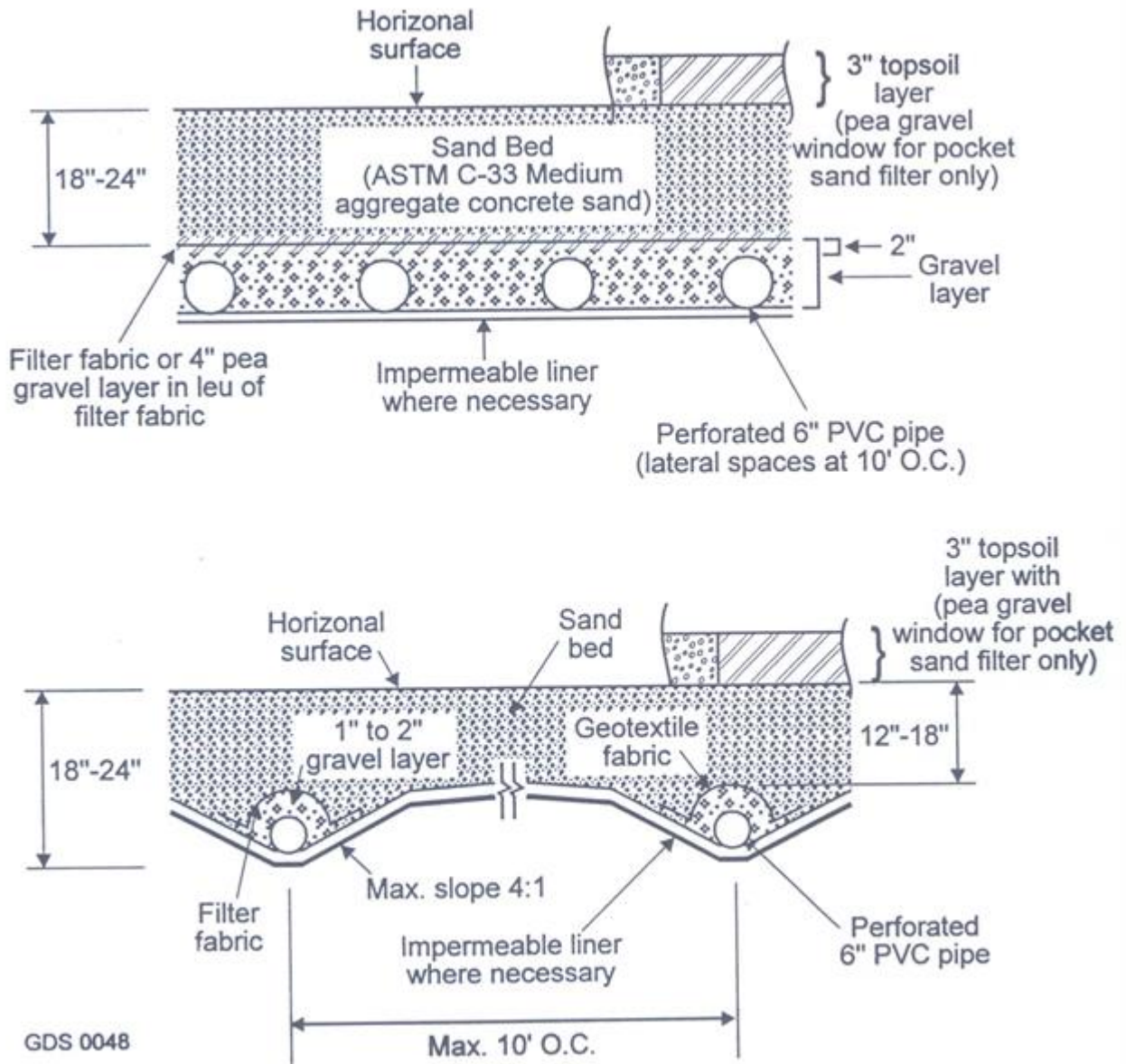
**Figure TSS-03-01 Surface Sand Filter Schematic**





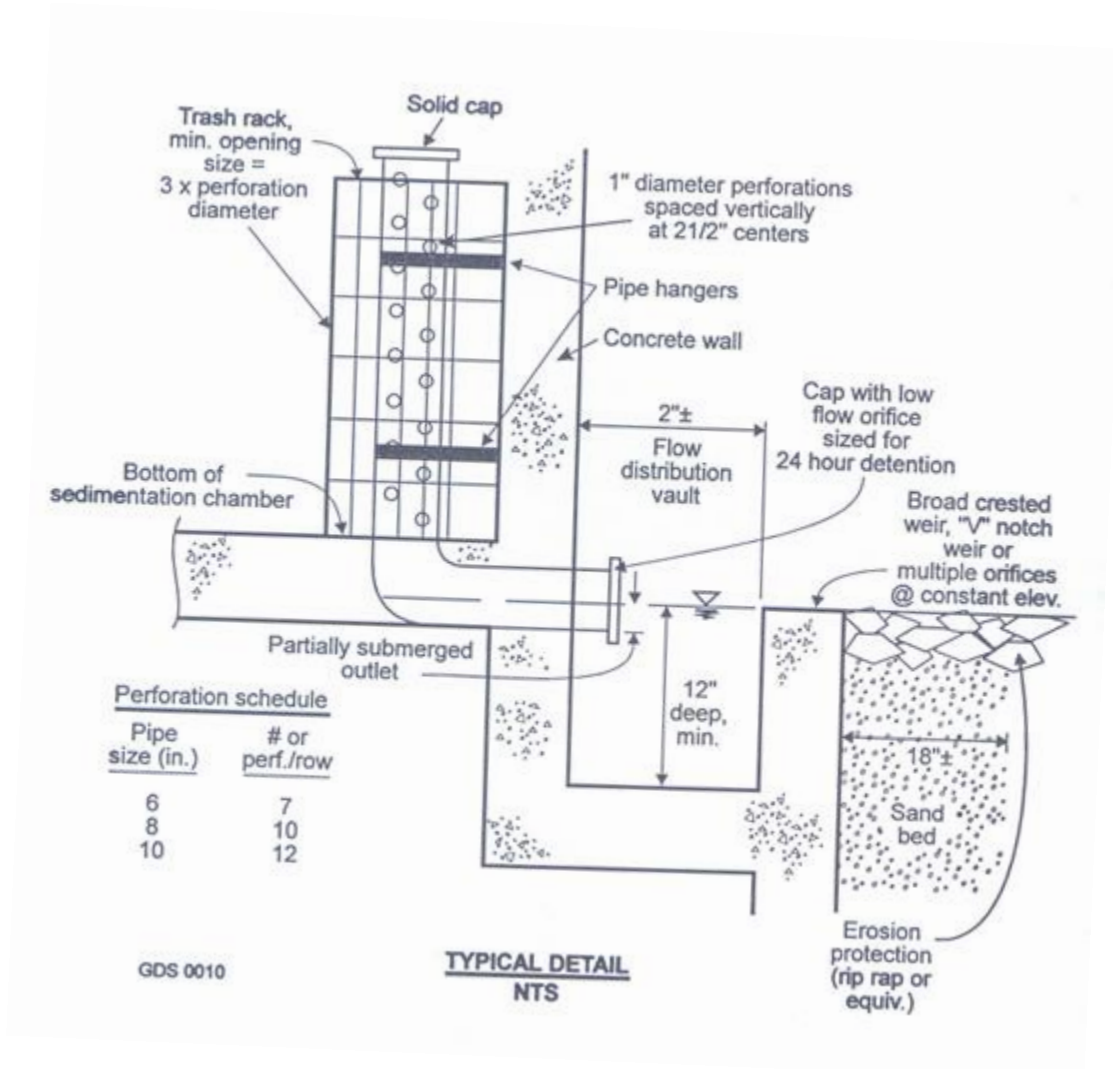
(Source: New Jersey Stormwater Best Management Practices Manual, 2003)

Figure TSS-03-02 Schematic of Surface Sand Filter Showing Design Parameter



(Source: Clayton and Schueler, 1996)

Figure TSS-03-03 Typical Sand Filter Media Cross Sections



(Source: Claytor and Schueler, 1996)

**Figure TSS-03-04 Surface Sand Filter Perforated Stand-Pipe**





## TSS – 03 SECTION 6: REFERENCES

ARC, 2001. Georgia Stormwater Management Manual Volume 2 Technical Handbook.

Center for Watershed Protection, Accessed July 2005. Stormwater Manager’s Resource Center. [Manual Builder.](http://www.stormwatercenter.net)  
[www.stormwatercenter.net](http://www.stormwatercenter.net).

City of Franklin, Stormwater Management Program, January 2014. *City of Franklin Stormwater Best Management Practices Manual*.

Connecticut Department of Environmental Protection, 2004. Stormwater Quality Manual.

New Jersey Department of Environmental Protection, 2004. Stormwater Best Management Practices Manual.

StormwaterAuthority.com, Accessed January, 2006. “Sand and Organic Filters.” [www.stormwaterauthority.com](http://www.stormwaterauthority.com) .



## Water Quality Swale



## TSS - 04

Hamilton County



Water Quality Program

**Description:** Vegetated open channels that are designed to capture and treat stormwater runoff within dry or wet cells formed by check dams or other methods. Swales can be wet or dry.

### Components:

- Open trapezoidal or parabolic channel sized to store entire  $WQ_v$ . Dry swale infiltrates full  $WQ_v$  and wet swale retains  $WQ_v$ .
- Filter bed of permeable, engineered soils
- Underdrain system for impermeable soils (dry swale only)
- Wet cells created by check dams (wet swale only)
- Level spreaders every 50 feet, if length exceeds 100 feet.

### Advantages/Benefits:

- Stormwater treatment combined with runoff conveyance
- Less expensive than curb and gutter
- Reduces runoff velocity
- Promotes infiltration

### Disadvantages/Limitations:

- Higher maintenance than curb and gutter
- Cannot be used on steep slopes
- High land requirement
- Vector concerns (wet water quality swale)
- Requires  $\approx$  3 feet of head

### Design considerations:

- Longitudinal slopes less than 4%
- Bottom channel width of 2 to 8 feet
- Underlying soils must have good infiltration or must be replaced (dry swale)
- Side slopes of 3:1 or flatter; 4:1 recommended
- Convey the 10-year storm event with minimum 6 inches of freeboard.

### Selection Criteria:



**Water Quality**  
80 % TSS Removal



**Accepts Hotspot**  
**Runoff (impermeable**  
**liner required)**



**Residential**  
**Subdivision**



**High Density /**  
**Ultra Urban Use**

### Maintenance:

- Maintain grass heights
- Remove sediment from forebay and channel
- Remove accumulated trash
- Re-establish plants as needed



**Maintenance**  
**Burden**

L = Low M = Moderate H = High



## TSS – 04 SECTION 1: DESCRIPTION

Water quality swales, also known as “enhanced swales” or vegetated open channels, are channels that capture and treat the water quality volume for a site. They are specifically engineered to perform pollutant removal functions. Water quality swales have specific features that allow them to treat the Water Quality Volume (WQ<sub>v</sub>). Water quality swales are designed with gradual longitudinal slopes that force runoff to slow down, which allow sediment to settle out while limiting channel erosion. Check dams or other mechanisms are installed perpendicular to the flow to further allow sediment to settle out and runoff to infiltrate.

There are two types of water quality swales, dry and wet:

**Dry water quality swales:** The dry swale is a vegetated channel that includes a filtering bed of permeable soils overlying an underdrain system. Dry swales are designed to filter or infiltrate the entire WQ<sub>v</sub> through this filter bed and underdrain system. Dry swales rely primarily on the filtration mechanism to remove stormwater pollutants. *If it can be demonstrated that the swale can infiltrate the WQ<sub>v</sub> within 24 to 48 hours (24 hours is preferred) without an underdrain, the swale may be designed without the underdrain.*

**Wet water quality swale:** The wet swale is a vegetated channel, also called a wetland channel that acts as a shallow wetland system that retains the WQ<sub>v</sub>. The channel supports wetland vegetation in shallow marshy conditions. Usually impermeable or poorly drained soils are necessary to support the sufficient retention of water. Wet swales remove pollutants through sediment settling and biological removal. A wet swale does not require an underdrain.

Enhanced swales can be used in a variety of development types; however, they are primarily applicable to residential and institutional areas of low to moderate density where the impervious cover in the contributing drainage area is relatively low. They can also be used along roads and highways. Dry swales are mainly used in moderate to large lot residential developments, small impervious areas (parking lots and rooftops), and along rural highways. Wet swales tend to be used for highway runoff applications, small parking areas, and in commercial developments as part of a landscaped area. Because of their relatively large land requirement, enhanced swales are generally not used in higher density areas. In addition, wet swales may not be desirable for some residential applications, due to the presence of standing water, which may create nuisance odor or mosquito problems.

The topography and soils of a site will determine the applicability of the use of one of the two enhanced swale designs. Overall, the topography should allow for the design of a swale with sufficient slope and cross-sectional area to maintain nonerosive velocities. The following criteria should be evaluated to ensure the suitability of a water quality swale for meeting stormwater management objectives on a site or development.

## TSS – 04 SECTION 2: SITE AND DESIGN CONSIDERATIONS

The following design and site considerations must be incorporated into the design for a water quality swale:

### Location:

1. Channels must be sited so that the longitudinal slope is less than 4%. *Drop structures*, which disrupt flow by producing a pool of water behind them and a short drop in the surface gradient for water flowing over the





structure, may be used to reduce the velocity of water in areas with greater slopes. Drop structures include check dams.

2. The water quality swale should have a contributing drainage area of five acres or less to prevent problems with distributing flow evenly across the swale.
3. Wet swales may be used where the water table is very high (at or near the surface of the soil) or where the water balance in poorly drained soils will support wetland vegetation.

#### General Design:

4. Both wet and dry water quality swales are designed to treat for water quality, but also to pass larger storms. Runoff enters the channel through a pretreatment forebay. In addition, distributed flow can enter along the sides of the channel after passing through a flow spreader such as a pea gravel diaphragm, level 2 x 12 timbers, or other level spreader along the bank of the channel.
5. Dry water quality swale: consists of an open channel with a filter bed of permeable soils overlaying an underdrain system. Water flows into the channel where it is filtered through the permeable bed. After being filtered, the runoff is conveyed through a perforated pipe and underdrain system to the outlet. A schematic is found in Figure 4.1.
6. Wet water quality swale: consists of an open channel excavated to the water table or to poorly drained soils. Check dams divide the channel into cells. A schematic is found in Figure 4.2.

#### Physical Specifications:

7. Swales can incorporate raised inlets (4 to 6 inches) to allow for the retention of initial runoff volume.
8. Channel slopes of 1% to 2% and no greater than 4% are recommended. If steeper slopes are necessary, 6 to 12 inch drop structures (see #1 above) can be used to limit runoff energy. Energy dissipators must be installed below drop structures and drop structures must be no closer than 50 feet. The depth of the water at the downstream end of the swale must not exceed 18 inches.
9. Both dry and wet water quality swales must have a bottom channel width of 2 to 8 feet. Wider channels may be installed if designed with berms, walls, or a multi-level cross-section that prevent the channel from meandering and eroding.
10. Cross-sections of dry and wet swales are to be parabolic or trapezoidal with moderate slopes of no greater than 3:1. More gentle slopes of 4:1 are recommended.
11. Minimum width should be determined using Manning's equation, with an n of 0.2 to 0.24.
12. Maximum length of the swale shall be 100 feet unless level spreaders are used. Level spreaders shall be placed at least every 50 feet. Maximum length without a level spreader is 80 feet.
13. The maximum ponding depth of the WQ<sub>v</sub> must be no greater than 18 inches at the downstream end of the swale. The average ponding depth should be 12 inches.
14. The maximum velocity should be no more than 0.9 feet per second.

#### Physical Specifications—Dry Swale:

15. Dry swale channels are sized to store and infiltrate the entire water quality volume (WQ<sub>v</sub>) with less than 18 inches of ponding and allow for full filtering through the permeable soil layer. The maximum ponding time is 48 hours, though a 24-hour ponding time is more desirable. Refer to TSS-01 for orifice sizing.
16. The bed of the dry swale consists of a permeable soil layer of at least 30 inches in depth, above a 4-inch diameter perforated pipe (AASHTO Schedule 40) longitudinal underdrain in a 6-inch gravel layer. The soil media should have an infiltration rate of at least 0.5 inches/hour (maximum 0.75 inches/hour) and contain a high level of organic material to facilitate pollutant removal. A permeable filter fabric is placed between the gravel layer and the overlying soil.



**TableTSS-04-01. Infiltration Rates of Common Soil Types**

Common Soil Types	Infiltration Rates (inches/hour)
<b>Coarse Sand</b>	<b>¾ to 2</b>
<b>Fine Sand</b>	<b>½ to 1</b>
<b>Fine Sandy Loam</b>	<b>1/3 to ¾</b>
<b>Silt Loam</b>	<b>¼ to 4/10</b>
<b>Clay Loam</b>	<b>1/10 to ¼</b>

(Source: NRCS, USDA [www.soils.usda.gov](http://www.soils.usda.gov))

- The channel and underdrain excavation should be limited to the width and depth specified in the design. The bottom of the excavated trench shall not be loaded in a way that causes soil compaction, and scarified prior to placement of gravel and permeable soil. The sides of the channel shall be trimmed of all large roots. The sidewalls shall be uniform with no voids and scarified prior to backfilling.

**Physical Specifications—Wet Swale:**

- Wet swale channels are sized to retain the entire water quality volume (WQ<sub>v</sub>) with less than 18 inches of ponding at the maximum depth point.
- Check dams can be used to achieve multiple wetland cells. V-notch weirs in the check dams can be utilized to direct low flow volumes.

**Pretreatment/Inlets**

- Inlets to enhanced swales must be provided with energy dissipators such as riprap.
- Pretreatment of runoff in both a dry and wet swale system is typically provided by a sediment forebay located at the inlet. The pretreatment volume should be equal to 0.1 inches per impervious acre. This storage is usually obtained by providing check dams at pipe inlets and/or driveway crossings.
- Enhanced swale systems that receive direct concentrated runoff may have a 6-inch drop to a flow spreader at the upstream end of the control.
- A flow spreader and gentle side slopes should be provided along the top of channels to provide pretreatment for lateral sheet flows.

**Outlet Structures**

- Dry water quality swale* underdrain system must discharge to the storm drainage infrastructure or a stable outfall.
- Wet water quality swales* must have outlet protection at any outlet so that scour and downstream erosion do not occur.

**Other Considerations**

- Water quality swales must be designed to safely pass flows that exceed the design storm flows.
- Maintenance access must be provided for all swales.
- Landscaping must specify grass species and/or wetland plants that will thrive under the hydric and soils conditions at the particular site.



## TSS – 04 SECTION 3: AS-BUILT CERTIFICATION

After the water quality swale has been constructed, the developer must have an as-built certification of the swale prepared by a registered Professional Engineer and submit it to the Program. The as-built certification verifies that the BMP was installed as designed and approved.

The following components must be addressed in the as-built certification:

- ❖ Appropriate underdrain system for dry swales.
- ❖ Correctly sized treatment volume.
- ❖ Poor soils or groundwater table interface for wet swales.
- ❖ Adequate vegetation in place.
- ❖ Overflow system in place for high flows.

## TSS – 04 SECTION 4: MAINTENANCE

Each BMP must have a Hamilton County Water Quality Stormwater Management Facility I&M Storm Water Management Facilities Agreement submitted for approval and maintained and updated by the BMP owner. The Stormwater Management Facilities I&M Agreement must be completed and submitted to the Program with the Land Disturbance permit application. The Stormwater Management Facilities I&M Agreement is for the use of the BMP owner in performing routine inspections. The developer/owner is responsible for the cost of maintenance and annual inspections. The BMP owner must maintain and update the BMP inspections and maintenance plan. At a minimum, the inspections and maintenance plan must address:

- ❖ Inspection and repair/replacement of treatment components.
- ❖ Maintain vegetation at heights of 8 inches or less to prevent thinning of vegetative cover, which lessens swale effectiveness.
- ❖ Removal of debris or dead vegetation.

## TSS – 04 SECTION 5: LANDSCAPING

*Dry Swale:* Turf grass species appropriate for Hamilton County conditions should be used for dry swale vegetation.

*Wet Swale:* Emergent vegetation should be planted or wetland soils can be spread on the swale bottom for seeding. Where wetland swales do not intercept the groundwater table, a water balance calculation should be performed to ensure that the swale has a water budget adequate to support wetland species. The water balance calculation is found in the stormwater Constructed Wetland BMP, TSS-02.

## TSS – 04 SECTION 6: DESIGN PROCEDURES

**Step 1. Compute the Water Quality Volume.**





Calculate the Water Quality Volume ( $WQ_v$ ), which is the volume that must be stored in the swale.

**Equation TSS-04-01**  
 **$WQ_v = 1.1 \times P \times R_v \times A/12$**

Where:

$WQ_v$  = water quality treatment volume, ac-ft.

P = 1.0 inch

$R_v$  = volumetric runoff coefficient (See Section 1 Chapter 3.1)

A = contributing drainage area, acres

**Step 2. Determine if the development site and conditions are appropriate for the use of an enhanced swale system (dry or wet swale).**

See the *Site and Design considerations*, above.

**Step 3. Determine pretreatment volume.**

The forebay should be sized to contain 0.1 inches per impervious acre of contributing drainage. The forebay storage volume ( $F_v$ ) counts toward the total  $WQ_v$  requirement and may be subtracted from the  $WQ_v$  for subsequent calculations.

**Equation TSS-04-02**  
 **$F_v = 0.1 \text{ inches} \times A_i \text{ acres} \times .0833$**

Where:

$F_v$  = Forebay volume (ac-ft.)

$A_i$  = Impervious area of drainage basin, acres

0.0833 = conversion factor of acre inches to acre feet

Often, it is more manageable to work with forebay volumes in cubic feet rather than acre feet, because they are small volumes. To convert  $F_v$  in acre feet to cubic feet, multiply  $F_v$  by 43560 square feet.

**Step 4. Determine swale dimensions.**

Size bottom width, depth, length, and slope necessary to store  $WQ_v$  with less than 18 inches of ponding at the downstream end.

Channel slope cannot exceed 4% (1% to 2% recommended). For more steeply sloped areas, swale must be “stepped” with check dams or similar structures to maintain slope.

Bottom width should range from 2 to 8 feet

Length to width ratio of 5:1 is suggested.

Ensure that side slopes are no greater than 3:1 (4:1 recommended)

See *Site and Design Considerations*, above.

**Step 5. Compute number of check dams or similar structures required to detain  $WQ_v$ .**

**Step 6. Calculate drawdown time in the swale.**



*Dry Swale:* Planting soil, 30 inches, should pass a maximum rate of 1.5 feet/day and must completely filter  $WQ_v$  in 48 hours.

*Wet Swale:* Must hold  $WQ_v$ .

**Step 7. Check 2-year velocity erosion potential and provide 6 inches of freeboard above 10-year storm.**

**Step 8. Design low flow orifice at downstream headwalls and checkdams.**

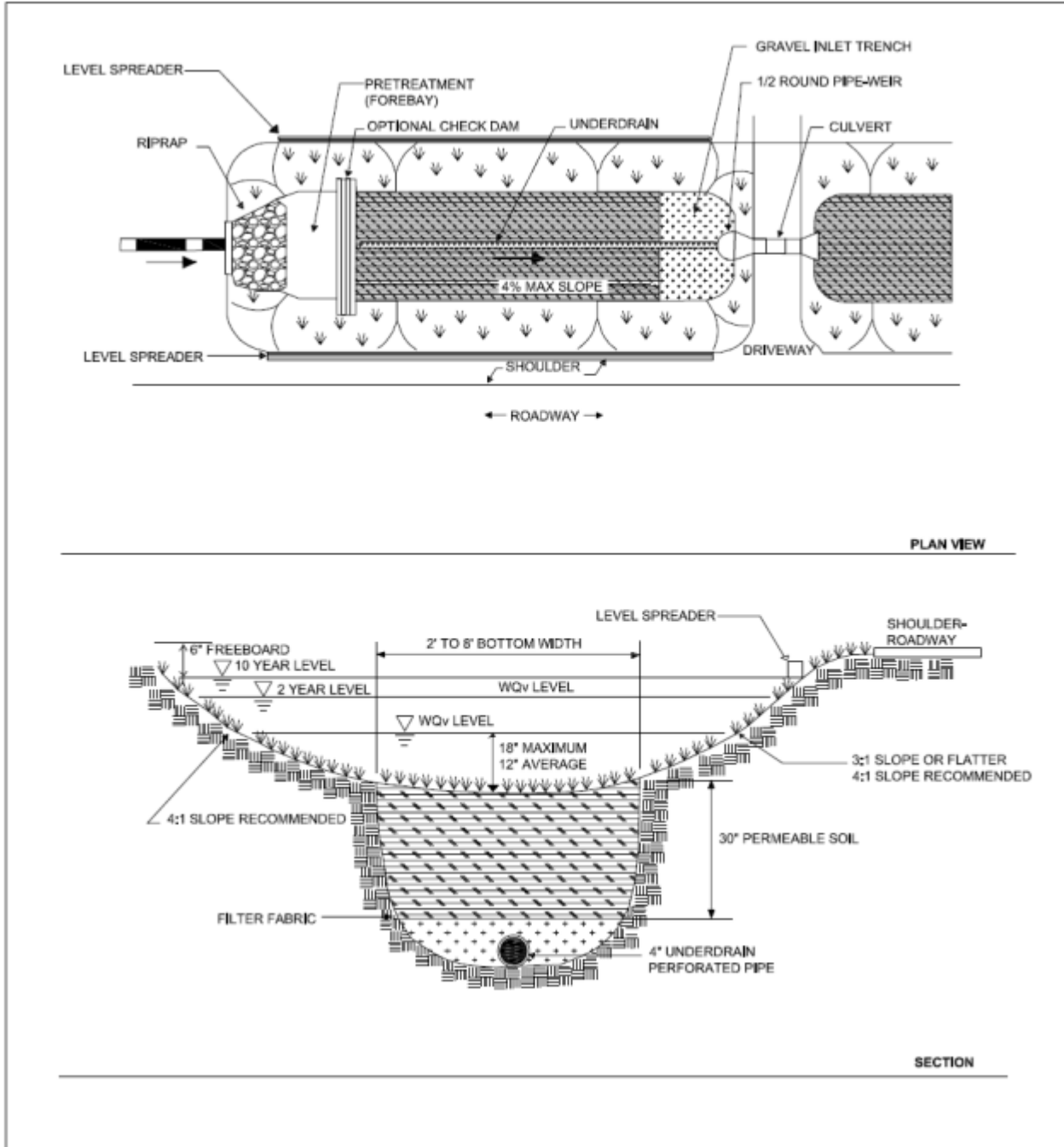
Design orifice to pass  $WQ_v$  in six hours. See TSS-01 Stormwater Ponds for information on orifice sizing.

**Step 9. Design inlets, sediment forebays and underdrain system (dry swale).**

See *Site and Design Considerations*, above.

**Step 10. Prepare Vegetation and Landscaping Plan.**

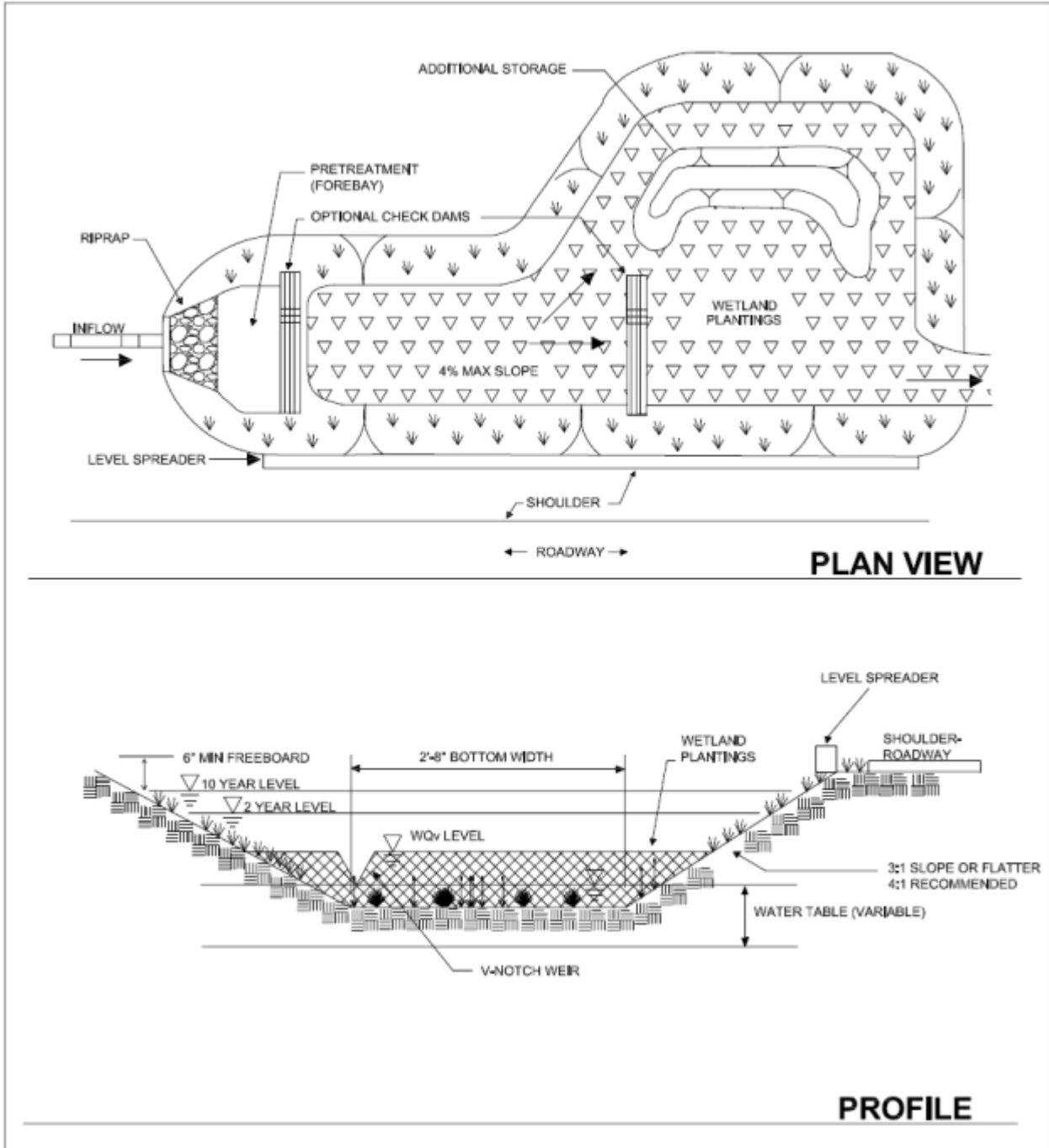
A landscaping plan for a dry or wet swale should indicate how the enhanced swale system will be stabilized and established with vegetation.



(Adapted from the Center for Watershed Protection)

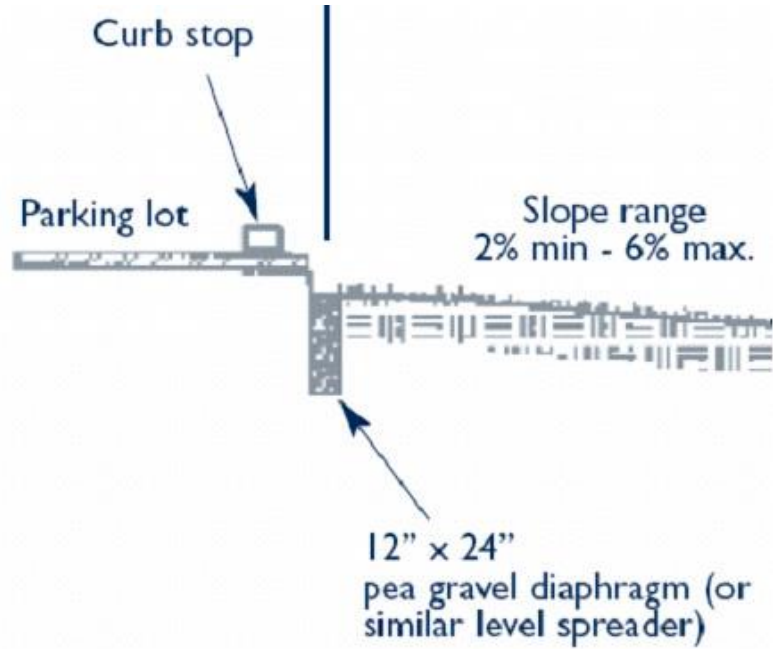
**Figure TSS-04-01 Dry Water Quality Swale**



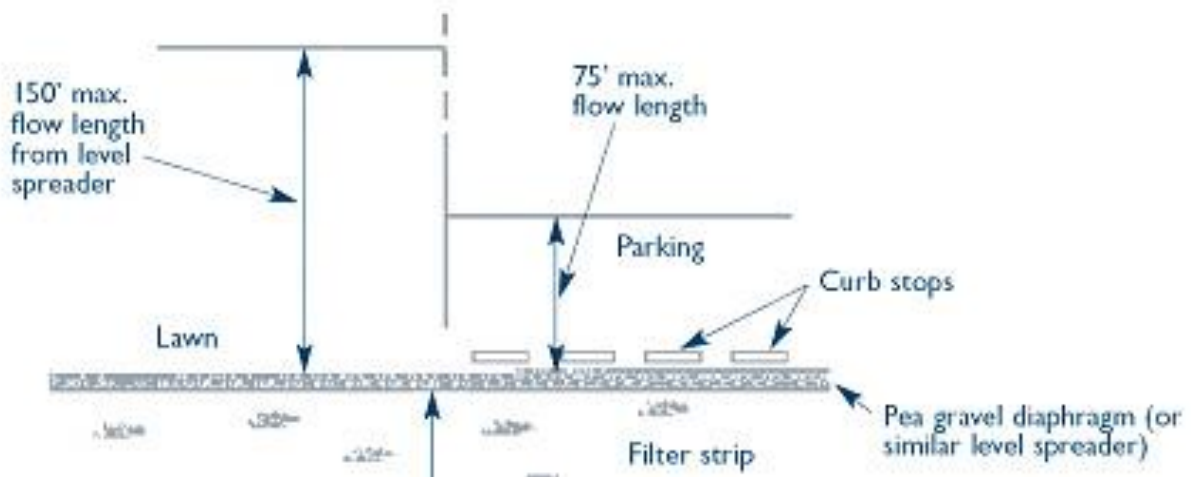


(Adapted from the Center for Watershed Protection)

Figure TSS-04-02 Wet Water Quality Swale



PLAN VIEW



PROFILE

(Source: Connecticut Stormwater Management Manual)

**Figure TSS-04-03 Example of Level Spreader  
 (for Swales Receiving Directly Connected Runoff)**



## TSS – 04 SECTION 7: REFERENCES

ARC, 2001. Georgia Stormwater Management Manual Volume 2 Technical Handbook.

Center for Watershed Protection, Accessed July 2005. Stormwater Manager's Resource Center. Manual Builder. [www.stormwatercenter.net](http://www.stormwatercenter.net).

CDM, 2000. Metropolitan Nashville and Davidson County Stormwater Management Manual Volume 4 Best Management Practices.

City of Franklin, Stormwater Management Program, January 2014. *City of Franklin Stormwater Best Management Practices Manual*.

Connecticut Department of Environmental Protection, 2004. Stormwater Quality Manual.

Federal Highway Administration (FHWA), United States Department of Transportation. Stormwater Best Management Practices in an Ultra-Urban Setting: Selection and Monitoring. Accessed January 2006. <http://www.fhwa.dot.gov/environment/ultraurb/index.htm>

Natural Resources Conservation Service (NRCS), United States Department of Agriculture, [www.soils.gov](http://www.soils.gov).





## Dry Pond



## TSS - 05

Hamilton County



Water Quality Program

**Description:** A surface storage basin or facility designed to provide water quantity control and limited water quality benefits through detention and/or extended detention of stormwater runoff.

### Components:

- Pool area –fills during a storm and releases water slowly through bottom outlet
- Forebay – settles out larger sediments in an area where sediment removal (maintenance) will be easier
- Spillway system – provides outlet for stormwater runoff when large storm events occur

### Advantages/Benefits:

- Typically less costly than stormwater (wet) ponds for equivalent flood storage, as less excavation is required
- Provides recreational and other open space opportunities between storm runoff events

### Disadvantages/Limitations:

- Controls for stormwater quantity—not intended to provide for total water quality treatment; assumed to achieve 60% TSS removal
- Must be used in conjunction with other water quality controls
- Tends to re-suspend sediment

### Design considerations:

- Applicable for drainage areas up to 75 acres
- Drawdown of 24 to 48 hours
- Shallow pond with large surface area performs better than deep pond of same volume
- Assumed to provide 60% TSS removal

### Selection Criteria:

- Water Quality  
80 % TSS Removal
- Accepts Hotspot  
Runoff
- Residential
- Subdivision  
High Density /  
Ultra Urban Use

### Maintenance:

- Remove debris from basin surface
- Remove sediment buildup
- Repair and revegetate eroded areas.
- Perform structural repairs to inlet and outlets.
- Mow unwanted vegetation

L Maintenance Burden

L = Low M = Moderate H = High



## TSS – 05 SECTION 1: DESCRIPTION

Dry extended detention (ED) basins, as shown in Figure 5.1, are surface facilities intended to provide for the temporary storage of stormwater runoff to reduce downstream water quantity impacts. These facilities temporarily detain stormwater runoff, releasing the flow over a period of time. They are designed to completely drain following a storm event and are normally dry between rain events. For the purposes of this application, dry detention and dry extended detention are considered the same treatment.

Dry detention basins, when used for flow attenuation, can be designed to control the 2-year through 10-year storm events as required by the Program.

Dry detention basins provide limited pollutant removal benefits and are not intended for sole water quality treatment. Detention-only facilities must be used in a treatment train approach with other structural controls that provide treatment of the  $WQ_v$ . This type of facility is assumed to provide 60% TSS removal. While the ponds may be providing peak flow attenuation in addition to water quality treatment (in-line ponds), the other water quality treatment controls in the treatment train must be off-line.

Compatible multi-objective use of dry detention facilities is strongly encouraged.

## TSS – 05 SECTION 2: SITE AND DESIGN CONSIDERATIONS

### Location

1. Dry detention basins are to be located downstream of other structural stormwater controls providing treatment of the water quality volume ( $WQ_v$ ). See Section 2.2.2 for more information on the use of multiple structural controls in a treatment train.
2. The maximum contributing drainage area to be served by a single dry detention basin is 75 acres.

### General Design

3. Dry detention basins can be sized to hold the  $WQ_v$  or, if used for flow attenuation, they can be sized to temporarily store the 2-year through the 10-year storm. Routing calculations must be used to demonstrate that the storage volume is adequate for flow attenuation.
4. Tennessee Safe Dams Act may apply to ponds with storage volumes and embankment heights large enough to fall under the regulation.
5. Vegetated embankments shall be less than 20 feet in height and shall have side slopes no steeper than 3:1 (horizontal to vertical). Riprap-protected embankments shall be no steeper than 2:1. Geotechnical slope stability analysis is recommended for embankments greater than 10 feet in height and is mandatory for embankment slopes steeper than those given above. All embankments must be designed to Tennessee state guidelines for dam safety, as applicable.
6. The maximum depth of the basin should not exceed 10 feet.
7. Areas above the normal high water elevations of the detention facility (that is, the largest event for which the facility is sized) should be sloped toward the basin to allow drainage and to prevent standing water. Careful finish grading is required to avoid creation of upland surface depressions that may retain runoff. A low flow or pilot channel across the facility bottom from the inlet to the outlet (often constructed with riprap) is recommended to convey low flows and prevent standing water conditions.
8. Adequate maintenance access must be provided for all dry basins.



### Inlet and Outlet Structures

9. Inflow channels are to be stabilized with flared riprap aprons, or the equivalent. A sediment forebay sized to 0.1 inches per impervious acre of contributing drainage should be provided for dry detention basins.
10. For a dry detention basin used for flow attenuation, the outlet structure is sized for 10-year peak flow control (based upon hydrologic routing calculations) and can consist of a weir, orifice, outlet pipe, combination outlet, or other acceptable control structure. Small outlets that will be subject to clogging or are difficult to maintain are not acceptable. A low flow orifice capable of releasing the  $WQ_v$  over 24 hours must be provided.
11. Seepage control or anti-seep collars should be provided for all outlet pipes.
12. Riprap, plunge pools or pads, or other energy dissipaters are to be placed at the end of the outlet to prevent scouring and erosion. If the basin discharges to a channel with dry weather flow, care should be taken to minimize tree clearing along the downstream channel, and to reestablish a forested riparian zone in the shortest possible distance.
13. An emergency spillway is to be included in the stormwater pond design to safely pass the 100-year peak flow. The spillway prevents pond water levels from overtopping the embankment and causing structural damage. The emergency spillway must be designed to State of Tennessee dam safety requirements and must be located so that downstream structures will not be affected by spillway discharges.
14. A minimum of one foot of freeboard must be provided, measured from the top of the water surface elevation for the 100-year storm, to the lowest point of the dam embankment not counting the emergency spillway.

## TSS – 05 SECTION 3: AS-BUILT CERTIFICATION

After the pond is constructed, an as-built certification of the pond, performed by a registered Professional Engineer, must be submitted to the Program. The as-built certification verifies that the BMP was installed as designed and approved. The following components must be addressed in the as-built certification:

1. Pretreatment for coarse sediments must be provided.
2. Surrounding drainage areas must be stabilized to prevent sediment from clogging the filter media.
3. Correct ponding depths and infiltration rates must be maintained to prevent killing vegetation.
4. A mechanism for overflow for large storm events must be provided.

## TSS – 05 SECTION 4: MAINTENANCE

Each BMP must have a Hamilton County Water Quality Stormwater Management Facility I&M Storm Water Management Facilities Agreement submitted for approval and maintained and updated by the BMP owner. The Stormwater Management Facilities I&M Agreement must be completed and submitted to the Program with the Land Disturbance permit application. The Stormwater Management Facilities I&M Agreement is for the use of the BMP owner in performing routine inspections. The developer/owner is responsible for the cost of maintenance and annual inspections. The BMP owner must maintain and update the BMP inspections and maintenance plan. At a minimum, the inspections and maintenance plan must address:

- ❖ Inspect and repair/replace treatment components.
- ❖ Perform annual verification of infiltration rates.
- ❖ Remove debris or dead vegetation.





Refer to TSS-01 Stormwater Wet Pond for further information on pond design.

## TSS – 05 SECTION 5: DESIGN PROCEDURES

Step 1. Compute the Water Quality Volume to Receive 60% TSS Credit.

Calculate ( $WQ_v$ ). *If flow attenuation is not required, the pond can be sized for the  $WQ_v$  only.*

**Equation TSS-05-01**

$$WQ_v = 1.1 \times P \times R_v \times A/12$$

Where:

$WQ_v$  = water quality treatment volume, ac-ft

P = 1.0 inch

$R_v$  = volumetric runoff coefficient (See Section 1 Chapter 3.1)

A = contributing drainage area, acres

Step 2. Determine if the development site and conditions are appropriate for the use of a dry pond.

Consider the *Site and Design Considerations* previously in this section. This type of treatment must be used in conjunction with another water quality measure in order to achieve 80% TSS removal.

Step 3. Determine pretreatment volume.

A sediment forebay is sized for each inlet, unless the inlet provides less than 10% of the total design storm inflow to the pond. The forebay should be sized to contain 0.1 inches per impervious acre of contributing drainage and should be 4-6 feet deep. The forebay storage volume counts toward the total  $WQ_v$  requirement and may be subtracted from the  $WQ_v$  for subsequent calculations.

**Equation TSS-05-02**

$$F_v = 0.1 \times A_i \times 3630$$

Where:

$F_v$  = Forebay volume ( $\text{ft}^3$ )

$A_i$  = Impervious area of drainage basin, acres

3630 = conversion factor from Ac/in to cubic feet

Step 4. Size the outlets for storm events.

If the pond is to serve as a multifunctional pond addressing peak flow attenuation, the downstream impacts must be considered for the 2- through 100-year events.

Establish a stage-storage-discharge relationship for the design storms of interest, based upon the downstream analysis.

Refer to TSS-01 Stormwater Wet Pond for more information on design of outlet orifices and weirs.

Step 5. Size the low flow outlet for the water quality volume.

Size low flow orifice using the following equation. If different equation is used or different type of low flow orifice is used, provide supporting calculations.



**Equation TSS-05-03**

$$a = \frac{2A(H - H_o)^{0.5}}{3600CT(2g)^{0.5}}$$

Where:

a = area of orifice (ft<sup>2</sup>)

A = average surface area of the pond (ft<sup>2</sup>)

C = orifice coefficient, 0.66 for thin, 0.80 for materials thicker than orifice diameter

T = drawdown time of pond (hrs.)(must be greater than 24 hours)

g = gravity (32.2 ft./sec<sup>2</sup>)

H = elevation when pond in full (ft.)

H<sub>o</sub>= final elevation when pond is empty (ft.)

Step 6. Design embankment and emergency spillway.

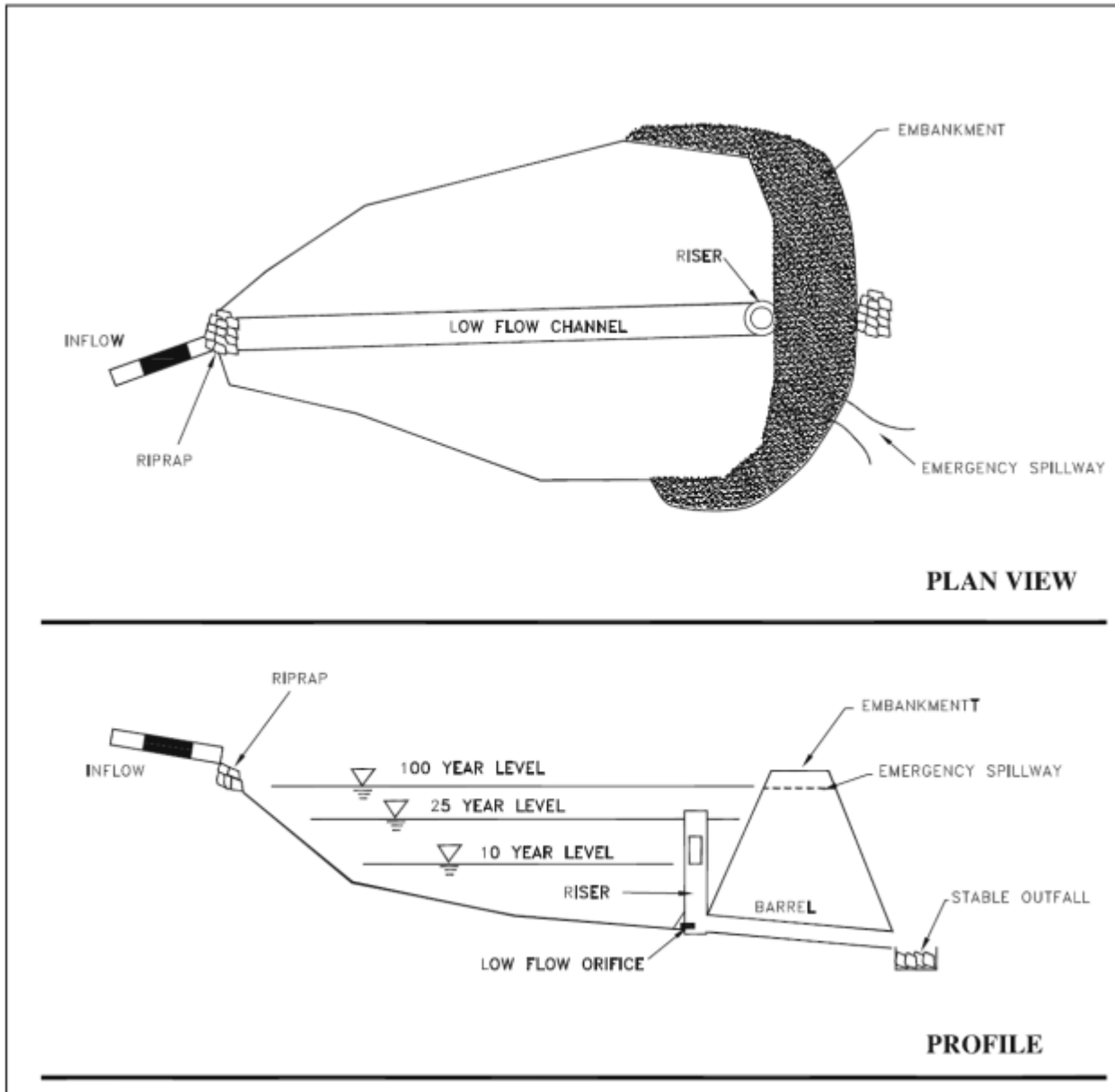
Size emergency spillway for any overtopping of pond in case of rain event in excess of 100-year storm and for instances of malfunction or clogging of primary outlet structure.

Step 7. Investigate potential dam hazard classification.

The design and construction of ponds in Tennessee must follow the requirements of the Safe Dams Act. Contact the Tennessee Department of Environment and Conservation, Division of Water Supply for more information about building dams in Tennessee.

Step 8. Design inlets, sediment forebays, outlet structures, maintenance access and safety features.

See the *Site and Design Considerations* section for information on design.



Note: Storm attenuation levels vary depending on site detention requirements.

*(Adapted from the Center for Watershed Protection)*

**Figure TSS-05-01 Schematic of Dry Extended Detention Basin**





## TSS – 05 SECTION 6: REFERENCES

ARC, 2001. Georgia Stormwater Management Manual Volume 2 Technical Handbook.

CDM, 2000. Metropolitan Nashville and Davidson County Stormwater Management Manual Volume 4 Best Management Practices.

City of Franklin, Stormwater Management Program. January 2014. *City of Franklin Stormwater Best Management Practices Manual*.



## Filter Strip



## TSS - 06

### Hamilton County



### Water Quality Program

**Description:** Uniformly graded section of land that is densely vegetated and is designed to treat runoff through vegetative filtering and infiltration. Water enters the filter strip along its width and runs across the length of the filter strip.

#### Components:

- Vegetation – provides water quality treatment through filtering and plant uptake; vegetation can be grasses or other deep-rooted plants
- Land with gradual slope – minimal slopes allow for some amount of water quality treatment through infiltration
- Level spreader – ensures runoff over the vegetated filter is in sheet flow (shallow, uniform flow length) as opposed to concentrated (channelized) flow

#### Advantages/Benefits:

- High community acceptance in any type of setting
- Easy to maintain once ground cover and/or trees established
- Can be used as pre-treatment for other BMPs, similar to sediment forebay
- Filter strips are easily incorporated into new construction/development designs

#### Disadvantages/Limitations:

- Cannot meet the 80% total suspended solids goal without another BMP in a treatment train. Fifty foot strip is assumed to achieve 50% TSS removal, while 25 foot strip used as a pretreatment control is assumed to achieve 10% TSS removal
- Filter strip and level spreaders have limited drainage areas
- It can be difficult to construct a level lip on level spreaders

#### Design considerations:

- Must have slopes between 2% and 6%
- Must maintain sheet flow across entire filter strip
- Minimum 25 foot flow length; the longer the flow length, the higher the pollutant removal, if sheet flow is maintained.
- Contributing drainage area to filter strip ratio should be around 6:1.

#### Selection Criteria:

- Water Quality  
80% TSS Removal
- Accepts Hotspot  
Runoff
- Residential  
Subdivision
- High Density /  
Ultra Urban Use

#### Maintenance:

- Maintain a dense, healthy stand of grass and other vegetation
- Repair erosion
- Periodic sediment removal
- Revegetate as needed

**L** Maintenance Burden

L = Low M = Moderate H = High



## TSS – 06 SECTION 1: DESCRIPTION

Filter strips are uniformly graded, densely vegetated areas of land that are designed to remove pollutants from runoff through vegetative filtration and infiltration. Filter strips are suited for treating runoff from roads and highways, small parking lots, pervious areas, and roof downspouts. They are also well-suited as the outer zone of a stream buffer and as pretreatment for other structural controls.

The vegetation can be grassed or a combination of grass and woody plants. Pollutant removal efficiencies are based upon a 50-foot long strip. Filter strips with shorter flow lengths are considered to have lower removal efficiencies and should be used as coarse sediment settling areas for other structural controls. Filter strips are and considered to be an integral component of those controls; similar to sediment forebays for stormwater wet ponds (see TSS-01). Uniform sheet flow must be maintained through the filter strip to provide pollutant reduction and to avoid erosion. To obtain sheet flow when discharging runoff from a developed area, a level spreader may be required.

## TSS – 06 SECTION 2: COMPONENTS

Figure TSS-06-01 illustrates a filter strip. Filter strips consist of the following components:

- ❖ Sheet flow spreader that allows flow to enter the filter strip as sheet flow.
- ❖ Uniformly graded area with 2 to 6 percent slopes, with a minimum width of 15 feet, and a minimum length (flow path) of 50 feet for a 50% TSS removal credit and 25 feet for a settling or pretreatment control, with a lesser credit of 10% TSS removal.
- ❖ Dense vegetation that can withstand relatively high velocity flows.
- ❖ Optional berm.

## TSS – 06 SECTION 3: SITE AND DESIGN CONSIDERATIONS

The following design and site considerations must be incorporated into the filter strip design:

1. Filter strips should be used to treat small drainage areas, ordinarily with a maximum of 75 feet for impervious surfaces, and 150 feet for pervious surfaces (CWP, 1996). For longer flow paths, special provision must be made to ensure design flows spread evenly across the filter strip.
2. Flow must enter the filter strip as sheet flow spread out over the width of the strip, generally no deeper than 1 to 2 inches.
3. Filter strips should be integrated into site designs.
4. Filter strips should be constructed outside the natural stream buffer area whenever possible to maintain a more natural buffer along the streambank.
5. Filter strips should be designed for slopes between 2% and 6%. Greater slopes than this would encourage the formation of concentrated flow. Flatter slopes would encourage standing water.
6. Filter strips should not be used on soils that cannot sustain a dense grass cover with high retardance. Designers should choose a grass that can withstand relatively high velocity flows at the entrances, and both wet and dry periods.





7. The filter strip should be at least 15 feet long to provide filtration and contact time for water quality treatment. 25 feet is preferred, though length will normally be dictated by design method. 50 feet is necessary to achieve the 50% TSS removal credit.
8. Both the top and toe of the slope should be as flat as possible to encourage sheet flow and prevent erosion.
9. An effective flow spreader is a pea gravel diaphragm located at the top of the slope (ASTM D 448 size no. 6, 1/8" to 3/8"). The pea gravel diaphragm is a small trench running along the top of the filter strip. It serves two purposes. First, it acts as a pretreatment device, settling out sediment particles before they reach the filter strip. Second, it acts as a level spreader, maintaining sheet flow as runoff flows over the filter strip. Other types of flow spreaders include long timbers, a concrete sill, curb stops, or curb and gutter with "sawteeth" cut into it.
10. Ensure that flows in excess of design flow move across or around the strip without damaging it. Often a bypass channel or overflow spillway with protected channel section is designed to handle higher flows.
11. Maximum discharge loading per foot of filter strip width (perpendicular to flow path) is found using the Manning's equation:

**Equation TSS-06-01**

$$q = \frac{0.00236}{n} Y^{\frac{5}{3}} S^{\frac{1}{2}}$$

Where:

q = discharge per foot of width of filter strip (cfs/ft.)

Y = allowable depth of flow (inches)

S = slope of filter strip (percent)

n = Manning's "n" roughness coefficient

(Use 0.15 for medium grass, 0.25 for dense grass, and 0.35 for very dense Bermuda-type grass)

12. Using q, computed above, The minimum width of a filter strip is:

**Equation TSS-06-02**

$$W_{fMIN} = \frac{Q}{q}$$

Where:

W<sub>fMIN</sub> = minimum filter strip width perpendicular to flow (feet)

Q = Peak discharge (cfs) for the 3 month storm, C \* I \* A

C = Runoff Coefficient

I = 2.45 in/hour

A = contributing drainage area, acres

### Filter Strips without Berm

13. Size filter strip (parallel to flow path) for a contact time of 5 minutes minimum.
14. Equation for filter length is based on the SCS TR-55 travel time equation (SCS, 1986):

**Equation TSS-06-063**

$$L_f = \frac{(T_t)^{1.25} (P_{2-24})^{0.625} (S)^{0.5}}{0.34n}$$

Where:

L<sub>f</sub> = length of filter strip parallel to flow path (25 ft. minimum)



- $T_t$  = travel time through filter strip (5 minutes minimum)
- P2-24 = 2-year, 24-hour rainfall depth (3.68 inches)
- S = slope of filter strip (2-6 percent preferred)
- n = Manning’s “n” roughness coefficient  
 (Use 0.15 for medium grass, 0.25 for dense grass, and 0.35 for very dense Bermuda-type grass)

(Source for equations in items 11 through 14: Georgia Stormwater Management Manual)

**Filter Strips with Berm**

- 15. Size outlet pipes to ensure that the bermed area drains within 24 hours. Refer to TSS-01 Stormwater Wet Ponds for orifice sizing equations.
- 16. Specify grasses resistant to frequent inundation within the shallow ponding limit.
- 17. Berm material should consist of sand, gravel and sandy loam to encourage grass cover (Sand: ASTM C-33 fine aggregate concrete sand 0.02”-0.04”, Gravel: AASHTO M-43 ½” to 1”).
- 18. Size filter strip to contain the  $WQ_v$  within the wedge of water backed up behind the berm.
- 19. Maximum berm height is 12 inches.

**Filter Strips for Pretreatment**

- 20. A number of other structural controls, including bioretention areas and infiltration trenches, may utilize a filter strip as a pretreatment measure. The required length of the filter strip depends on the drainage area, imperviousness, and the filter strip slope. Table 6.1 provides sizing guidance for using filter strips for pretreatment. Filter strips used as pretreatment for coarse sediment for bioretention areas and infiltration trenches are not credited with removing TSS above and beyond the main treatment BMP.

**Table TSS-06-01 Sizing of Filter Strips for Pretreatment Only**

Parameter	Impervious Areas*				Pervious Areas (Lawns, etc.)**			
	< 2%	> 2%	< 2%	> 2%	< 2%	> 2%	< 2%	> 2%
<b>Maximum inflow approach length (feet)</b>	35		75		75		150	
<b>Filter strip slope (max = 6%)</b>	< 2%	> 2%	< 2%	> 2%	< 2%	> 2%	< 2%	> 2%
<b>Filter strip minimum length (feet)***</b>	10	15	20	25	10	12	30	36

\* 75 feet maximum impervious area flow length to filter strip.  
 \*\* 150 feet maximum pervious area draining to filter strip.  
 \*\*\*At least 25 feet is required for minimum pretreatment credit of 10% TSS removal. Fifty feet is required for obtaining 50% TSS removal credit.  
 (Adapted from Georgia Stormwater Management Manual)

**TSS – 06 SECTION 4: AS-BUILT CERTIFICATION**

After the filter strip has been constructed, the developer must have an as-built certification of the filter strip conducted by a registered Professional Engineer. The as-built certification verifies that the BMP was installed as designed and approved.



The following components must be addressed in the as-built certification:

1. Ensure design flows spread evenly across filter strip.
2. Ensure design slope is between 2% and 6%.
3. Verify dimensions of filter strip.

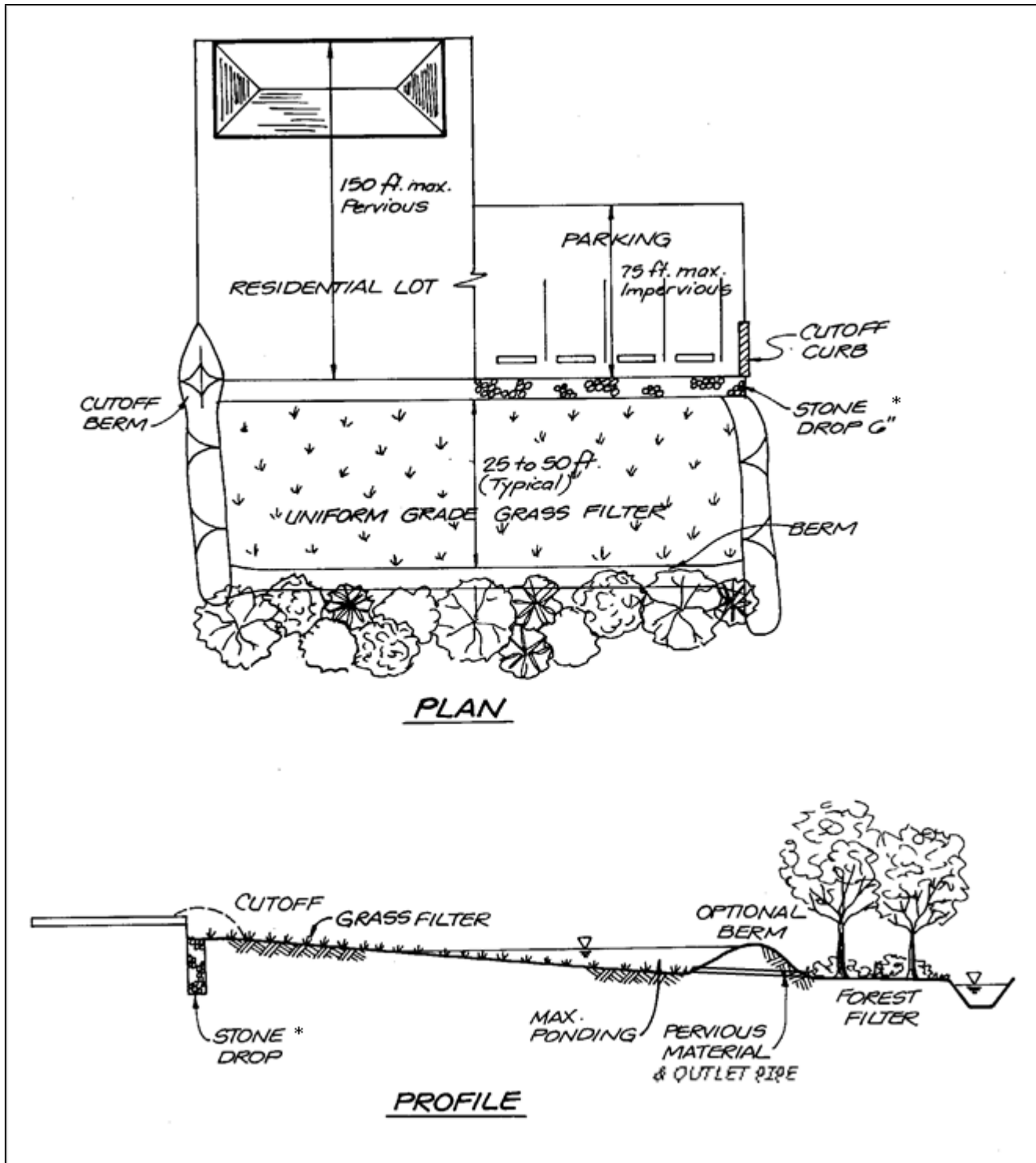
## TSS – 06 SECTION 5: MAINTENANCE

Each BMP must have a Hamilton County Water Quality Stormwater Management Facility I&M Storm Water Management Facilities Agreement submitted for approval and maintained and updated by the BMP owner. The Stormwater Management Facilities I&M Agreement must be completed and submitted to the Program with the Land Disturbance permit application. The Stormwater Management Facilities I&M Agreement is for the use of the BMP owner in performing routine inspections. The developer/owner is responsible for the cost of maintenance and annual inspections. The BMP owner must maintain and update the BMP inspections and maintenance plan.

At a minimum, the inspections and maintenance plan must address:

- ❖ Maintain a dense, healthy stand of grass and other vegetation by frequent mowing: grass heights of 3 to 5 inches should be maintained, with a maximum grass height of 8 inches;
- ❖ Repair erosion;
- ❖ Periodic sediment removal;
- ❖ In areas where compaction has greatly reduced infiltration rates tilling the soil may help and
- ❖ Revegetate as needed.





(Adapted from Georgia Stormwater Manual)

\* Stone drop or some other acceptable type of level spreader to achieve sheet flow.

Figure TSS-06-01 Filter Strip



## TSS – 06 SECTION 6: REFERENCES

ARC, 2001. Georgia Stormwater Management Manual Volume 2 Technical Handbook.

CDM, 2000. Metropolitan Nashville and Davidson County Stormwater Management Manual Volume 4 Best Management Practices.

City of Franklin, Stormwater Management Program. January 2014. *City of Franklin Stormwater Best Management Practices Manual*.



## Grass Channel



TSS - 07

Hamilton County



Water Quality Program

**Description:** Limited application structural control. Open channels that are vegetated and are designed to filter stormwater runoff, as well as slow water for treatment by another structural control.

### Components:

- Broad bottom channel on gentle slope (4% or less)
- Gentle side slopes (3:1 (H:V) or less)
- Dense vegetation that assists in stormwater filtration
- Check dams can be installed to maximize treatment

### Advantages/Benefits:

- Provides pretreatment if used as part of runoff conveyance system
- Provides partial infiltration of runoff in pervious soils
- Less expensive than curb and gutter
- Good for small drainage areas
- Relatively low maintenance requirements

### Reasons for Limited Use:

- Cannot alone achieve 80% removal of TSS; Fifty foot long channel is assumed to achieve 50% removal of TSS
- Must be carefully designed to achieve low flow rates in the channel (< 1.0 ft./s)
- May re-suspend sediment
- May not be acceptable for some areas because of standing water in channel

### Design considerations:

- Maximum drainage area of 5 acres
- Require slopes of 4% or flatter
- Runoff velocities must be non-erosive
- Appropriate for all but the most impermeable soils
- Requires vegetation that can withstand both relatively high velocity flows and wet and dry periods.

### Selection Criteria:

Water Quality  
80% TSS Removal

Pretreatment

Residential  
Subdivision

High Density /  
Ultra Urban Use

Other: Replaces curb and gutter

### Maintenance:

- Mow grass to 3 or 4 inches high
- Clean out sediment accumulation in channel
- Inspect for and correct formation of rills and gullies
- Ensure that vegetation is well-established

L Maintenance Burden

L = Low M = Moderate H = High





## TSS – 07 SECTION 1: DESCRIPTION

Grass channels, sometimes called biofilters, are conveyance channels that are designed to provide some treatment of runoff, as well as to slow down runoff velocities for treatment in other structural controls. Grass channels are appropriate for a number of applications including treating runoff from paved roads and from pervious areas.

Grass channels do not provide full water quality treatment because they are not designed with engineered filtration areas, as water quality swales (TSS-04) are. Because they are not enhanced for increased filtration and infiltration, they provide a lower TSS removal and are appropriate for limited application in combination with other structural controls.

Grass channels are able to infiltrate some runoff from small storms when situated in pervious soils. They provide other ancillary benefits such as reduction of impervious cover, accenting natural features, and reduced cost when compared with traditional curb and gutter.

The most important considerations when designing a grass channel are the channel capacity and erosion prevention. Runoff velocities must not exceed 1.0 foot per second during the peak discharge associated with the 2-year design storm. In addition, the vegetation height should provide 5 minutes of residence time in the channel.

Figure TSS-07-01 illustrates a grass channel. A grass channel consists of the following elements:

- ❖ A broad bottomed, trapezoidal or parabolic channel on a gentle slope (4% or less);
- ❖ Gently sloping sides (3:1 (H:V) or less);
- ❖ Hardy vegetation that can withstand relatively high velocities as well as a range of moisture conditions from very wet to dry; and
- ❖ Optional check dams to increase residence time.

## TSS – 07 SECTION 2: SITE AND DESIGN CONSIDERATIONS

The following design and site considerations must be incorporated into the grass channel design:

### General Considerations

1. The drainage area (contributing or effective) must be 5 acres or less. Runoff flows and volumes from larger drainage areas prevent proper filtration and infiltration of stormwater.
2. Grass channels should be designed on areas with slope of less than 4%. Slopes of 1% to 2% are recommended.
3. Grass channels can be used on most soils with some restrictions on the most impermeable soils. Grass channels should not be used on soils with infiltration rates less than 0.27 inches per hour if infiltration of small runoff flows is intended.
4. A grass channel should be designed to accommodate the water quality flow. Calculations for the water quality flow are as follows:



**Equation TSS-07-01**

$$Q_{wqp} = \frac{q_u APR_v}{640} = \frac{q_u WQ_v}{53.3}$$

Where:

- $Q_{wqp}$  = water quality peak flow (cfs)  
 $q_u$  = peak unit discharge in cfs/inch of rain/sq. mile of drainage  
 $1.1 * P * R_v$  = water quality treatment depth (inches) =  $1.1 * 1.0 * R_v$   
 $A$  = contributing drainage area (acres)

Larger flows should be accommodated by the channel if dictated by the surrounding conditions.

5. The channel should accommodate the 2-year, 24-hour storm without eroding.
6. Grass channels should have a trapezoidal or parabolic cross section with relatively flat side slopes (generally 3:1 or flatter).
7. The bottom of the channel should be between 2 and 6 feet wide. The minimum width ensures a minimum filtering surface for water quality treatment, and the maximum width prevents braiding, which is the formation of small channels within the swale bottom. The bottom width is a dependent variable in the calculation of velocity based on Manning's equation. If a larger channel is needed, the use of a compound cross section is recommended.
8. Runoff velocities must be nonerosive. The full-channel design velocity will typically govern.
9. A 5-minute residence time is recommended for the water quality peak flow. Residence time may be increased by check dams, reducing the slope of the channel, increasing the wetted perimeter, or planting a denser grass (raising the Manning's n).
10. The depth from the bottom of the channel to the groundwater should be at least 2 feet to prevent a moist swale bottom, or contamination of the groundwater.
11. Incorporation of check dams within the channel will maximize retention time.
12. Designers should choose a grass that can withstand relatively high velocity flows at the entrances, and both wet and dry periods.
13. A forebay is recommended in order to minimize the volume of sediment in the channel. (Refer to TSS-01 for forebay design.)
14. Provide an overflow for larger storm events.

**Grass Channel as Pretreatment**

A number of structural controls such as bioretention areas and infiltration trenches may be supplemented by a grass channel that serves as pretreatment for runoff flowing to the device. The lengths of grass channels vary based on the drainage area imperviousness and slope. Channels must be no less than 20 feet long. Table 7.1 below gives the minimum lengths for grass channels based on slope and percent imperviousness:



**Table TSS-07-01 Grass Channel Length Guidance**  
 (Source: Georgia Stormwater Management Manual)

Parameter	<= 33% Impervious		Between 34% and 66% Impervious		>= 67% Impervious	
	< 2%	> 2%	< 2%	> 2%	< 2%	> 2%
<b>Slope (max = 4%)</b>						
<b>Grass channel minimum length* (feet)</b>	25	40	30	45	35	50

\*assumes 2-foot wide bottom width

### TSS – 07 SECTION 3: AS-BUILT CERTIFICATION

After the grass channel has been constructed, an as-built certification of the grass channel must be prepared by a registered Professional Engineer and submitted to the Program. The as-built certification verifies that the BMP was installed as designed and approved.

The following components must be addressed in the as-built certification:

1. The channel must be adequately vegetated.
2. The channel flow velocities must not exceed 1.0 foot per second.
3. A mechanism for overflow for large storm events must be provided.

### TSS – 07 SECTION 4: MAINTENANCE

Each BMP must have a Hamilton County Water Quality Stormwater Management Facility I&M Storm Water Management Facilities Agreement submitted for approval and maintained and updated by the BMP owner. The Stormwater Management Facilities I&M Agreement must be completed and submitted to the Program with the Land Disturbance permit application. The Stormwater Management Facilities I&M Agreement is for the use of the BMP owner in performing routine inspections. The developer/owner is responsible for the cost of maintenance and annual inspections. The BMP owner must maintain and update the BMP inspections and maintenance plan. At a minimum, the inspections and maintenance plan must address:

1. Maintain grass height of 3 to 4 inches.
2. Remove sediment build up in channel bottom when it accumulates to 25% of original total channel volume.
3. Ensure that rills and gullies have not formed on side slopes. Correct if necessary.
4. Remove trash and debris build up.
5. Replant areas where vegetation has not been successfully established.



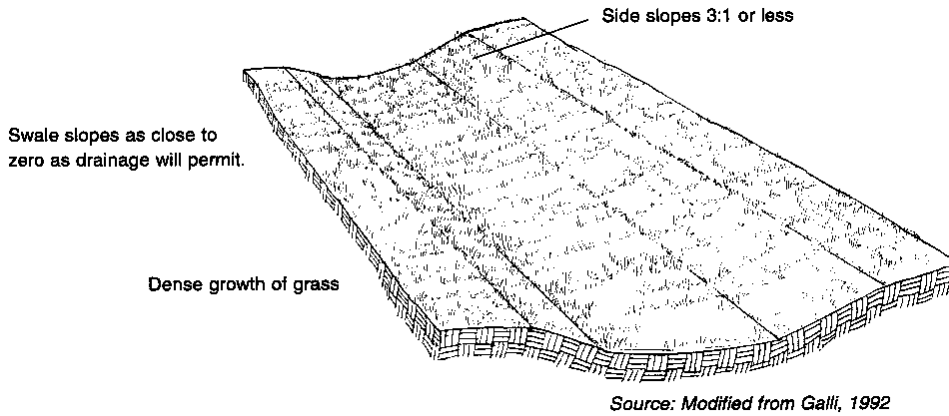
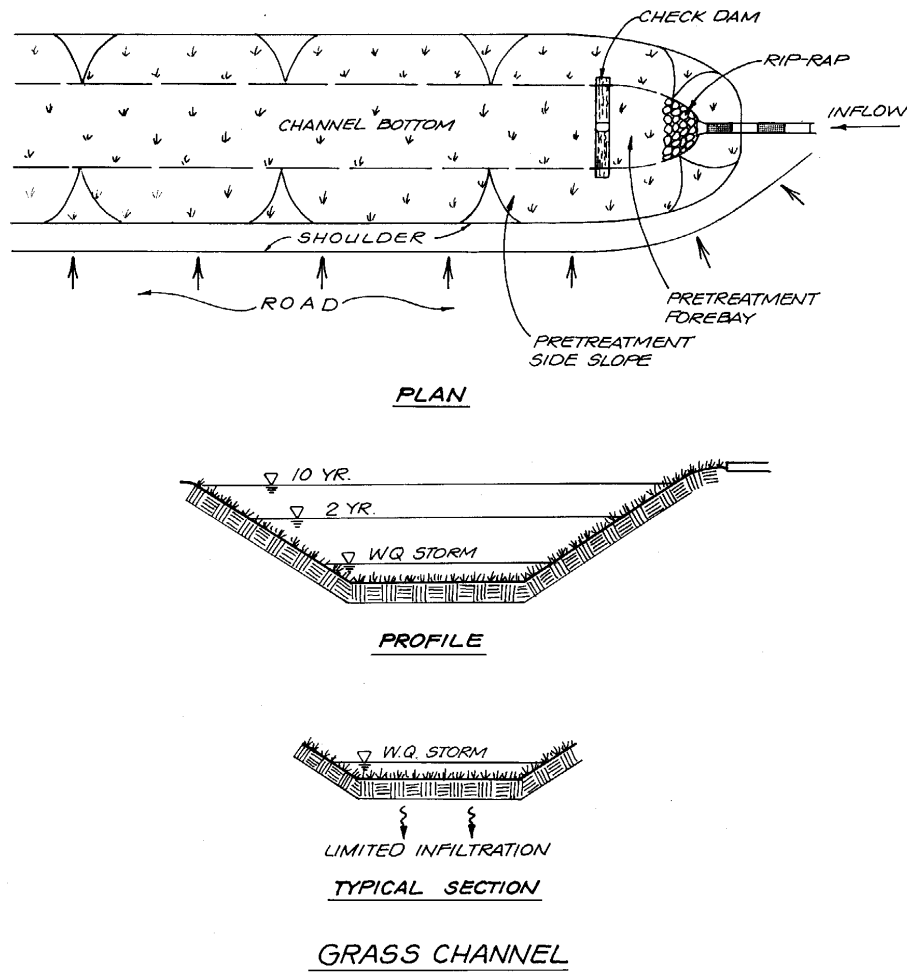


Figure TSS-07-01 Typical Grass Channel



(Source: Center for Watershed Protection)

Figure TSS-07-02 Grass Channel Schematic



## TSS – 07 SECTION 5: REFERENCES

ARC, 2001. Georgia Stormwater Management Manual Volume 2 Technical Handbook.

CDM, 2000. Metropolitan Nashville and Davidson County Stormwater Management Manual Volume 4 Best Management Practices.

City of Franklin, Stormwater Management Program. January 2014. *City of Franklin Stormwater Best Management Practices Manual*.

Claytor, R.A., and T.R. Schueler. 1996. Design of Stormwater Filtering Systems. The Center for Watershed Protection, Silver Spring, MD.



## Underground Sand Filter



TSS - 08

Hamilton County



Water Quality Program

**Description:** Design variant of the sand filter, located in an underground vault.

### Components:

Underground vault with three chambers

- (1) Sedimentation chamber
- (2) Filter chamber with protective screen and perforated drain system to third chamber
- (3) Overflow/outlet chamber

### Advantages/Benefits:

- High sediment trapping capability
- Additional pollutant removal as a result of sediment removal
- Precast concrete shells available, which decrease construction costs

### Disadvantages/Limitations:

- Intended for space-limited applications
- High maintenance requirements

### Design considerations:

- Drains highly impervious areas, usually 1 acre or less
- Provide maintenance access to chambers
- Underground chamber must be water tight. Openings must be 1/16<sup>th</sup> inch or smaller to prevent mosquito intrusion

### Selection Criteria:

- Water Quality**  
80 % TSS Removal
- Accepts Hotspot**  
**Runoff**
- Residential**  
**Subdivision**
- High Density /**  
**Ultra Urban Use**

### Maintenance:

- Monitor water level in sand filter chamber.
- Sedimentation chamber should be cleaned out when the sediment depth reaches 12 inches.
- Remove accumulated oil and floatables in sedimentation chamber.

**H** **Maintenance**  
**Burden**

L = Low M = Moderate H = High





## TSS – 08 SECTION 1: DESCRIPTION

The underground sand filter is a variant of the sand filter located in an underground vault designed for high-density land use or ultra-urban applications where there is not enough space for a surface sand filter or other structural stormwater controls.

The underground sand filter is a three-chamber system (See Figure 8.1). The initial chamber is a sedimentation chamber that temporarily stores runoff and utilizes a wet pool to capture sediment. The sedimentation chamber is connected to the sand filter chamber by a submerged wall that protects the filter bed from floating oil and trash. The filter bed is 18 to 24 inches deep and may have a protective screen of gravel or permeable geotextile to limit clogging. The sand filter chamber also includes an underdrain system with capped inspection and clean out wells. Perforated drain pipes under the sand filter bed extend into a third chamber that collects filtered runoff. The  $WQ_v$  displaces part of the permanent pool as it flows into the facility and creates a temporary pool above the permanent pool. Flows beyond the filter capacity are diverted through an overflow weir.

## TSS – 08 SECTION 2: SITE AND DESIGN CONSIDERATIONS

Due to its location below the surface, underground sand filters have a high maintenance burden and should only be used where adequate inspection and maintenance can be ensured.

1. Underground sand filters are typically used on highly impervious sites of 1 acre or less. The maximum drainage area that should be treated by an underground sand filter is 5 acres.
2. Underground sand filters are typically constructed on-line, but can be constructed off-line. For off-line construction, the overflow between the second and third chambers is not included.
3. The underground vault should be tested for water tightness prior to placement of filter layers.
4. Adequate maintenance access must be provided to the sedimentation and filter bed chambers.
5. Compute the minimum permanent pool volume required in the sedimentation chamber as:

$$\text{Equation TSS-08-01} \\ V_w = A_s * 3 \text{ feet minimum}$$

Where:  $A_s$  = Surface Area, from TSS-03

6. Consult the design criteria for the perimeter sand filter (see TSS-09 for the underground filter sizing and design steps.)

## TSS – 08 SECTION 3: AS-BUILT CERTIFICATION

An as-built certification conducted by a registered Professional Engineer must be performed and submitted to the Program. The as-built certification verifies that the BMP was installed as designed and approved.

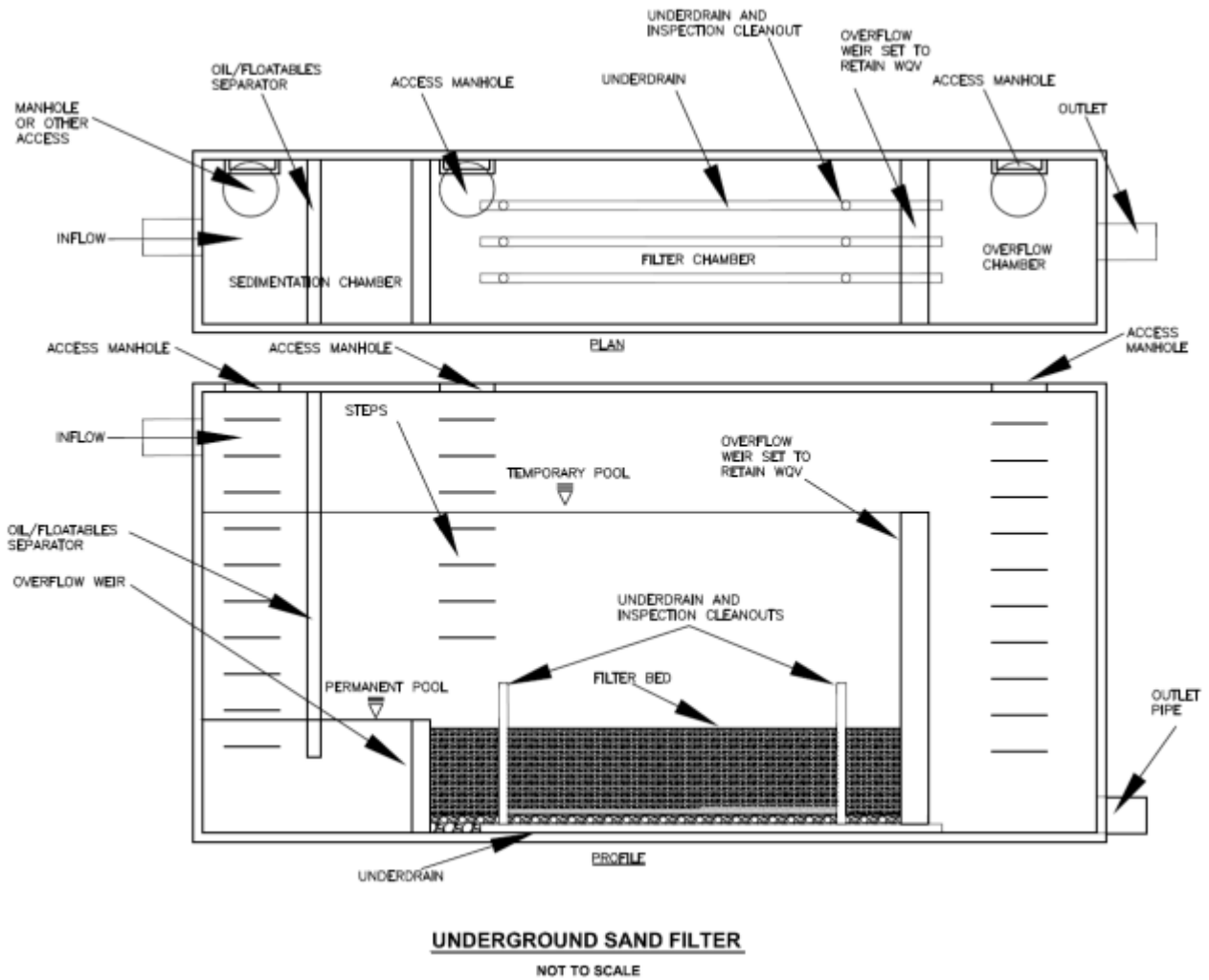
## TSS – 08 SECTION 4: INSPECTION AND MAINTENANCE

Each BMP must have a Hamilton County Water Quality Stormwater Management Facility I&M Storm Water Management Facilities Agreement submitted for approval and maintained and updated by the BMP owner. The Stormwater Management Facilities I&M Agreement must be completed and submitted to the Program with the Land Disturbance permit application. The Stormwater Management Facilities I&M Agreement is for the use of the

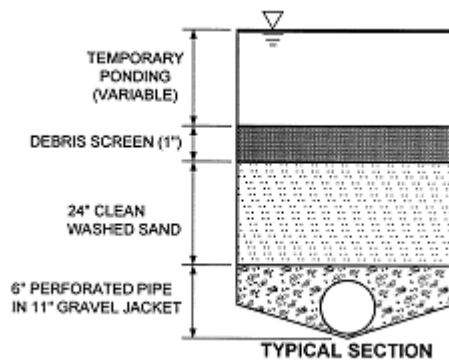


BMP owner in performing routine inspections. The developer/owner is responsible for the cost of maintenance and annual inspections. The BMP owner must maintain and update the BMP inspections and maintenance plan. At a minimum, the inspections and maintenance plan must address:

- ❖ Monitor water level in sand filter chamber.
- ❖ Sedimentation chamber should be cleaned out when the sediment depth reaches 12 inches.
- ❖ Remove accumulated oil and floatables in sedimentation chamber.
- ❖ Replace filter media when temporary pool is maintained for 40 hours following design storm (FHWA).



(Adapted from the Minnesota Stormwater Manual)



(Source: Center for Watershed Protection)

Figure TSS-08-01 Schematic of Underground Sand Filter





## TSS – 08 SECTION 5: REFERENCES

ARC, 2001. Georgia Stormwater Management Manual Volume 2 Technical Handbook.

Center for Watershed Protection, Accessed July 2005. Stormwater Manager's Resource Center. Manual Builder.  
[www.stormwatercenter.net](http://www.stormwatercenter.net).

City of Franklin, Stormwater Management Program. January 2014. *City of Franklin Stormwater Best Management Practices Manual*.

Minnesota Pollution Control Agency, Accessed January 2006. Minnesota Stormwater Manual.  
<http://www.pca.state.mn.us/water/stormwater/stormwater-manual.html>



## Perimeter Sand Filter



TSS - 09

Hamilton County



Water Quality Program

**Description:** Multi-chamber structure designed to treat stormwater runoff through filtration, using a sediment forebay, a sand bed as its primary filter media and an underdrain collection system (usually). Perimeter sand filters are located along the edge of impervious areas.

### Components:

- Forebay—settles coarse particles and trash
- Sand bed chamber—provides water quality treatment through sand filtration.
- Overflow chamber to outlet for larger storm flows

### Advantages/Benefits:

- Applicable to small drainage areas
- Good for highly impervious areas
- Good for water quality retrofits to existing developments

### Disadvantages/Limitations:

- Standing water raises mosquito concerns
- High maintenance burden
- Not recommended for areas with high sediment content in stormwater or clay/silt runoff areas
- Relatively costly
- Possible odor problems
- Typically needs to be combined with other controls to provide water quantity control

### Design considerations:

- Typically requires 2 to 6 feet of head
- Maximum contributing drainage area of 2 acres

### Selection Criteria:

- Water Quality**  
80 % TSS Removal
- Accepts Hotspot**  
**Runoff**
- Residential**  
**Subdivision**
- High Density /**  
**Ultra Urban Use**

### Maintenance:

- Inspect for clogging—rake first inch of sand
- Remove sediment from forebay-chamber
- Replace sand filter media as needed
- Clean spillway system(s)

**H** **Maintenance**  
**Burden**

L = Low M = Moderate H = High



## TSS – 09 SECTION 1: DESCRIPTION

The perimeter sand filter is an enclosed filter system typically constructed just below grade in a vault along the edge of an impervious area such as a parking lot. The filter captures and temporarily stores stormwater runoff, filtering it through a bed of sand. Runoff flows into the structure through a series of inlet grates located along the top of the filter. The system consists of a forebay (sedimentation chamber) and a sand bed (filtration) chamber. The first chamber is a forebay or sedimentation chamber, which removes floatables and heavy sediments. The second is the sand bed or filtration chamber, which removes additional pollutants by filtering the runoff through a sand bed. The filtered runoff is collected and returned to the conveyance system. In addition, since perimeter sand filters receive all runoff, as on-line controls, they include an overflow for flows larger than the water quality volume. A schematic of a perimeter sand filter is shown in Figure 9.1.

Because they have few site constraints beside head requirements, perimeter sand filters can be used on development sites where the use of other structural controls may be precluded. However, perimeter sand filter systems can be relatively expensive to construct and install and they have high maintenance requirements. Because perimeter sand filters have a permanent pool of standing water, they present vector concerns. Their use is limited to situations in which they can be inspected and maintained frequently enough to control mosquito breeding. In addition, although perimeter sand filter systems are designed as on-line systems, they do not control water quantity.

In perimeter sand filter systems, stormwater pollutants are removed through a combination of gravitational settling, filtration and adsorption. The filtration process effectively traps suspended solids and particulates. As solids are trapped in the sand bed, some reduction of associated pollutants such as biochemical oxygen demand (BOD), fecal coliform bacteria, and other pollutants may be achieved.

## TSS – 09 SECTION 2: SITE AND DESIGN CONSIDERATIONS

Two design variants of perimeter sand filters are the surface sand filter (TSS-03) and the underground sand filter (TSS-08).

### Location and Siting

1. The maximum drainage area for a perimeter sand filter is 2 acres.
2. Perimeter sand filter systems are generally applied to land uses with a high percentage of impervious surfaces. Sites with less than 50% imperviousness or with high clay/silt sediment loads must not use sand filters without adequate pretreatment because the sediment causes clogging and failure of the filter bed. Any disturbed areas within the sand filter facility drainage area should be identified and stabilized. Filtration controls should only be constructed after the construction site is stabilized.
3. Perimeter sand filters are typically sited along the edge, or perimeter, of an impervious area such as a parking lot.
4. Perimeter and filter systems are designed for intermittent flow and must be allowed to drain and aerate between rainfall events. They should not be used on sites with a continuous flow from groundwater, sump pumps, or other sources.

### General Design





5. A perimeter sand filter facility is a vault structure located just below grade level. Runoff enters the device through inlet grates along the top of the structure into the sediment forebay (or sedimentation chamber). Unlike the surface sand filter, the perimeter sand filter sediment forebay contains a permanent forebay volume. Runoff is discharged from the forebay through a weir into the sand bed chamber. After passing through the filter bed, runoff is collected by a perforated pipe and gravel underdrain system. An overflow must be provided for flows larger than the design storm.

#### Physical Specifications/Geometry

6. The entire treatment system (excluding the permanent pool in the forebay) must temporarily hold the  $WQ_v$  prior to filtration. Table 9.1 presents the design parameters and values for the perimeter sand filter. Figure 9.2 illustrates these design parameters.
7. The forebay must be sized to at least 50% of the computed  $WQ_v$ .
8. The filter area is sized based on the principles of Darcy's Law. A coefficient of permeability ( $k$ ) of 3.5 ft./day for sand should be used. The filter bed is typically designed to completely drain in  $\leq 36$  hours.
9. The filter media should consist of a 12- to 18-inch layer of clean washed medium sand (meeting ASTM C-33 concrete sand) on top of the underdrain system. See TSS-03, Figure 3.3 for a typical filter section.
10. The perimeter sand filter is equipped with a 6-inch perforated pipe (ASTM Schedule 40) underdrain in a gravel layer. The underdrain must have a minimum grade of 1/8 inch per foot (1% slope). Holes should be 3/8-inch diameter and spaced approximately 10 inches on center. A permeable filter fabric should be placed between the gravel layer and the filter media. Gravel should be clean washed aggregate with a maximum diameter of 3.5 inches and a minimum diameter of 1.5 inches with a void space of about 30%. Aggregate contaminated with soil shall not be used. Gravel layer and perforated underdrain piping must have infiltration rates at least twice as fast as the design infiltration rate of the sand bed.

#### Pretreatment/Inlets

11. Pretreatment of runoff in a sand filter system is provided by the forebay.
12. Inlets to surface sand filters are to be provided with energy dissipaters.

#### Outlet Structures

13. Outlet pipe is to be provided from the underdrain system to the facility discharge. Due to the slow rate of filtration, outlet protection is generally unnecessary (except for emergency overflows and spillways).
14. All flows enter the perimeter sand filter. However, flows larger than the water quality volume are not treated. They pass to an overflow chamber and outlet.

#### Maintenance Access

15. Adequate access through maintenance easements must be provided for all sand filter systems for inspection and maintenance. Access grates to the filter bed need to be included in a perimeter sand filter design. Facility designs must enable maintenance personnel to easily replace the upper layers of the filter media.

### TSS – 09 SECTION 3: AS-BUILT CERTIFICATION

An as-built certification conducted by a registered Professional Engineer must be performed and submitted to the Program. The as-built certification verifies that the BMP was installed as designed and approved.

### TSS – 09 SECTION 4: INSPECTION AND MAINTENANCE



Each BMP must have a Hamilton County Water Quality Stormwater Management Facility I&M Storm Water Management Facilities Agreement submitted for approval and maintained and updated by the BMP owner. The Stormwater Management Facilities I&M Agreement must be completed and submitted to the Program with the Land Disturbance permit application. The Stormwater Management Facilities I&M Agreement is for the use of the BMP owner in performing routine inspections. The developer/owner is responsible for the cost of maintenance and annual inspections. The BMP owner must maintain and update the BMP inspections and maintenance plan. At a minimum, the inspections and maintenance plan must address:

- ❖ Monitor water level in sand filter chamber.
- ❖ Sedimentation chamber should be cleaned out when the sediment depth reaches 12 inches.
- ❖ Remove accumulated oil and floatables in sedimentation chamber.
- ❖ Replace filter media when temporary pool is maintained for 40 hours following design storm (FHWA).

**Table TSS-09-01 Perimeter Sand Filter Design Parameters**

*(Adapted from the New Jersey Stormwater Best Management Practices Manual)*

<i>Parameter Description</i>	<i>Parameter</i>	<i>Parameter Value</i>
Total Temporary Volume in Forebay and Sand Bed Chamber <sup>1</sup>	WQ <sub>v</sub>	WQ <sub>v</sub> ; See Design Step #1
Approximate Temporary Sand Bed Volume <sup>2</sup>	V <sub>ST</sub>	(0.5) WQ <sub>v</sub>
Minimum Sand Bed Thickness	T <sub>S</sub>	18 inches
Sand Bed Design Porosity	n	0.3
Sand Bed Design Permeability	k	3.5 feet/day
Sand Bed Design Drain Time	t <sub>d</sub>	1.5 days, 36 hours max
Minimum Sand Bed Chamber Area	A <sub>S</sub>	See Design Step #6
Approximate Temporary Forebay and Sand Bed Chamber Volume <sup>3</sup>	V <sub>FT</sub>	(0.5) WQ <sub>v</sub>
Minimum Forebay Surface Area	A <sub>F</sub>	(0.05) WQ <sub>v</sub>
Maximum Temporary Sand Bed Depth <sup>4</sup>	D <sub>ST</sub>	See Design Step #3
Maximum Temporary Forebay Depth	D <sub>FT</sub>	See Design Step #3
Minimum Permanent Forebay Depth	D <sub>FP</sub>	2

1. Includes temporary storage volume in sand, but excludes storage volume in forebay permanent pool.

2. Includes temporary storage volume in sand.

3. Excludes storage volume in forebay permanent pool.

4. Measured from top of sand bed.



## TSS – 09 SECTION 5: DESIGN PROCEDURES

*Design of a sand filter is usually a trial and error process because of the number of variables involved.*

### Step 1. Compute the Water Quality Volume.

Calculate the Water Quality Volume ( $WQ_v$ ), which must be temporarily stored within the perimeter sand filter's entire treatment system, excluding the forebay permanent pool.

$$\text{Equation TSS-09-01}$$
$$WQ_v = 1.1 \times P \times R_v \times A / 12$$

Where:

$WQ_v$  = water quality treatment volume, ac-ft.

$P$  = 1.0 inch

$R_v$  = volumetric runoff coefficient (See Section 1 Chapter 3.1)

$A$  = contributing drainage area, acres

### Step 2. Determine approximate required volumes of the forebay and sand bed chambers.

Each should be equal to approximately  $0.5 WQ_v$ , as shown in Table 9.1.

### Step 3. Determine approximate temporary depths in sand bed ( $D_{ST}$ ) and forebay ( $D_{FT}$ ) for the $WQ_v$ .

The estimate will depend on and be based on analysis of site conditions including the difference between the invert elevation of the downstream conveyance system and the maximum ground elevation at filter facility. Make sure to include the minimum sand bed thickness ( $T_s$ ) and the permanent forebay depth ( $D_{FP}$ ) into the consideration for these temporary depths. Note that the maximum temporary depth in the sand bed zone ( $D_{ST}$ ) is measured from the top of the sand bed, while the maximum temporary forebay depth ( $D_{FT}$ ) is measured from the permanent forebay water surface.

### Step 4. Compute minimum forebay surface area ( $A_F$ ).

The minimum surface area is:

$$\text{Equation TSS-09-02}$$
$$A_F = 0.05 (WQ_v)$$

Where:

$A_F$  = forebay area

0.05 = a multiplier in units per area of volume ( $L^2/L^3$ )

### Step 5. Compute total temporary storage volume in the forebay ( $V_{FT}$ ).

From the maximum temporary depth in the forebay ( $D_{FT}$ ) from Step 3 and the minimum forebay area ( $A_F$ ) from Step 4, compute the total temporary storage volume in the forebay ( $V_{FT}$ ). Compare this volume with the approximate required forebay volume computed in Step 2. Adjust the maximum temporary forebay depth ( $D_{FT}$ ) and/or forebay area ( $A_F$ ) as necessary to achieve a total temporary forebay storage volume ( $V_{FT}$ ) as close as





practical to the required forebay volume from Step 2. While adjusting the forebay surface area ( $A_F$ ) by varying its length and width, remember that the forebay will be located immediately adjacent to the sand bed zone.

**Step 6. Compute sand bed chamber area ( $A_S$ ).**

The filter area is sized using the following equation (based on Darcy's Law):

$$A_S = \frac{WQ_v (T_S / [(k) (D_{ST}/2 + T_S) (T_D)]}{\text{Equation TSS-09-03}}$$

Where:

- $A_S$  = Sand Bed Surface Area (in square feet)
- $T_S$  = Thickness of Sand in Sand Bed (typically 18 inches, no more than 24 inches)
- $k$  = Coefficient of permeability of filter media (ft./day) (use 3.5 ft./day for sand)
- $D_{ST}$  = Maximum Temporary Sand Bed Depth (ft.)
- $t_d$  = Sand Bed Design Drain Time (1.5 days or 36 hours is recommended maximum)

See the Physical Specifications/Geometry section of the *Site and Design Considerations* for filter media specifications.

**Step 7. Compute total temporary storage volume in sand bed.**

$$V_{ST} = (A_S)(D_{ST}) + (A_S)(T_S)(n)$$

**Equation TSS-09-04**

Where:

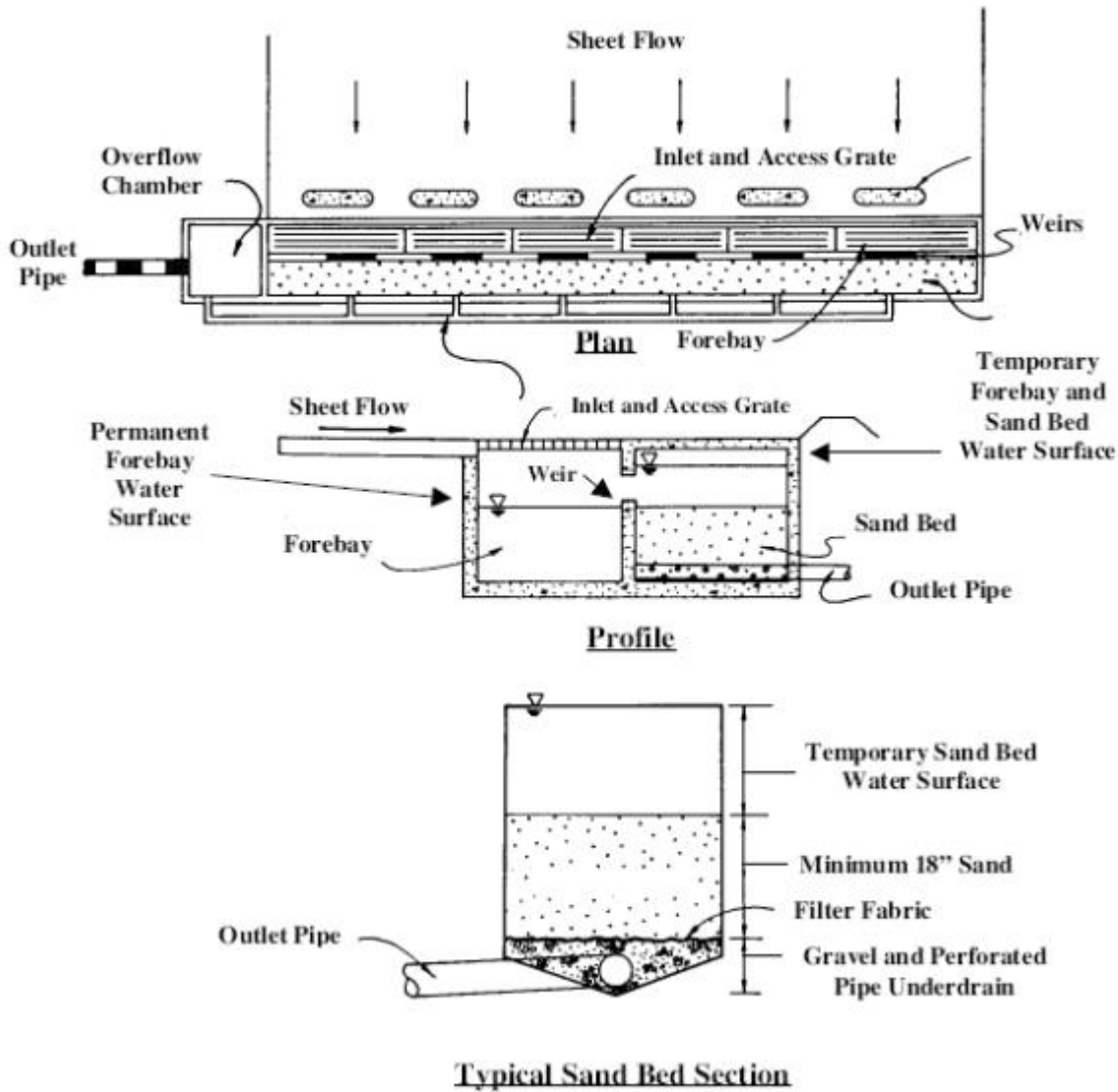
- $V_{ST}$  = Temporary Sand Bed Storage Volume (in cubic feet)
- $A_S$  = Sand Bed Surface Area (in square feet)
- $D_{ST}$  = Maximum Temporary Sand Bed Depth (ft.)
- $T_S$  = Thickness of Sand in Sand Bed, recommended 18 inches (in feet)
- $n$  = Sand Bed Design Porosity, recommended 0.3

**Step 8. Compare and adjust areas and volumes to achieve storage of  $WQ_v$  within the entire facility.**

Compare the total temporary sand bed storage volume ( $V_{ST}$ ) with the approximate required sand bed zone volume computed in Step 2. As shown on Table 9.1, this temporary sand bed storage volume should be approximately one half of the stormwater quality design storm runoff volume ( $WQ_v$ ). In addition, add the total temporary sand bed volume ( $V_{ST}$ ) to the total temporary forebay storage volume ( $V_{FT}$ ) to determine the total temporary storage volume in the sand filter. As shown in Table 9.1, this total temporary storage volume must equal the stormwater quality design storm runoff volume ( $WQ_v$ ). Adjust the maximum temporary sand bed depth ( $D_{ST}$ ) and/or sand bed area ( $A_S$ ) as necessary to achieve a total temporary sand bed storage volume ( $V_{ST}$ ) as close as practical to the required sand bed volume from Step 2 and a total filter volume equal to  $WQ_v$ .

**Step 9. Design inlets, underdrain system, overflow weirs, and outlet structures.**

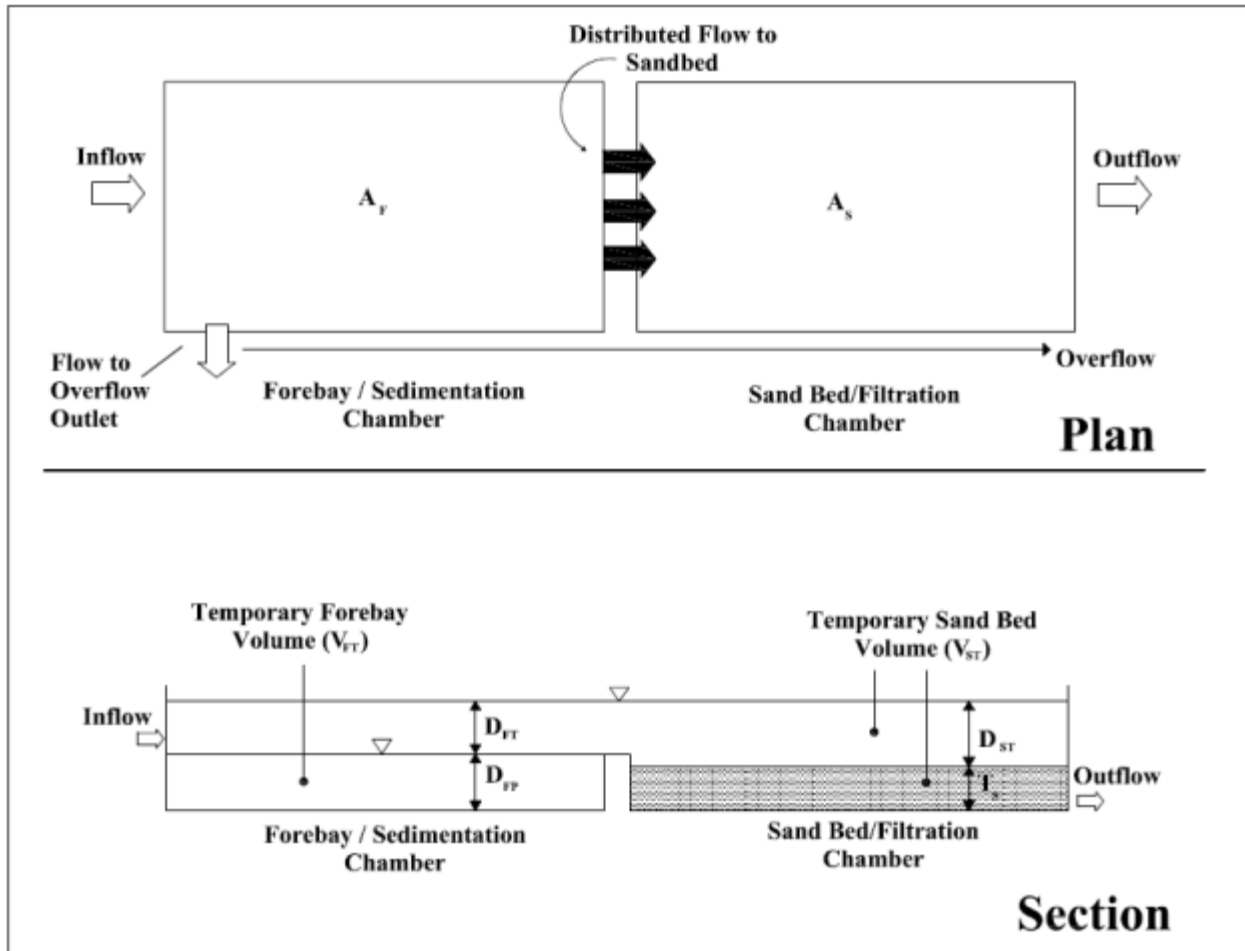
See *Site and Design Considerations* for more information on underdrain specifications and outlet structures. TSS-01 provides more information on sizing orifices, weirs, and outlets.



Note: Bottom may also be flat.

(Source: New Jersey Stormwater Best Management Practices Manual. 2003)

Figure TSS-09-01 Perimeter Sand Filter



(Source: New Jersey Stormwater Best Management Practices Manual, 2003)

Figure TSS-09-02 Schematic of Perimeter Sand Filter Showing Design Parameters





## TSS – 09 SECTION 6: REFERENCES

ARC, 2001. Georgia Stormwater Management Manual Volume 2 Technical Handbook.

Connecticut Department of Environmental Protection, 2004. Stormwater Quality Manual.

Center for Watershed Protection, Accessed July 2005. Stormwater Manager’s Resource Center. Manual Builder. [www.stormwatercenter.net](http://www.stormwatercenter.net).

City of Franklin, Stormwater Management Program. January 2014. *City of Franklin Stormwater Best Management Practices Manual*.

New Jersey Department of Environmental Protection, 2004. Stormwater Best Management Practices Manual.

StormwaterAuthority.com, Accessed January, 2006. “Sand and Organic Filters.” [www.stormwaterauthority.com](http://www.stormwaterauthority.com) .



## Organic Filter



TSS - 10

Hamilton County



Water Quality Program

**Description:** Usually a two chambered stormwater treatment practice and variant on a sand filter. The first chamber is for settling and the second is a filter bed of organic media. Large particles settle out in the first chamber and finer particles and other pollutants are removed in the second chamber.

### Components:

- Settling chamber—settles coarse particles and trash
- Filter chamber—provides water quality treatment by filtering other pollutants
- Spillway system(s) provide discharge control

### Advantages/Benefits:

- High pollutant removal capability
- Removal of dissolved pollutants is greater than sand filters due to cation exchange capacity until exchange capacity is exhausted

### Disadvantages/Limitations:

- Intended for hotspot or space-limited applications or for areas requiring enhanced pollutant removal capability
- Filter may require more frequent maintenance than most of the other stormwater controls
- Severe clogging potential if exposed soil surfaces exist upstream

### Design considerations:

- Minimum head requirement of 5 to 8 feet
- Contributing drainage area of up to 10 acres for organic filter
- Organic filter media with underdrain system
- In karst areas, use polyliner or impermeable membrane to seal bottom of earthen surface sand filter or use watertight structure

### Selection Criteria:

- Water Quality  
80 % TSS Removal
- Accepts Hotspot  
Runoff
- Residential  
Subdivision
- High Density /  
Ultra Urban Use

### Maintenance:

- Ensure that inlets and outlets are free from debris and not clogged.
- Check for sediment buildup in gravel bed.
- Remove gravel and sediment from cell; replace gravel and replant vegetation.

**H** Maintenance  
Burden

L = Low M = Moderate H = High



## TSS – 10 SECTION 1: DESCRIPTION

The organic filter is a design variant of the surface sand filter that uses organic materials such as leaf compost or a peat/sand mixture as the filter media. The organic material enhances pollutant removal by providing adsorption of contaminants such as soluble metals, hydrocarbons, and other organic chemicals until the adsorptive capacity is exhausted.

As with the surface sand filter, an organic filter consists of a pretreatment chamber, and one or more filter cells. Each filter cell is a layer of leaf compost or a peat/sand mixture, followed by filter fabric and a gravel/perforated pipe underdrain system. The filter bed and subsoils can be separated by an impermeable polyliner or concrete structure to prevent movement into groundwater.

Organic filters are typically used in densely developed areas, or in areas that require enhanced pollutant removal ability. Maintenance is typically higher than the surface sand filter facility due to the potential for clogging. In addition, organic filter systems have a higher head requirement than sand filters.

## TSS – 10 SECTION 2: SITE AND DESIGN CONSIDERATIONS

1. Organic filters are typically used on relatively small sites (up to 10 acres), to minimize potential clogging.
2. The minimum head requirement (elevation difference needed at a site from the inflow to the outflow) for an organic filter is 5 to 8 feet.
3. Organic filters can utilize a variety of organic materials as the filtering media. Two typical media bed configurations are the peat/sand filter and compost filter (see Figure 10.1). The peat filter includes an 18-inch 50/50 peat/sand mix over a 6-inch sand layer and can be optionally covered by 3 inches of topsoil and vegetation. The compost filter has an 18-inch compost layer. Both variants utilize a gravel underdrain system.
4. The type of peat used in a peat/sand filter is critically important. Fabric peat in which undecomposed fibrous organic material is readily identifiable is the preferred type. Hemic peat containing more decomposed material may also be used. Fabric peat made up of largely decomposed matter should *not* be used in an organic filter.
5. Typically, organic filters are designed as "off-line" systems, meaning that the water volume ( $WQ_v$ ) is diverted to the filter facility through the use of a flow diversion structure or flow splitter. Stormwater flows greater than the  $WQ_v$  are diverted to other controls or downstream using a diversion structure or flow splitter.
6. Consult the design criteria for the surface sand filter (TSS-03, *Sand Filters*) for the organic filter sizing and design steps. The coefficient of permeability for a peat/sand mix is 2.75 feet/day and compost is 8.7 feet/day, while pure sand is 3.5 feet/day (CWP, 1996).

## TSS – 10 SECTION 3: AS-BUILT CERTIFICATION

After the organic filter has been constructed, an as-built certification by a registered Professional Engineer must be submitted to the Program. The as-built certification verifies that the BMP was installed as designed and approved.





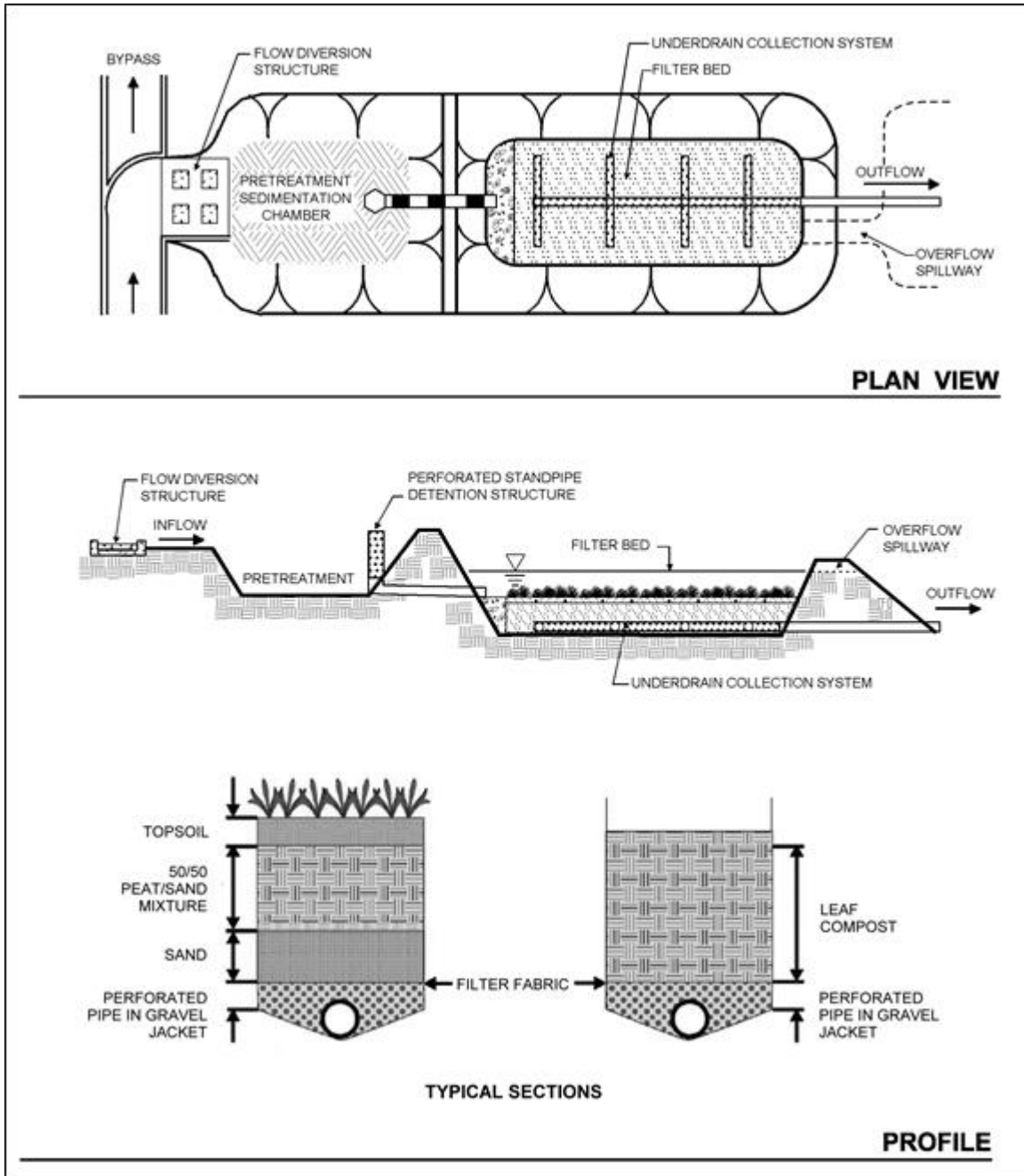
## TSS – 10 SECTION 4: MAINTENANCE

Each BMP must have a Hamilton County Water Quality Stormwater Management Facility I&M Storm Water Management Facilities Agreement submitted for approval and maintained and updated by the BMP owner. The Stormwater Management Facilities I&M Agreement must be completed and submitted to the Program with the Land Disturbance permit application. The Stormwater Management Facilities I&M Agreement is for the use of the BMP owner in performing routine inspections. The developer/owner is responsible for the cost of maintenance and annual inspections. The BMP owner must maintain and update the BMP inspections and maintenance plan. At a minimum, the inspections and maintenance plan must address:

1. Inspect for clogging—rake upper stratum of media as needed.
2. Remove sediment from forebay-chamber.
3. Replace organic filter media as needed.
4. Clean spillway system(s).

## TSS – 10 SECTION 5: DESIGN PROCEDURES

See TSS-03 *Surface Sand Filter*, surface sand filter sections, for additional guidance.



(Source: Center for Watershed Protection)

Figure TSS-10-01 Schematic of Organic Filter



## TSS – 10 SECTION 6: REFERENCES

ARC, 2001. Georgia Stormwater Management Manual Volume 2 Technical Handbook.

City of Franklin, Stormwater Management Program. January 2014. *City of Franklin Stormwater Best Management Practices Manual*.

Connecticut Department of Environmental Protection, 2004. Stormwater Quality Manual.

Federal Highway Administration (FHWA), United States Department of Transportation. Stormwater Best Management Practices in an Ultra-Urban Setting: Selection and Monitoring. Accessed January 2006.  
<http://www.fhwa.dot.gov/environment/ultraurb/index.htm>

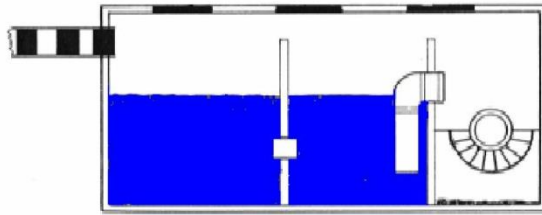
New Jersey Department of Environmental Protection, 2004. Stormwater Best Management Practices Manual.

StormwaterAuthority.com, Accessed January, 2006. "Sand and Organic Filters." [www.stormwaterauthority.com](http://www.stormwaterauthority.com) .





## Gravity (Oil Grit) Separator



TSS - 11

Hamilton County



Water Quality Program

**Description:** Hydrodynamic separation device designed to remove settleable solids, oil and grease, debris and floatables from stormwater runoff through gravitational settling and trapping of pollutants. Facilities with fueling and parking lots containing over 400 spaces require a more advanced separator with coalescing tubes/plates designed to provide a surface that minute oil globules are attracted to and can agglomerate upon. The coalesced oil then rises to the surface to be skimmed.

### Components:

- Inlet chamber
- Separation and oil storage chamber
- Enhanced components such as swirl concentrator chamber and coalescing filter (in high-risk areas)
- Outlet chamber

### Advantages/Benefits:

- Good for land uses that are hotspots for hydrocarbons
- Pretreatment for water quality
- Coalescing systems can remove oil particles down to the 20 micron range, while conventional device removes down to the 150 micron level.

### Disadvantages/Limitations:

- Cannot alone achieve the 80% TSS removal target
- Intended for hotspot, space-limited or pretreatment applications
- Limited performance data
- Dissolved pollutants are not removed
- Frequent maintenance required

### Design Considerations:

- Intended for the removal of settleable solids (grit and sediment) and floatable matter, including oil and grease
- Access point for maintenance required
- Performance dependent on design and frequency of inspection and cleanout of unit
- Openings to device must be 1/16 inch or less to prevent mosquito intrusion and breeding
- Install as an off-line device unless size of separator can be matched to smaller drainage area
- Install inspection/collection manhole on downstream side to provide easy access for sampling of effluent.

### Selection Criteria:

- Water Quality  
80 % TSS Removal
- Accepts Hotspot  
Runoff
- Residential  
Subdivision
- High Density /  
Ultra Urban Use

### Maintenance:

- Inspect the gravity separator unit.
- Clean out sediment, oil and grease, and floatables, using catch basin cleaning equipment (vacuum pumps). Manual removal may be necessary.

**H** Maintenance  
Burden

L = Low M = Moderate H = High



## TSS – 11 SECTION 1: DESCRIPTION

Gravity separators (also known as oil-grit separators) are hydrodynamic separation devices that are designed to remove grit and heavy sediments, oil and grease, debris and floatable matter from stormwater runoff through gravitational settling and trapping. Gravity separator units contain a permanent pool of water and typically consist of an inlet chamber, separation/storage chamber, and an access port for maintenance purposes. Runoff enters the inlet chamber where heavy sediments and solids drop out. The flow moves into the main gravity separation chamber, where further settling of suspended solids takes place. Oil and grease are skimmed and stored in a waste oil storage compartment for future removal. After moving into the outlet chamber, the clarified runoff is then discharged.

In “hot-spot” areas (fueling areas and large parking lots with over 400 spaces), separators are required to be equipped with coalescing tubes/plates. These tubes/plates provide a media in which minute oil globules can agglomerate to aid in the separation process. Oil that agglomerates around the coalescing tubes/plates can easily be skimmed through the gravity process.

When used for oil removal, the performance of these systems is based primarily on the relatively low solubility of petroleum products in water and the difference between the specific gravity of water and the specific gravities of petroleum compounds. Gravity separators are not designed to separate other products such as solvents, detergents, or dissolved pollutants. The typical gravity separator unit may be enhanced with a pretreatment swirl concentrator chamber, coalescing tubes/plates, oil draw-off devices that continuously remove the accumulated light liquids, and flow control valves regulating the flow rate into the unit.

Gravity separators are best used in commercial, industrial and transportation land uses and are intended primarily as a pretreatment measure for high-density or ultra-urban sites or for use in hydrocarbon hotspots such as gas stations and areas with high vehicular traffic. However, gravity separators cannot be used for the removal of dissolved or emulsified oils and pollutants such as coolants, soluble lubricants, glycols and alcohols, or in waste streams that contain detergents or other chemical-laden wastes.

## TSS – 11 SECTION 2: SITE AND DESIGN CONSIDERATIONS

Since resuspension of accumulated sediments is possible during heavy storm events, gravity separator units are typically installed off-line. Gravity separators are available as prefabricated proprietary systems from a number of commercial vendors.

1. The use of gravity (oil-grit) separators should be limited to the following applications:
  - ❖ Pretreatment for other structural stormwater controls
  - ❖ High-density, ultra urban or other space-limited development sites
  - ❖ Hotspot areas where the control of grit, floatables, and/or oil and grease are required
2. Gravity separators are typically used for areas less than 5 acres. It is recommended that the contributing area to any individual gravity separator be limited to 1 acre or less of impervious cover.
3. Gravity separator systems can be installed in almost any soil or terrain. Since these devices are underground, appearance is not an issue and public safety risks are low.
4. Gravity separators are flowrate-based devices. This contrasts with most other stormwater structural controls, which are sized based on capturing and treating a specific volume.



5. Gravity separator units are typically designed to bypass runoff flows in excess of the design flow rate. Some designs have built-in high flow bypass mechanisms. Other designs require a diversion structure or flow splitter ahead of the device in the drainage system. An adequate outfall must be provided.
6. The separation chamber should provide for three separate storage volumes:
  - ❖ A volume for separated oil storage
  - ❖ A volume for settleable solids accumulation at the bottom of the chamber
  - ❖ A volume required to give adequate flow-through detention time for separation of oil and sediment from the stormwater flow
7. The total wet storage of the gravity separator unit should be at least 400 cubic feet per contributing impervious acre.
8. The minimum depth of the permanent pools should be 4 feet.
9. Horizontal velocity through the separation chamber should be 1 to 3 ft./min or less. No velocities in the device should exceed the entrance velocity.
10. A trash rack should be included in the design to capture floating debris, preferably near the inlet chamber to prevent debris from becoming oil impregnated.
11. Ideally, a gravity separator design will provide an oil draw-off mechanism to a separate chamber or storage area.
12. Adequate maintenance access to each chamber must be provided for inspection and cleanout of a gravity separator unit.
13. Gravity separator units should be watertight to prevent possible groundwater contamination.
14. The design criteria and specifications of a proprietary gravity separator unit should be obtained from the manufacturer.

### TSS – 11 SECTION 3: AS-BUILT CERTIFICATION

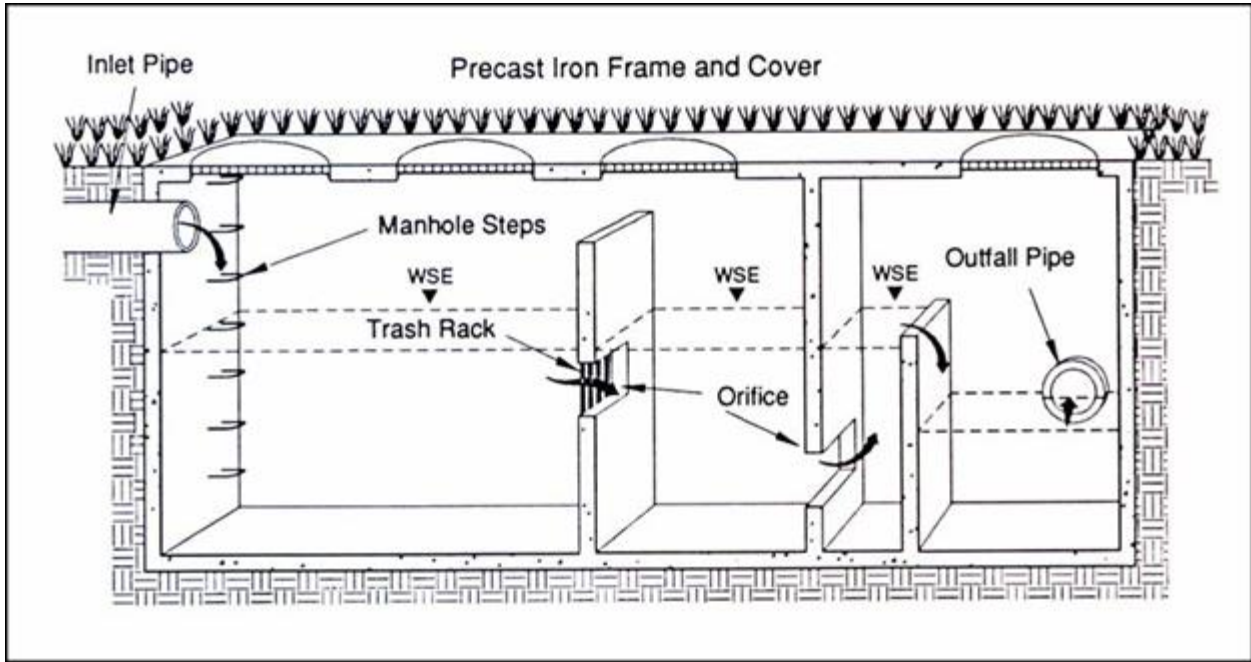
After the hydrodynamic device has been constructed, an as-built certification must be performed by a registered Professional Engineer and submitted to the Program. The as-built certification verifies that the BMP was installed as designed and approved.

### TSS – 11 SECTION 4: MAINTENANCE

Each BMP must have a Hamilton County Water Quality Stormwater Management Facility I&M Storm Water Management Facilities Agreement submitted for approval and maintained and updated by the BMP owner. The Stormwater Management Facilities I&M Agreement must be completed and submitted to the Program with the Land Disturbance permit application. The Stormwater Management Facilities I&M Agreement is for the use of the BMP owner in performing routine inspections. The developer/owner is responsible for the cost of maintenance and annual inspections. The BMP owner must maintain and update the BMP inspections and maintenance plan. At a minimum, the inspections and maintenance plan must address:

1. Additional maintenance requirements for a proprietary system should be obtained from the manufacturer.
2. Proper disposal of oil, solids and floatables removed from the gravity separator must be ensured.





(Sources: NVRC, 1992)

Figure TSS-11-01 Schematics of Gravity (Oil-Grit) Separator



## TSS – 11 SECTION 6: REFERENCES

ARC, 2001. Georgia Stormwater Management Manual Volume 2 Technical Handbook.

CDM, 2000. Metropolitan Nashville and Davidson County Stormwater Management Manual Volume 4 Best Management Practices.

City of Franklin, Stormwater Management Program. January 2014. *City of Franklin Stormwater Best Management Practices Manual*.